



SystemVerilog 3.1a draft 5 **Language Reference Manual**

Accellera's Extensions to Verilog[®]

Abstract: a set of extensions to the IEEE 1364-2001 Verilog Hardware Description Language to aid in the creation and verification of abstract architectural level models



Editor's note:

Draft 5 reflects all changes made to the released SystemVerilog 3.1 LRM.

- ~~red strike through text~~ indicates text to be deleted from the released 3.1 LRM.
- black text with change bars indicates text that has been added in SV 3.1a/draft 1 through draft 4.
- blue text with change bars indicates text that has been added for SV 3.1a/draft 5.
- red text in boxes indicates editor notes that need to be resolved, or that the editor needs to implement in a future draft.



SystemVerilog 3.1a draft 5 Language Reference Manual

Accellera's Extensions to Verilog[®]

Abstract: a set of extensions to the IEEE 1364-2001 Verilog Hardware Description Language to aid in the creation and verification of abstract architectural level models

This is a preliminary draft for review and development purposes within Accellera only. Information within this document has not been approved by Accellera, and is subject to change.



Copyright © 2002, 2003, 2004 by Accellera Organization, Inc.
1370 Trancas Street #163
Napa, CA 94558
Phone: (707) 251-9977
Fax: (707) 251-9877

All rights reserved. No part of this document may be reproduced or distributed in any medium whatsoever to any third parties without prior written consent of Accellera Organization, Inc.

Verilog is a registered trademark of Cadence Design Systems, San Jose, CA

Acknowledgements

This SystemVerilog Language Reference Manual was developed by experts from many different fields, including design and verification engineers, Electronic Design Automation (EDA) companies, EDA vendors, and members of the IEEE 1364 Verilog standard working group.

The SystemVerilog Language Reference Manual (LRM) was specified by the Accellera SystemVerilog committee. Four subcommittees worked on various aspects of the SystemVerilog 3.1 specification:

- The Basic/Design Committee (SV-BC) worked on errata extensions to the design features of SystemVerilog 3.1.
- The Enhancement Committee (SV-EC) worked on errata and extensions to the design features of SystemVerilog 3.1.
- The Assertions Committee (SV-AC) worked on errata and extensions to the assertion features of SystemVerilog 3.1.
- The C Application Programming Interface (API) Committee (SV-CC) worked on errata and extensions to the Direct Programming Interface (DPI), the assertions and coverage APIs and the VPI features of SystemVerilog 3.1.

LRM 196

The committee chairs were:

Vassilios Gerousis, SystemVerilog 3.1 and 3.1a Committee General Chair

Basic/Design Committee

Johny Srouji, SystemVerilog 3.1 and 3.1a Chair

Karen Pieper, SystemVerilog 3.1 and 3.1a Co-Chair

Enhancement Committee

David Smith, SystemVerilog 3.1 and 3.1a Chair

Stefen Boyd, SystemVerilog 3.1 Co-Chair

Neil Korpusik, SystemVerilog 3.1a Co-Chair

Assertions Committee

Faisal Haque, SystemVerilog 3.1 and 3.1a Chair

Steve Meier, SystemVerilog 3.1 Co-Chair

Arif Samad, SystemVerilog 3.1a Co-Chair

C API Committee

Swapnajt Mitra, SystemVerilog 3.1 and 3.1a Chair

Ghassan Khoory, SystemVerilog 3.1 and 3.1a Co-Chair

Stuart Sutherland, SystemVerilog 3.1 and 3.1a Language Reference Manual Editor

Stefen Boyd, SystemVerilog 3.1 BNF Annex. Editor

Brad Pierce, SystemVerilog 3.1a BNF Annex Editor

Committee members included (listed alphabetically by last name)

SystemVerilog 3.1/3.1a Basic/Design Committee	SystemVerilog 3.1/3.1a Enhancement Committee	SystemVerilog 3.1/3.1a Assertions Committee	SystemVerilog 3.1/3.1a C API Committee
Kevin Cameron+	Stefen Boyd*+	Roy Armoni+++	John Amouroux+++
Cliff Cummings*+++	Dennis Brophy+++	Surrendra Dudani+++	Kevin Cameron+++
Dan Jacobi+++	Michael Burns+++	Cindy Eisner+	Ralph Duncan++
Jay Lawrence+++	Kevin Cameron+	Harry Foster+	Charles Dawson++
Mark Hartoog++	Cliff Cummings*+++	Faisal Haque+++	João Geada+++
Peter Flake++	Peter Flake+	John Havlicek+++	Ghassan Khoory+++
Matt Maidment+++	Jeff Freedman+	Richard Ho+	Andrzej Litwiniuk+++
Francoise Martinolle*+++	Neil Korpusik+++	Adam Krolnik*+++	Avinash Mani++
Rishiyur Nikhil++	Jay Lawrence+++	David Lacey+	Francoise Martinolle*+++
Karen Pieper*+++	Francoise Martinolle*+	Joseph Lu+++	Swapnajt Mittra+++
Brad Pierce+++	Don Mills+	Erich Marschner+	Michael Rohleder+++
David Rich+++	Mehdi Mohtashemi+++	Steve Meier+	John Stickley+++
Steven Sharp*+	Phil Moorby+	Hillel Miller++	Stuart Swan+++
Johny Srouji+++	Karen Pieper*+	Prakash Narain+	Bassam Tabbara+++
Gord Vreugdenhil*+	Brad Pierce+++	Koushik Roy++	Kurt Takara+
Doug Warmke++	Dave Rich++	Arif Samad++	Doug Warmke+++
	Ray Ryan++	Andrew Seawright+	
	Arturo Salz+++	Bassam Tabbara+++	
	David Smith+++		
	Stuart Sutherland*+++		

* indicates this person was also an active member of the IEEE 1364 Verilog Standard Working Group

+ indicates this person was actively involved in SystemVerilog 3.1

++ indicates this person was actively involved in SystemVerilog 3.1a

+++ indicates this person was actively involved in SystemVerilog 3.1 and 3.1a

Table of Contents

Acknowledgements	iii
Table of Contents	v
Section 1 Introduction to SystemVerilog	1
Section 2 Literal Values.....	5
2.1 Introduction (informative)	5
2.2 Literal value syntax.....	5
2.3 Integer and logic literals	6
2.4 Real literals	6
2.5 Time literals	6
2.6 String literals.....	6
2.7 Array literals	7
2.8 Structure literals.....	7
Section 3 Data Types.....	9
3.1 Introduction (informative)	9
3.2 Data type syntax.....	10
3.3 Integer data types	11
3.4 Real and shortreal data types	12
3.5 Void data type	12
3.6chandle data type	12
3.7 String data type	13
3.8 Event data type.....	17
3.9 User-defined types	17
3.10 Enumerations	19
3.11 Structures and unions.....	24
3.12 Class.....	27
3.13 Singular and aggregate types	28
3.14 Casting	29
3.15 \$cast dynamic casting	30
3.16 Bit-stream casting	31
Section 4 Arrays	34
4.1 Introduction (informative)	34
4.2 Packed and unpacked arrays	34
4.3 Multiple dimensions	36
4.4 Indexing and slicing of arrays.....	36
4.5 Array querying functions	37
4.6 Dynamic arrays	37
4.7 Array assignment	39
4.8 Arrays as arguments.....	40
4.9 Associative arrays	41
4.10 Associative array methods	44
4.11 Associative array assignment.....	46
4.12 Associative array arguments	46
4.13 Associative array literals.....	46
4.14 Queues	47
4.15 Array manipulation methods	50

Section 5	Data Declarations	54
5.1	Introduction (informative)	54
5.2	Data declaration syntax.....	54
5.3	Constants.....	54
5.4	Variables	55
5.5	Scope and lifetime	56
5.6	Nets, regs, and logic.....	57
5.7	Signal aliasing.....	58
5.8	Type compatibility	60
Section 6	Attributes.....	63
6.1	Introduction (informative)	63
6.2	Default attribute type	63
Section 7	Operators and Expressions.....	64
7.1	Introduction (informative)	64
7.2	Operator syntax.....	64
7.3	Assignment operators	64
7.4	Operations on logic and bit types	65
7.5	Wild equality and wild inequality.....	65
7.6	Real operators	66
7.7	Size.....	66
7.8	Sign	66
7.9	Operator precedence and associativity	66
7.10	Built-in methods	67
7.11	Static Prefixes	68
7.12	Concatenation	69
7.13	Unpacked array expressions	69
7.14	Structure expressions	71
7.15	Tagged union expressions and member access	72
7.16	Aggregate expressions	74
7.17	Operator overloading	74
7.18	Streaming operators (pack / unpack)	76
7.19	Conditional operator	79
7.20	Set membership	79
Section 8	Procedural Statements and Control Flow.....	81
8.1	Introduction (informative)	81
8.2	Statements.....	81
8.3	Blocking and nonblocking assignments	82
8.4	Selection statements.....	83
8.5	Loop statements	89
8.6	Jump statements.....	91
8.7	Final blocks.....	91
8.8	Named blocks and statement labels	92
8.9	Disable	93
8.10	Event control.....	93
8.11	Level-sensitive sequence controls	95
8.12	Procedural assign and deassign removal	96
Section 9	Processes.....	97
9.1	Introduction (informative)	97
9.2	Combinational logic.....	97
9.3	Latched logic.....	98

9.4	Sequential logic.....	98
9.5	Continuous assignments	98
9.6	fork...join.....	99
9.7	Process execution threads	100
9.8	Process control.....	100
9.9	Fine-grain process control	102
Section 10 Tasks and Functions.....		104
10.1	Introduction (informative)	104
10.2	Tasks	105
10.3	Functions.....	107
10.4	Task and function argument passing	109
10.5	Import and export functions.....	112
Section 11 Classes.....		114
11.1	Introduction (informative)	114
11.2	Syntax	115
11.3	Overview.....	116
11.4	Objects (class instance).....	116
11.5	Object properties	117
11.6	Object methods	118
11.7	Constructors	118
11.8	Static class properties	119
11.9	Static methods.....	119
11.10	This	120
11.11	Assignment, re-naming and copying	120
11.12	Inheritance and subclasses	121
11.13	Overridden members.....	122
11.14	Super	122
11.15	Casting	123
11.16	Chaining constructors	123
11.17	Data hiding and encapsulation.....	124
11.18	Constant class properties	124
11.19	Abstract classes and virtual methods	125
11.20	Polymorphism: dynamic method lookup.....	126
11.21	Class scope resolution operator ::	126
11.22	Out of block declarations	127
11.23	Parameterized classes	128
11.24	Typedef class	129
11.25	Classes, structures, and unions	129
11.26	Memory management	130
Section 12 Random Constraints		131
12.1	Introduction (informative)	131
12.2	Overview.....	131
12.3	Random variables	134
12.4	Constraint blocks	135
12.5	Randomization methods	148
12.6	In-line constraints — randomize() with.....	150
12.7	Disabling random variables with rand_mode()	151
12.8	Controlling constraints with constraint_mode()	152
12.9	Dynamic constraint modification.....	153
12.10	In-line random variable control	153
12.11	Randomization of scope variables — std::randomize()	154

12.12	Random number system functions and methods	156
12.13	Random stability	158
12.14	Manually seeding randomize	160
12.15	Random weighted case — randcase	160
12.16	Random sequence generation — randsequence	161
Section 13 Inter-Process Synchronization and Communication		169
13.1	Introduction (informative)	169
13.2	Semaphores	169
13.3	Mailboxes	170
13.4	Parameterized mailboxes	173
13.5	Event	174
13.6	Event sequencing: wait_order()	175
13.7	Event variables	176
Section 14 Scheduling Semantics		179
14.1	Execution of a hardware model and its verification environment	179
14.2	Event simulation	179
14.3	The stratified event scheduler	179
14.4	The PLI callback control points	183
Section 15 Clocking Blocks		184
15.1	Introduction (informative)	184
15.2	Clocking block declaration	184
15.3	Input and output skews	186
15.4	Hierarchical expressions	187
15.5	Signals in multiple clocking blocks	188
15.6	Clocking block scope and lifetime	188
15.7	Multiple clocking blocks example	188
15.8	Interfaces and clocking blocks	189
15.9	Clocking block events	190
15.10	Cycle delay: ##	190
15.11	Default clocking	191
15.12	Input sampling	192
15.13	Synchronous events	192
15.14	Synchronous drives	193
Section 16 Program Block		196
16.1	Introduction (informative)	196
16.2	The program construct	196
16.3	Multiple programs	198
16.4	Eliminating testbench races	198
16.5	Blocking tasks in cycle/event mode	199
16.6	Program control tasks	199
Section 17 Assertions		201
17.1	Introduction (informative)	201
17.2	Immediate assertions	201
17.3	Concurrent assertions overview	203
17.4	Boolean expressions	204
17.5	Sequences	206
17.6	Declaring sequences	209
17.7	Sequence operations	212
17.8	Manipulating data in a sequence	233

17.9	Calling subroutines on match of a sequence	237
17.10	System functions	238
17.11	The property definition Declaring properties	239
17.12	Multiple clock support	246
17.13	Concurrent assertions	253
17.14	Clock resolution	260
17.15	Binding properties to scopes or instances	265
17.16	The expect statement	267
Section 18 Hierarchy.....		269
18.1	Introduction (informative)	269
18.2	Packages	269
18.3	Compilation unit support	273
18.4	Top-level instance	274
18.5	Module declarations	275
18.6	Nested modules	275
18.7	Extern modules	277
18.8	Port declarations	278
18.9	List of port expressions	279
18.10	Time unit and precision	280
18.11	Module instances	281
18.12	Port connection rules	284
18.13	Name spaces	286
18.14	Hierarchical names	287
Section 19 Interfaces.....		288
19.1	Introduction (informative)	288
19.2	Interface syntax	289
19.3	Ports in interfaces	293
19.4	Modports	294
19.5	Interfaces and specify blocks	300
19.6	Tasks and functions in interfaces	300
19.7	Parameterized interfaces	306
19.8	Virtual interfaces	308
19.9	Access to interface objects	312
Section 20 Coverage		314
20.1	Introduction (informative)	314
20.2	Defining the coverage model: covergroup	315
20.3	Using covergroup in classes	317
20.4	Defining coverage points	319
20.5	Defining cross coverage	324
20.6	Specifying coverage options	328
20.7	Predefined coverage methods	333
20.8	Predefined coverage system tasks and functions	333
20.9	Organization of option and type_option members	333
Section 21 Parameters		335
21.1	Introduction (informative)	335
21.2	Parameter declaration syntax	336
Section 22 Configuration Libraries.....		339
22.1	Introduction (informative)	339
22.2	Libraries	339

Section 23 System Tasks and System Functions	340
23.1 Introduction (informative)	340
23.2 Elaboration-time typeof function	340
23.3 Typename function	340
23.4 Expression size system function	341
23.5 Range system function	342
23.6 Shortreal conversions	342
23.7 Array querying system functions	343
23.8 Assertion severity system tasks	344
23.9 Assertion control system tasks	345
23.10 Assertion system functions	346
23.11 Random number system functions	346
23.12 Program control	347
23.13 Coverage system functions	347
23.14 Enhancements to Verilog-2001 system tasks	347
23.15 \$readmemb and \$readmemh	347
23.16 \$writememb and \$writememh	348
23.17 File format considerations for multi-dimensional unpacked arrays	348
23.18 System task arguments for multi-dimensional unpacked arrays	350
Section 24 VCD Data	351
Section 25 Compiler Directives	352
25.1 Introduction (informative)	352
25.2 `define macros	352
25.3 `include	353
Section 26 Features under consideration for removal from SystemVerilog	354
26.1 Introduction (informative)	354
26.2 Defparam statements	354
26.3 Procedural assign and deassign statements	354
Section 27 Direct Programming Interface (DPI)	356
27.1 Overview	356
27.2 Two layers of the DPI	357
27.3 Global name space of imported and exported functions	358
27.4 Imported tasks and functions	358
27.5 Calling imported functions	364
27.6 Exported functions	366
27.7 Exported tasks	366
27.8 Disabling DPI tasks and functions	366
Section 28 SystemVerilog Assertion API	368
28.1 Requirements	368
28.2 Extensions to VPI enumerations	368
28.3 Static information	369
28.4 Dynamic information	372
28.5 Control functions	375
Section 29 SystemVerilog Coverage API	377
29.1 Requirements	377
29.2 SystemVerilog real-time coverage access	378
29.3 FSM recognition	383
29.4 VPI coverage extensions	386

Section 30 SystemVerilog Data Read API	390
30.1 Introduction (informative)	390
30.2 Requirements	390
30.3 Extensions to VPI enumerations	391
30.4 VPI object type additions	392
30.5 Object model diagrams	394
30.6 Usage extensions to VPI routines	396
30.7 VPI routines added in SystemVerilog	397
30.8 Reading data	398
30.9 Optionally unloading the data	408
30.10 Reading data from multiple databases and/or different read library providers	408
30.11 VPI routines extended in SystemVerilog	411
30.12 VPI routines added in SystemVerilog	412
Section 31 SystemVerilog VPI Object Model	415
31.1 Introduction (informative)	415
31.2 Instances	417
31.3 Interfaces	418
31.4 Program	418
31.5 Module (supersedes IEEE 1364-2001 26.6.1)	419
31.6 Modport	420
31.7 Interface tf decl	420
31.8 Ports (supersedes IEEE 1364-2001 26.6.5)	421
31.9 Ref Obj	422
31.10 Variables (supersedes IEEE 1364-2001 section 26.6.8)	424
31.11 Var Select (supersedes IEEE 1364-2001 26.6.8)	426
31.12 Typespec	427
31.13 Variable Drivers and Loads (supersedes IEEE 1364-2001 26.6.23)	429
31.14 Instance Arrays (supersedes IEEE 1364-2001 26.6.2)	429
31.15 Scope (supersedes IEEE 1364-2001 26.6.3)	430
31.16 IO Declaration (supersedes IEEE 1364-2001 26.6.4)	431
31.17 Clocking Block	432
31.18 Class Object Definition	433
31.19 Constraint, constraint ordering, distribution,	434
31.20 Constraint expression	435
31.21 Class Variables	436
31.23 Named Events (supersedes IEEE 1364-2001 26.6.11)	438
31.24 Task, Function Declaration (supersedes IEEE 1364-2001 26.6.18)	439
31.25 Alias Statement	440
31.26 Frames (supersedes IEEE 1364-2001 26.6.20)	441
31.27 Threads	442
31.28 tf call (supersedes IEEE 1364-2001 26.6.19)	443
31.29 Module path, path term (supersedes IEEE 1364-2001 26.6.15)	444
31.30 Concurrent assertions	445
31.31 Property Decl	445
31.32 Property Specification	446
31.33 Multiclock Sequence Expression	447
31.34 Sequence Declaration	448
31.35 Sequence Expression	449
31.36 Attribute (supersedes IEEE 1364-2001 26.6.42)	450
31.37 Atomic Statement (supersedes IEEE 1364-2001 26.6.27)	451
31.38 If, if else, return, case, do while (supersedes IEEE 1364-2001 26.6.35, 26.6.36)	452
31.39 waits, disables, expect, foreach (supersedes IEEE 1364 26.6.38)	453
31.40 Expressions (supersedes IEEE 1364-2001 26.6.26)	454

31.41 Event control (supersedes IEEE 1364-2001 26.6.30).....	455
31.42 Event stmt (supersedes IEEE 1364-2001 26.6.27)	455
31.43 Process (supersedes IEEE 1364-2001 26.6.27)	455
31.44 Assignment (supersedes IEEE 1364-2001 26.6.28)	456
Annex A Formal Syntax.....	457
Annex B Keywords.....	497
Annex C Std Package	500
Annex D Linked Lists.....	502
Annex E DPI C-layer	508
Annex F Include files	533
Annex G Inclusion of Foreign Language Code	539
Annex H SystemVerilog Concurrent Assertions Semantics	543
Annex I sv_vpi_user.h	554
Annex J Glossary	567
Annex K Bibliography	569
Index	571

Section 1 Introduction to SystemVerilog

This document specifies the Accellera extensions for a higher level of abstraction for modeling and verification with the Verilog Hardware Description Language. These additions extend Verilog into the systems space and the verification space ~~and was~~. SystemVerilog is built on top of the work of the IEEE Verilog 2001 committee. LRM 204

Throughout this document:

- “Verilog” or “Verilog-2001” refers to the IEEE Std. 1364-2001 standard for the Verilog Hardware Description Language
- “SystemVerilog” refers to the Accellera extensions to the Verilog-2001 standard.

This document numbers the generations of Verilog as follows:

- **“Verilog 1.0”** is the IEEE Std. 1364-1995 Verilog standard, which is also called Verilog-1995
- **“Verilog 2.0”** is the IEEE Std. 1364-2001 Verilog standard, commonly called Verilog-2001; this generation of Verilog contains the first significant enhancements to Verilog since its release to the public in 1990
- **“SystemVerilog 3.x”** is Verilog-2001 plus an extensive set of high-level abstraction extensions, as defined in this document
 - SystemVerilog 3.0, approved as an Accellera standard in June 2002, includes enhancements primarily directed at high-level architectural modeling
 - SystemVerilog 3.1, approved as an Accellera standard in May, 2003, includes enhancements primarily directed at advanced verification and C language integration
 - SystemVerilog 3.1a, approved as an Accellera standard in **add final date**, includes corrections and clarifications to the SystemVerilog 3.1 manual, as well as some additional enhancements to Verilog such as VCD and PLI specifications for SystemVerilog constructs.

The Accellera initiative to extend Verilog is an ongoing effort under the direction of the Accellera HDL+ Technical Subcommittee. This committee will continue to define additional enhancements to Verilog beyond SystemVerilog 3.1a. LRM 204

SystemVerilog is built on top of Verilog 2001. SystemVerilog improves the productivity, readability, and reusability of Verilog based code. The language enhancements in SystemVerilog provide more concise hardware descriptions, while still providing an easy route with existing tools into current hardware implementation flows. The enhancements also provide extensive support for directed and constrained-random testbench development, coverage driven verification, and assertion based verification. LRM 204

SystemVerilog ~~3.0~~ adds ~~several~~ extended and new constructs to Verilog-2001, including:

- ~~C data types to provide better encapsulation and compactness of code~~
 - ~~int, typedef, struct, union, enum~~
- ~~Enhancements to existing Verilog constructs, to provide tighter specifications~~
 - ~~Extensions to always blocks to include linting type features~~
 - ~~Logic (0, 1, X, Z) and bit (0, 1) data types~~
 - ~~Automatic/static specification on a per variable instance basis~~
 - ~~Procedural break, continue, return~~
- ~~Interfaces to encapsulate communication and facilitate “Communication Oriented” design~~
- ~~Dynamic processes for modeling pipelines~~

- ~~A \$root top level hierarchy which can have global definitions~~

~~SystemVerilog 3.1 adds verification enhancements in the following important areas:~~

- ~~Verification Functionality: Reusable, reactive testbench data types and functions:~~
 - ~~Built-in types: string, associative array, and dynamic array~~
 - ~~Pass by reference subroutine arguments~~
- ~~Synchronization: Mechanisms for dynamic process creation, process control, and inter-process communication:~~
 - ~~Enhancements to existing Verilog events~~
 - ~~Built-in synchronization primitives: Semaphore, Mailbox~~
- ~~Classes: Object-Oriented mechanism that provides abstraction, encapsulation, and safe pointer capabilities~~
- ~~Dynamic Memory: Automatic memory management in a re-entrant environment that frees users from explicit de-allocation~~
- ~~Cycle-Based Functionality: Clocking blocks and cycle-based attributes that help reduce development, ease maintainability, and promote reusability:~~ LRM 137
 - ~~Cycle-based signal drives and samples~~
 - ~~Synchronous samples~~
 - ~~Race-free program context~~

~~Assertion mechanism for verifying design intent and functional coverage intent:~~

- ~~Property and sequence declarations~~
- ~~Assertions and Coverage statements with action blocks~~

~~SystemVerilog 3.1a adds several new constructs and changes:~~ LRM 58

- ~~Definition and support of a compilation unit~~
- ~~Packages containing declarations such as data, types, classes, tasks and functions~~
- ~~Separate compilation support~~
- ~~A compilation unit scope visible only within a compilation unit~~
- ~~Removal of the \$root global declaration space from SystemVerilog 3.1~~
- Extensions to data types for better encapsulation and compactness of code and for tighter specification LRM 204
 - C data types: int, typedef, struct, union, enum
 - other data types: bounded queues, logic (0, 1, X, Z) and bit (0, 1), tagged unions for safety
 - dynamic data types: string, classes, dynamic queues, dynamic arrays, associative arrays including automatic memory management freeing users from de-allocation issues
 - dynamic casting and bit-stream casting
 - Automatic/static specification on a per variable instance basis
- Extended operators for concise description
 - Wild equality and inequality
 - built-in methods to extend the language
 - operator overloading

- streaming operators
- set membership
- Extended procedural statements
 - pattern matching on selection statements for use with tagged unions
 - enhanced loop statements plus the `foreach` statement
 - C like jump statements: `return`, `break`, `continue`
 - final blocks that executes at the end of simulation (inverse of `initial`)
 - extended event control and sequence events
- Enhanced process control
 - Extensions to `always` blocks to include synthesis consistent simulation semantics
 - Extensions to `fork...join` to model pipelines and for enhanced process control
 - Fine-grain process control
- Enhanced tasks and functions
 - C like void functions
 - pass by reference
 - default arguments
 - pass by name
 - optional arguments
 - import/export functions for DPI (Direct Programming Interface)
- Classes: Object-Oriented mechanism that provides abstraction, encapsulation, and safe pointer capabilities
- Automated testbench support with random constraints
- Inter-process communication synchronization
 - semaphores
 - mailboxes
 - event extensions, event variables, and event sequencing
- Clarification and extension of the scheduling semantics
- Cycle-Based Functionality: Clocking blocks and cycle-based attributes that help reduce development, ease maintainability, and promote reusability:
 - cycle-based signal drives and samples
 - synchronous samples
 - race-free program context
- Assertion mechanism for verifying design intent and functional coverage intent.
 - property and sequence declarations
 - assertions and Coverage statements with action blocks
- Extended hierarchy support
 - packages for declaration encapsulation with `import` for controlled access

- compilation-unit scope nested modules and extern modules for separate compilation support
- extension of port declarations to support interfaces, events, and variables.
- \$root to provide unambiguous access using hierarchical references
- Interfaces to encapsulate communication and facilitate “Communication Oriented” design
- Functional coverage
- Direct Programming Interface (DPI) for clean, efficient interoperation with other languages (C provided)
- Assertion API
- Coverage API
- Data Read API
- VPI extensions for SystemVerilog constructs
- Concurrent assertion formal semantics

Section 2 Literal Values

2.1 Introduction (informative)

The lexical conventions for SystemVerilog literal values are extensions of those for Verilog. SystemVerilog adds literal time values, literal array values, literal structures and enhancements to literal strings.

2.2 Literal value syntax

```

time_literal5 ::= // from Annex A.8.4
    unsigned_number time_unit
    | fixed_point_number time_unit
time_unit ::= s | ms | us | ns | ps | fs | step
number ::= // from Annex A.8.7
    integral_number
    | real_number
integral_number ::=
    decimal_number
    | octal_number
    | binary_number
    | hex_number
decimal_number ::=
    unsigned_number
    | [ size ] decimal_base unsigned_number
    | [ size ] decimal_base x_digit { _ }
    | [ size ] decimal_base z_digit { _ }
binary_number ::= [ size ] binary_base binary_value
octal_number ::= [ size ] octal_base octal_value
hex_number ::= [ size ] hex_base hex_value
sign ::= + | -
size ::= non_zero_unsigned_number
non_zero_unsigned_number1 ::= non_zero_decimal_digit { _ | decimal_digit }
real_number1 ::=
    fixed_point_number
    | unsigned_number [ . unsigned_number ] exp [ sign ] unsigned_number
fixed_point_number1 ::= unsigned_number . unsigned_number
exp ::= e | E
unsigned_number1 ::= decimal_digit { _ | decimal_digit }
string_literal ::= " { Any_ASCII_Characters } " // from Annex A.8.8

```

LRM 125

Syntax 2-1—Literal values (excerpt from Annex A)

2.3 Integer and logic literals

Literal integer and logic values can be sized or unsized, and follow the same rules for signedness, truncation and left-extending as Verilog-2001.

SystemVerilog adds the ability to specify unsized literal single bit values with a preceding apostrophe ('), but without the base specifier. All bits of the unsized value are set to the value of the specified bit. In a self-determined context these literals have a width of 1 bit, and the value is treated as unsigned.

```
'0, '1, 'X, 'x, 'Z, 'z // sets all bits to this value
```

2.4 Real literals

The default type is **real** for fixed point format (e.g. 1.2), and exponent format (e.g. 2.0e10).

A cast can be used to convert literal **real** values to the **shortreal** type (e.g., `shortreal'(1.2)`). Casting is described in Section 3.14.

2.5 Time literals

Time is written in integer or fixed point format, followed without a space by a time unit (**fs ps ns us ms s step**). For example:

```
0.1ns
40ps
```

The time literal is interpreted as a **realtime** value scaled to the current time unit and rounded to the current time precision. Note that if a time literal is used as an actual parameter to a module or interface instance, the current time unit and precision are those of the module or interface instance.

2.6 String literals

A string literal is enclosed in quotes and has its own data type. Non-printing and other special characters are preceded with a backslash. SystemVerilog adds the following special string characters:

```
\v vertical tab
\f form feed
\a bell
\x02 hex number
```

A string literal must be contained in a single line unless the new line is immediately preceded by a \ (back slash). In this case, the back slash and the new line are ignored. There is no predefined limit to the length of a string literal.

A string literal can be assigned to ~~a character, or a packed array~~ **an integral type**, as in Verilog-2001. If the size differs, it is right justified. LRM 279

```
byte c1 = "A" ; bit [7:0] d = "\n" ;
bit [0:11] [7:0] c2 = "hello world\n" ;
```

A string literal can be assigned to an unpacked array of ~~characters, and a zero termination is added like in C bytes~~. If the size differs, it is left justified. LRM 279

```
byte c3 [0:12] = "hello world\n" ;
```

Packed and unpacked arrays are discussed in Section 4. The difference between string literals and array literals

is discussed in Section 2.7, which follows.

String literals can also be cast to a packed or unpacked array, which shall follow the same rules as assigning a literal string to a packed or unpacked array. Casting is discussed in Section 3.14.

SystemVerilog 3.1 also includes a **string** data type to which a string literal can be assigned. Variables of type string have arbitrary length; they are dynamically resized to hold any string. String literals are packed arrays (of a width that is a multiple of 8 bits), and they are implicitly converted to the string type when assigned to a string type or used in an expression involving string type operands (see Section 3.7).

2.7 Array literals

Array literals are syntactically similar to C initializers, but with the replicate operator (`{ { } }`) allowed.

```
int n[1:2][1:3] = {{0,1,2},{3{4}}};
```

The nesting of braces must follow the number of dimensions, unlike in C. However, replicate operators can be nested. The inner pair of braces in a replication is removed. A replication expression only operates within one dimension.

LRM 169

```
int n[1:2][1:3] = {2{{3{4, 5}}}}; // same as {{4,5,4,5,4,5},{4,5,4,5,4,5}}
```

If the type is not given by the context, it must be specified with a cast.

```
typedef int triple [1:3]; // 3 integers packed together
$mydisplay(triple' {0,1,2});
```

LRM 169

Array literals can also use their index or type as a key, and a default key value (see Section 7.13).

```
b = {1:1, default:0}; // indexes 2 and 3 assigned 0
```

2.8 Structure literals

Structure literals are syntactically similar to C initializers. Structure literals must have a type, either from context or a cast.

```
typedef struct {int a; shortreal b;} ab;
ab c;
c = {0, 0.0}; // structure literal type determined from
             // the left hand context (c)
```

Nested braces should reflect the structure. For example:

```
ab abarr[1:0] = {{1, 1.0}, {2, 2.0}};
```

Note that the C alternative `{1, 1.0, 2, 2.0}` is not allowed.

Structure literals can also use member name and value, or data type and default value (see Section 7.14):

```
c = {a:0, b:0.0}; // member name and value for that member
c = {default:0}; // all elements of structure c are set to 0
d = ab' {int:1, shortreal:1.0}; // data type and default value for all members
                               // of that type
```

When an array of structures is initialized, the nested braces should reflect the array and the structure. For example:

```
ab abarr[1:0] = {{1, 1.0}, {2, 2.0}};
```

Replicate operators can be used to set the values for the exact number of members. The inner pair of braces in a replication is removed.

LRM 169

```

struct {int X,Y,Z;} XYZ = {3{1}};
typedef struct {int a,b[4];} ab_t;
int a,b,c;
ab_t v1[1:0] [2:0];
v1 = {2{{3{a,{2{b,c}}}}}}};

```

```

/* expands to {{3{{a,{2{b,c}}}}}, {3{{a,{2{b,c}}}}}} */

```

LRM 215

```

/* expands to {{{a,{2{b,c}}},{a,{2{b,c}}},{a,{2{b,c}}}},
               {{a,{2{b,c}}},{a,{2{b,c}}},{a,{2{b,c}}}} } */

```

```

/* expands to {{{a,{b,c,b,c}},{a,{b,c,b,c}},{a,{b,c,b,c}}},
               {{a,{b,c,b,c}},{a,{b,c,b,c}},{a,{b,c,b,c}}}} */

```

Section 3 Data Types

3.1 Introduction (informative)

To provide for clear translation to and from C, SystemVerilog supports the C built-in types, with the meaning given by the implementation C compiler. However, to avoid the duplication of `int` and `long` without causing confusion, in SystemVerilog, `int` is 32 bits and `longint` is 64 bits. The C `float` type is called `shortreal` in SystemVerilog, so that it is not be confused with the Verilog-2001 `real` type.

Verilog-2001 has net data types, which can have 0, 1, X or Z, plus 7 strengths, giving 120 values. It also has variable data types such as `reg`, which have 4 values 0, 1, X, Z. These are not just different data types, they are used differently. SystemVerilog adds another 4-value data type, called `logic` (see Sections 3.3.2 and 5.6).

SystemVerilog 3.1 adds string, `chandle` and `class` data types, and enhances the Verilog `event` type and SystemVerilog 3.0 `enum` data types. SystemVerilog 3.1 also extends the user defined types by providing support for object-oriented class.

LRM 213

Verilog-2001 provides arbitrary fixed length arithmetic using `reg` data types. The `reg` type can have bits at X or Z, however, and so are less efficient than an array of bits, because the operator evaluation must check for X and Z, and twice as much data must be stored. SystemVerilog adds a `bit` type which can only have bits with 0 or 1 values. See Section 3.3.2 on 2-state data types.

Automatic type conversions from a smaller number of bits to a larger number of bits involve zero extensions if unsigned or sign extensions if signed, and do not cause warning messages. Automatic truncation from a larger number of bits to a smaller number does cause a warning message. Automatic conversions between `logic` and `bit` do not cause warning messages. To convert a logic value to a bit, 1 converts to 1, anything else to 0.

User defined types are introduced by `typedef` and must be defined before they are used. Data types can also be parameters to modules or interfaces, making them like class templates in object-oriented programming. One routine can be written to reverse the order of elements in any array, which is impossible in C and in Verilog.

Structures and unions are complicated in C, because the tags have a separate name space. SystemVerilog follows the C syntax, but without the optional structure tags.

See also Section 4 on arrays.

3.2 Data type syntax

```

data_type_common_item data_type ::= // from Annex A.2.2.1
    integer_vector_type [ signing ] { packed_dimension }
  | integer_atom_type [ signing ]
  + type_identifier { packed_dimension }
  | non_integer_type
  | struct_union [ packed [ signing ] ] { struct_union_member { struct_union_member } }
    { packed_dimension }14
  | enum [ enum_base_type ] { enum_name_declaration { , enum_name_declaration } }
  | string
  | chandle
  | virtual [ interface ] interface_identifier
  | [ class_scope | package_scope ] type_identifier { packed_dimension }
  | class_type
  | event
  | ps_covergroup_identifier

enum_base_type ::=
    integer_atom_type [ signing ]
  | integer_vector_type [ signing ] [ packed_dimension ]
  | type_identifier [ packed_dimension ]25

enum_name_declaration ::=
    enum_identifier [ [ integral_number [ : integral_number ] ] ] [ = constant_expression ]

class_scope ::= class_type ::
class_type ::=
    ps_class_identifier [ parameter_value_assignment ]
    { :: class_identifier [ parameter_value_assignment ] }

integer_type ::= integer_vector_type | integer_atom_type
integer_atom_type ::= byte | shortint | int | longint | integer | time
integer_vector_type ::= bit | logic | reg
non_integer_type ::= time | shortreal | real | realtime
net_type ::= supply0 | supply1 | tri | triand | trior | trio | tri1 | wire | wand | wor
signing ::= signed | unsigned
simple_type ::= integer_type | non_integer_type | ps_type_identifier

struct_union_member28 ::=
    { attribute_instance } data_type { packed_dimension }
    data_type_or_void list_of_variable_identifiers ;
  + { attribute_instance } void list_of_variable_identifiers ;

data_type_or_void ::= data_type | void

struct_union ::= struct | union [ tagged ]

variable_decl_assignment ::= // from Annex A.2.4
    variable_identifier variable_dimension [ = expression ]
  | variable_identifier dynamic_array_variable_identifier [ ] = new [ expression ] { (
variable_identifier ) } [ = dynamic_array_new ]
  | class_variable_identifier = new [ ( list_of_arguments ) ] [ = class_new ]
  | [ covergroup_variable_identifier ] = new [ ( list_of_arguments ) ]17

```

LRM 213
LRM 241
LRM 243
LRM 246
LRM 249

LRM 45
LRM 59
LRM 65
LRM 69
LRM 89
LRM 100

LRM 125

LRM 147

LRM 35

LRM 122

Syntax 3-1—data types (excerpt from Annex A)

3.3 Integer data types

SystemVerilog offers several integer data types, representing a hybrid of both Verilog and C data types:

Table 3-1: Integer data types

shortint	2-state SystemVerilog data type, 16 bit signed integer
int	2-state SystemVerilog data type, 32 bit signed integer
longint	2-state SystemVerilog data type, 64 bit signed integer
byte	2-state SystemVerilog data type, 8 bit signed integer or ASCII character
bit	2-state SystemVerilog data type, user-defined vector size
logic	4-state SystemVerilog data type, user-defined vector size
reg	4-state Verilog-2001 data type, user-defined vector size
integer	4-state Verilog-2001 data type, at least 32 bit signed integer
time	4-state Verilog-2001 data type, 64-bit integer

LRM 9

LRM 213

3.3.1 Integral types

The term integral is used throughout this document to refer to the data types that can represent a single basic integer data type, **packed array**, **packed struct**, **packed union**, **enum**, or **time**.

3.3.2 2-state (two-value) and 4-state (four-value) data types

Types that can have unknown and high-impedance values are called 4-state types. These are **logic**, **reg**, **integer** and **time**. The other types do not have unknown values and are called 2-state types, for example **bit** and **int**.

The difference between **int** and **integer** is that **int** is 2-state logic and **integer** is 4-state logic. 4-state values have additional bits that encode the X and Z states. 2-state data types can simulate faster, take less memory, and are preferred in some design styles.

3.3.3 Signed and unsigned data types

Integer types use integer arithmetic and can be signed or unsigned. This affects the meaning of certain operators such as '<', etc.

```
int unsigned ui;
int signed si;
```

The data types **byte**, **shortint**, **int**, **integer** and **longint** default to **signed**. The data types **bit**, **reg** and **logic** default to **unsigned**, as do arrays of these types.

Note that the **signed** keyword is part of Verilog-2001. The **unsigned** keyword is a reserved keyword in Verilog-2001, but is not utilized.

See also Section 7, on operators and expressions.

3.4 Real and shortreal data types

The `real`¹ data type is from Verilog-2001, and is the same as a C `double`. The `shortreal` data type is a SystemVerilog data type, and is the same as a C `float`.

3.5 Void data type

The `void` data type represents non-existent data. This type can be specified as the return type of functions, indicating no return value. [This type can also be used for members of tagged unions \(see Section 3.11\).](#)

LRM 213

3.6 handle data type

The `handle` data type represents storage for pointers passed using the DPI Direct Programming Interface (see Section 27). The size of this type is platform dependent, but shall be at least large enough to hold a pointer on the machine in which the tool is running.

The syntax to declare a handle is as follows:

```
handle variable_name ;
```

where *variable_name* is a valid identifier. Handles shall always be initialized to the value `null`, which has a value of 0 on the C side. Handles are very restricted in their usage, with the only legal uses being as follows:

- Only the following operators are valid on `handle` variables:
 - Equality (`==`), inequality (`!=`) with another `handle` or with `null`
 - Case equality (`===`), case inequality (`!==`) with another `handle` or with `null` (same semantics as `==` and `!=`)
- Can be tested for a boolean value that shall be 0 if the `handle` is `null` and 1 otherwise
- Only the following assignments can be made to a `handle`
 - Assignment from another `handle`
 - Assignment to `null`
- Handles can be inserted into associative arrays (refer to Section 4.9), but the relative ordering of any two entries in such an associative array can vary, even between successive runs of the same tool.
- Handles can be used within a class
- Handles can be passed as arguments to functions or tasks
- Handles can be returned from functions

The use of handles is restricted as follows:

- Ports shall not have the `handle` data type
- Handles shall not be assigned to variables of any other type
- Handles shall not be used:
 - In any expression other than as permitted above
 - As ports
 - In sensitivity lists or event expressions

¹ The real and shortreal types are represented as described by IEEE 734-1985, an IEEE standard for floating point numbers.

- In continuous assignments
- In unions
- In packed types

3.7 String data type

SystemVerilog includes a **string** data type, which is a variable size, dynamically allocated array of **characters bytes**. SystemVerilog also includes a number of special methods to work with strings. LRM 279

Verilog supports string literals, but only at the lexical level. In Verilog, string literals behave like packed arrays of a width that is a multiple of 8 bits. A string literal assigned to a packed array **is of an integral variable of a different size is either truncated to the size of the array variable or padded with zeroes to the left as necessary.** LRM 213
LRM 279

In SystemVerilog string literals behave exactly the same as in Verilog. However, SystemVerilog also supports the **string** data type to which a string literal can be assigned. When using the **string** data type instead of **a packed array an integral variable**, strings can be of arbitrary length and no truncation occurs. Literal strings are implicitly converted to the **string** type when assigned to a **string** type or used in an expression involving **string** type operands. LRM 279

Variables of type **string** can be indexed from 0 to N-1 (the last element of the array), and they can take on the special value "", which is the empty string. **Reading an element of a string yields a byte.** LRM 213

The syntax to declare a **string** is:

```
string variable_name [= initial_value];
```

where *variable_name* is a valid identifier and the optional *initial_value* can be a string literal or the value "" for an empty string. For example:

```
string myName = "John Smith";
```

If an initial value is not specified in the declaration, the variable is initialized to "", the empty string.

SystemVerilog provides a set of operators that can be used to manipulate combinations of string variables and string literals. The basic operators defined on the **string string** data type are listed in Table 3-2, **which follows.** LRM 213
LRM 279

A string literal can be assigned to a **string, a character, or a packed array or an integral type**. If their size differs the literal is right justified and **either truncated on the left or zero filled on the left, as necessary.** For example:

```
byte c = "A";           // assign to c "A"
bit [10:0] a = "\x41"; // assigns to a `b000_0100_0001
bit [1:4][7:0] h = "hello" ; // assigns to h "ello"
```

A **string**, string literal, or packed array can be assigned to a **string** variable. The **string** variable shall grow **or shrink** to accommodate the packed array. If the size (in bits) of the packed array is not a multiple of 8, then the packed array is zero filled on the left. LRM 213

For example:

```
string s1 = "hello";    // sets s1 to "hello"
bit [11:0] b = 12'ha41;
string s2 = b;         // sets s2 to 'h0a41
```

As a second example:

```

reg [15:0] r;
integer i = 1;
string b = "";
string a = {"Hi", b};

r = a;           // OK
b = r;           // OK (implicit cast, implementations can issue a warning)
b = "Hi";       // OK
b = {5{"Hi"}};  // OK
a = {i{"Hi"}};  // OK (non constant replication)
r = {i{"Hi"}};  // invalid (non constant replication)
a = {i{b}};     // OK
a = {a,b};      // OK
a = {"Hi",b};   // OK
r = {"H",""};   // yields "H\0" "" is converted to 8'b0
b = {"H",""};   // yields "H" "" is the empty string
a[0] = "h";     // OK same as a[0] = "hi" )

```

LRM 279

Table 3-2: String operators

Operator	Semantics
<code>Str1 == Str2</code>	Equality. Checks if the two strings are equal. Result is 1 if they are equal and 0 if they are not. Both strings can be of type string . Or one of them can be a string literal. If both operands are string literals, the expression is the same Verilog equality operator for integer types. The special value " " is allowed.
<code>Str1 != Str2</code>	Inequality. Logical Negation of ==
<code>Str1 < Str2</code> <code>Str1 <= Str2</code> <code>Str1 > Str2</code> <code>Str1 >= Str2</code>	Comparison. Relational operators return 1 if the corresponding condition is true using the lexicographical ordering of the two strings <code>Str1</code> and <code>Str2</code> . The comparison behaves like the ANSI C <code>strcmp</code> function (or the <code>compare</code> string method) (with regard to the lexical ordering) and embedded null bytes are included. Both operands can be of type string , or one of them can be a string literal.
<code>{Str1, Str2, ..., Strn}</code>	Concatenation. Each operand can be of type string or a string literal (it shall be implicitly converted to type string). If at least one operand is of type string , then the expression evaluates to the concatenated string and is of type string . If all the operands are string literals, then the expression behaves like a Verilog concatenation of integral types; if the result is then used in an expression involving string types, it is implicitly converted to the string type.
<code>{multiplier{Str}}</code>	Replication. <code>Str</code> can be of type string or a string literal. Multiplier must be of integral type and can be non-constant. If multiplier is non-constant or <code>Str</code> is of type string , the result is a string containing N concatenated copies of <code>Str</code> , where N is specified by the multiplier. If <code>Str</code> is a literal and the multiplier is constant, the expression behaves like numeric replication in Verilog (if the result is used in another expression involving string types, it is implicitly converted to the string type).
<code>Str[index]</code>	Indexing. Returns a byte, the ASCII code at the given index. Indexes range from 0 to N-1, where N is the number of characters in the string. If given an index out of range, returns 0. Semantically equivalent to <code>Str.getc(index)</code> , in Section 3.7.3.
<code>Str.method(...)</code>	The dot (.) operator is used to invoke a specified method on strings.

LRM 279

LRM 213

SystemVerilog also includes a number of special methods to work with strings. These methods use the built-in method notation. These methods are described in the following subsections.

3.7.1 len()

```
function int len()
```

- `str.len()` returns the length of the string, i.e., the number of characters in the string (excluding any terminating character).
- If `str` is "", then `str.len()` returns 0.

3.7.2 putc()

```
task putc(int i, string s)  
task putc(int i, byte c)
```

- `str.putc(i, c)` replaces the *i*th character in `str` with the given integral value.
- `str.putc(i, s)` replaces the *i*th character in `str` with the first character in `s`.
- `s` can be any expression that can be assigned to a string.
- `putc` does not change the size of `str`: If $i < 0$ or $i \geq \text{str.len}()$, then `str` is unchanged.

Note: `str.putc(j, x)` is **identical semantically equivalent** to `str[j] = x`.

LRM 237

3.7.3 getc()

```
function int getc(int i)
```

- `str.getc(i)` returns the ASCII code of the *i*th character in `str`.
- If $i < 0$ or $i \geq \text{str.len}()$, then `str.getc(i)` returns 0.

Note: `x = str.getc(j)` is **identical semantically equivalent** to `x = str[j]`.

LRM 237

3.7.4 toupper()

```
function string toupper()
```

- `str.toupper()` returns a string with characters in `str` converted to uppercase.
- `str` is unchanged.

3.7.5 tolower()

```
function string tolower()
```

- `str.toLowerCase()` returns a string with characters in `str` converted to lowercase.
- `str` is unchanged.

3.7.6 compare()

```
function int compare(string s)
```

- `str.compare(s)` compares `str` and `s`, as in the ANSI C `strcmp` function (with regard to lexical ordering and return value), **with a compatible return value** and embedded null bytes are included.

LRM 279

See the relational string operators in Section 3.7, Table 3-2.

3.7.7 icompare()

```
function int icompare(string s)
```

- `str.icompare(s)` compares `str` and `s`, like the ANSI C `strcmp` function (with regard to lexical ordering and return value), with a compatible return value, but the comparison is case insensitive and embedded null bytes are included. LRM 279

3.7.8 substr()

```
function string substr(int i, int j)
```

- `str.substr(i, j)` returns a new string that is a sub-string formed by characters in position `i` through `j` of `str`.
- If `i < 0`, `j < i`, or `j >= str.len()`, `substr()` returns "" (the empty string).

3.7.9 atoi(), atohex(), atoact(), atobin()

```
function integer atoi()
function integer atohex()
function integer atoact()
function integer atobin()
```

- `str.atoi()` returns the integer corresponding to the ASCII decimal representation in `str`. For example:

```
str = "123";
int i = str.atoi(); // assigns 123 to i.
```

The string is converted until the first non-digit is encountered. The conversion scans all leading digits and underscore characters (`_`) and stops as soon as it encounters any other character, or the end of the string. Returns zero if no digits were encountered. It does not parse the full syntax for integer literals (sign, size, tick, base). LRM 213

- `atohex` interprets the string as hexadecimal.
- `atoact` interprets the string as octal.
- `atobin` interprets the string as binary.

3.7.10 atoreal()

```
function real atoreal()
```

- `str.atoreal()` returns the real number corresponding to the ASCII decimal representation in `str`.

The conversion parses Verilog syntax for real constants. The scan stops as soon as it encounters any character that does not conform to this syntax, or the end of the string. Returns zero if no digits were encountered. LRM 213

3.7.11 itoa()

```
task itoa(integer i)
```

- `str.itoa(i)` stores the ASCII decimal representation of `i` into `str` (inverse of `atoi`).

3.7.12 hextoa()

```
task hextoa(integer i)
```

- `str.hextoa(i)` stores the ASCII hexadecimal representation of `i` into `str` (inverse of `atohex`).

3.7.13 octtoa()

```
task octtoa(integer i)
```

- `str.octtoa(i)` stores the ASCII octal representation of `i` into `str` (inverse of `atoact`).

3.7.14 bintoa()

```
task bintoa(integer i)
```

— `str.bintoa(i)` stores the ASCII binary representation of `i` into `str` (inverse of `atobin`).

3.7.15 realtoa()

```
task realtoa(real r)
```

— `str.realtoa(r)` stores the ASCII real representation of `r` into `str` (inverse of `atoreal`).

3.8 Event data type

The **event** data type is an enhancement over Verilog named events. SystemVerilog events provide a handle to a synchronization object. Like Verilog, event variables can be explicitly triggered and waited for. Furthermore, SystemVerilog events have a persistent triggered state that lasts for the duration of the entire time step. In addition, an event variable can be assigned another event variable or the special value `null`. When assigned another event variable, both event variables refer to the same synchronization object. When assigned `null`, the association between the synchronization object and the event variable is broken. Events can be passed as arguments to tasks.

The syntax to declare an **event** is:

```
event variable_name [= initial_value];
```

Where *variable_name* is a valid identifier and the optional *initial_value* can be another event variable or the special value `null`.

If an initial value is not specified then the variable is initialized to a new synchronization object.

If the event is assigned `null`, the event becomes nonblocking, as if it were permanently triggered.

Examples:

```
event done;                // declare a new event called done
event done_too = done;    // declare done_too as alias to done
event empty = null;      // event variable with no synchronization object
```

Event operations and semantics are discussed in detail in Section 13.5.

3.9 User-defined types

<pre>type_declaration ::= typedef data_type type_identifier variable_dimension ; typedef interface_instance_identifier . type_identifier type_identifier ; typedef [enum struct union class] type_identifier ;</pre>	<i>// from Annex A.2.1.3</i>
---	------------------------------

LRM 89

Syntax 3-2—user-defined types (excerpt from Annex A)

The user can define a new type using **typedef**, as in C.

```
typedef int intP;
```

This can then be instantiated as:

```
intP a, b;
```

A type can be used before it is defined, provided it is first identified as a type by an empty **typedef**:

```
typedef foo;
foo f = 1;
typedef int foo;
```

Note that this does not apply to enumeration values, which must be defined before they are used.

User defined type identifiers have the same scoping rules as data identifiers, except that hierarchical reference to type identifiers shall not be allowed. References to type identifiers defined within an **interface** through ports are allowed provided they are locally re-defined before being used.

LRM 213

```
interface intf_i;
    typedef int data_t;
endinterface

module sub(intf_i i p)
    typedef p.data_t my_data_t;
    my_data_t data;
    // type of 'data' will be int when connected to interface above
endmodule
```

User-defined type names must be used for complex data types in casting (see Section 3.14, below), which only allows simple type names, and as type parameter values when unpacked array types are used.

Sometimes a user defined type needs to be declared before the contents of the type has been defined. This is of use with user defined types derived from **enum**, **struct**, **union**, and **class**. For an example, see Section 11.24. Support for this is provided by the following forms for **typedef**:

```
typedef enum type_declaration_identifier;
typedef struct type_declaration_identifier;
typedef union type_declaration_identifier;
typedef class type_declaration_identifier;
typedef type_declaration_identifier;
```

Note that, while this is useful for coupled definitions of classes as shown in Section 11.24, it cannot be used for coupled definitions of structures, since structures are statically declared and there is no support for pointers to structures.

The last form shows that the type of the user defined type does not have to be defined in the forward declaration.

A **typedef** inside a **generate** shall not define the actual type of a forward definition that exists outside the scope of the forward definition.

3.10 Enumerations

```

data_type_common_item data_type ::=                                // from Annex A.2.2.1
    ...
    | enum [ enum_base_type ] { enum_name_declaration { , enum_name_declaration } }
enum_base_type ::=
    integer_atom_type [ signing ]
    | integer_vector_type [ signing ] [ packed_dimension ]
    | type_identifier [ packed_dimension ]25
enum_name_declaration ::=
    enum_identifier [ [ integral_number [ : integral_number ] ] ] [ = constant_expression ]

```

LRM 249

LRM 45

LRM 125

LRM 213

LRM 147

Syntax 3-3—enumerated types (excerpt from Annex A)

An enumerated type declares a set of integral named constants. Enumerated data types provide the capability to abstractly declare strongly typed variables without either a data type or data value(s) and later add the required data type and value(s) for designs that require more definition. Enumerated data types also can be easily referenced or displayed using the enumerated names as opposed to the enumerated values.

In the absence of a data type declaration, the default data type shall be `int`. Any other data type used with enumerated types shall require an explicit data type declaration.

An enumerated type defines a set of named values. In the following example, `light1` and `light2` are defined to be variables of the anonymous (unnamed) enumerated `int` type that includes the three members: `red`, `yellow` and `green`.

```
enum {red, yellow, green} light1, light2; // anonymous int type
```

An enumerated name with x or z assignments assigned to an `enum` with no explicit data type or an explicit 2-state declaration shall be a syntax error.

```
// Syntax error: IDLE=2'b00, XX=2'bx <ERROR>, S1=2'b01??, S2=2'b10??
enum {IDLE, XX='x, S1=2'b01, S2=2'b10} state, next;
```

LRM 213

An `enum` declaration of a 4-state type, such as `integer`, that includes one or more names with x or z assignments shall be permitted.

```
// Correct: IDLE=0, XX='x, S1=1, S2=2
enum integer {IDLE, XX='x, S1='b01, S2='b10} state, next;
```

An unassigned enumerated name that follows an `enum` name with x or z assignments shall be a syntax error.

```
// Syntax error: IDLE=2'b00, XX=2'bx, S1=??, S2=??
enum integer {IDLE, XX='x, S1, S2} state, next;
```

The values can be cast to integer types, and increment from an initial value of 0. This can be overridden.

```
enum {bronze=3, silver, gold} medal; // silver=4, gold=5
```

The values can be set for some of the names and not set for other names. The optional value of an `enum` named constant is an elaboration time constant expression (see Section 5.3) and can include references to parameters, local parameters, `genvars`, other `enum` named constants, and constant functions of these. Hierarchical names and `const` variables are not allowed. A name without a value is automatically assigned an increment of the value of the previous name.

LRM 80
LRM 185

```
// c is automatically assigned the increment-value of 8
enum {a=3, b=7, c} alphabet;
```

If an automatically incremented value is assigned elsewhere in the same enumeration, this shall be a syntax error.

```
// Syntax error: c and d are both assigned 8
enum {a=0, b=7, c, d=8} alphabet;
```

If the first name is not assigned a value, it is given the initial value of 0.

```
// a=0, b=7, c=8
enum {a, b=7, c} alphabet;
```

Any enumeration encoding value that is outside the representable range of the enum shall be an error. If any of the enum members are defined with a different sized constant, this shall be a syntax error.

LRM 171

```
// Correct declaration - bronze and gold are unsized
enum bit [3:0] {bronze='h3, silver, gold='h5} medal4;

// Correct declaration - bronze and gold sizes are redundant
enum bit [3:0] {bronze=4'h3, silver, gold=4'h5} medal4;

// Error in the bronze and gold member declarations
enum bit [3:0] {bronze=5'h13, silver, gold=3'h5} medal4;

// Error in c declaration, requires at least 2 bits
enum bit [0:0] {a,b,c} alphabet;
```

LRM 171

Type checking of enumerated types used in assignments, as arguments and with operators is covered in Section 3.10.3. Like C, there is no overloading of literals, so medal and medal4 cannot be defined in the same scope, since they contain the same names.

3.10.1 Defining new data types as enumerated types

A type name can be given so that the same type can be used in many places.

```
typedef enum {NO, YES} boolean;
boolean myvar; // named type
```

3.10.2 Enumerated type ranges

A range of enumeration elements can be specified automatically, via the following syntax:

Table 3-3: Enumeration element ranges

name	Associates the next consecutive number with name.
name = C	Associates the constant C to name
name [N]	Generates N labels named constants in the sequence: name0, name1, ..., nameN-1. N must be an integral constant
name[N] = C	Optionally, a constant can be assigned to the generated named constants to associate that constant to the first generated named constant; subsequent generated named constants are associated consecutive values. N must be an integral literal constant.
name [N:M]	Creates a sequence of named constants starting with nameN and incrementing or decrementing until reaching named constant nameM.

LRM 82

LRM 185

LRM 213

Table 3-3: Enumeration element ranges

name[N:M] = C	Optionally, a constant can be assigned to the generated named constants to associate that constant to the first generated named constants; subsequent generated named constants are associated consecutive values. N and M must be integral literal constants.
---------------	---

For example:

```
typedef enum { add=10, sub[5], jmp[6:8] } E1;
```

LRM 82

This example defines the enumerated type E1, which assigns the number 10 to the enumerated named constant add. It also creates the enumerated named constants sub0,sub1,sub2,sub3,and sub4, and assigns them the values 11...15, respectively. Finally, the example creates the enumerated named constants jmp6,jmp7, and jmp8, and assigns them the values 16-18, respectively.

LRM 185

```
enum { register[±2] = 1, register[2:4] = 10 } vr;
```

LRM 213

The example above declares enumerated variable vr, which creates the enumerated named constants register0 and register1, which are assigned the values 1 and 2, respectively. Next, it creates the enumerated named constants register2, register3, and register4, and assigns them the values 10, 11, and 12.

LRM 185

3.10.3 Type checking

SystemVerilog enumerated types are strongly typed, thus, a variable of type `enum` cannot be directly assigned a value that lies outside the enumeration set unless an explicit cast is used, or unless the enum variable is a member of a union. This is a powerful type-checking aid that prevents users from accidentally assigning non-existent values to variables of an enumerate type. This restriction only applies to an enumeration that is explicitly declared as a type. The enumeration values can still be used as constants in expressions, and the results can be assigned to any variable of a compatible integral type.

LRM 25

Both the enumeration names and their integer values must be unique. The values can be set to any integral constant value, or auto-incremented from an initial value of 0. It is an error to set two values to the same name, or to set a value to the same auto-incremented value.

Enumerated variables are type-checked in assignments, arguments, and relational operators. Enumerated variables are auto-cast into integral values, but, assignment of arbitrary expressions to an enumerated variable requires an explicit cast.

For example:

```
typedef enum { red, green, blue, yellow, white, black } Colors;
```

This operation assigns a unique number to each of the color identifiers, and creates the new data type Colors. This type can then be used to create variables of that type.

```
Colors c;
c = green;
c = 1;           // Invalid assignment
if ( 1 == c )   // OK. c is auto-cast to integer
```

In the example above, the value `green` is assigned to the variable `c` of type `Colors`. The second assignment is invalid because of the strict typing rules enforced by enumerated types.

Casting can be used to perform an assignment of a different data type, or an out of range value, to an enumerated type. Casting is discussed in Sections 3.10.4, 3.14 and 3.15.

LRM 25

~~3.10.4 Enumerated types in comparison expressions~~

LRM 213

The result of any operation on an enumeration variable after the variable has been assigned an out of range value shall be undefined.

3.10.4 Enumerated types in numerical expressions

Elements of enumerated type variables can be used in numerical expressions. The value used in the expression is the numerical value associated with the enumerated value. For example:

```
typedef enum { red, green, blue, yellow, white, black } Colors;

Colors col;
integer a, b;

a = blue * 3;
col = yellow;
b = col + green;
```

From the previous declaration, blue has the numerical value 2. This example assigns a the value of 6 (2*3): ~~Next~~, and it assigns b a value of 4 (3+1).

LRM 213

An enum variable or identifier used as part of an expression is automatically cast to the base type of the **enum** declaration (either explicitly or using int as the default). An assignment to an enum variable from an expression other than ~~an enum variable or identifier of~~ the same type shall require a cast. Casting to an **enum** type shall cause a conversion of the expression to its base type without checking the validity of the value (unless a dynamic cast is used as described in Section 3.15).

LRM 213

```
typedef enum {Red, Green, Blue} Colors;
typedef enum {Mo,Tu,We,Th,Fr,Sa,Su} Week;
Colors C;
Week W;
int I;

C = Colors'(C+1);           // C is converted to an integer, then added to
                           // one, then converted back to a Colors type

C = C + 1; C++; C+=2; C = I; // Illegal because they would all be
                           // assignments of expressions without a cast

C = Colors'(Su);           // Legal; puts an out of range value into C

I = C + W;                 // Legal; C and W are automatically cast to int
```

SystemVerilog includes a set of specialized methods to enable iterating over the values of enumerated types.

3.10.4.1 first()

The prototype for the `first()` method is:

```
function enum first();
```

The `first()` method returns the value of the first member of the enumeration-~~enum~~.

LRM 213

3.10.4.2 last()

The prototype for the `last()` method is:

```
function enum last();
```

The `last()` method returns the value of the last member of the enumeration-~~enum~~.

LRM 213

3.10.4.3 next()

The prototype for the `next()` method is:

```
function enum next( int unsigned N = 1 );
```

The `next()` method returns the Nth next enumeration value (default is the next one) starting from the current value of the given variable. A wrap to the start of the enumeration occurs when the end of the enumeration is reached. If the given value is not a member of the enumeration, the `next()` method returns the first member.

3.10.4.4 prev()

The prototype for the `prev()` method is:

```
function enum prev( int unsigned N = 1 );
```

The `prev()` method returns the Nth previous enumeration value (default is the previous one) starting from the current value of the given variable. A wrap to the end of the enumeration occurs when the start of the enumeration is reached. If the given value is not a member of the enumeration, the `prev()` method returns the last member.

3.10.4.5 num()

The prototype for the `num()` method is:

```
function int num();
```

The `num()` method returns the number of elements in the given enumeration.

3.10.4.6 name()

The prototype for the `name()` method is:

```
function string name();
```

The `name()` method returns the string representation of the given enumeration value. If the given value is not a member of the enumeration, the `name()` method returns the empty string.

3.10.4.7 Using enumerated type methods

The following code fragment shows how to display the name and value of all the members of an enumeration.

```
typedef enum { red, green, blue, yellow } Colors;
Colors c = c.first;
forever begin
    $display( "%s : %d\n", c.name, c );
    if( c == c.last ) break;
    c = c.next;
end
```

3.11 Structures and unions

```

data_type ::= //from Annex A.2.2.1
    ...
    | struct_union [ packed [ signing ] ] { struct_union_member { struct_union_member } }
        { packed_dimension }14
struct_union_member28 ::=
    { attribute_instance } data_type { packed_dimension }
    data_type_or_void list_of_variable_identifiers ;
    { attribute_instance } void list_of_variable_identifiers ;
data_type_or_void ::= data_type | void
struct_union ::= struct | union [ tagged ]

```

LRM 45
LRM 59

LRM 246

LRM 35

LRM 122

Syntax 3-4—Structures and unions (excerpt from Annex A)

Structure and union declarations follow the C syntax, but without the optional structure tags before the ‘{‘.

```

struct { bit [7:0] opcode; bit [23:0] addr; } IR; // anonymous structure
//defines variable IR
IR.opcode = 1; // set field in IR.

```

Some additional examples of declaring structure and unions are:

```

typedef struct {
    bit [7:0] opcode;
    bit [23:0] addr;
} instruction; // named structure type
instruction IR; // define variable

typedef union { int i; shortreal f; } num; // named union type
num n;
n.f = 0.0; // set n in floating point format

typedef struct {
    bit isfloat;
    union { int i; shortreal f; } n; // anonymous type
} tagged_st; // named structure

tagged_st a[9:0]; // array of structures

```

LRM 213

LRM 162

A structure can be assigned as a whole, and passed to or from a function or task as a whole.

Section 2.8 discusses assigning initial values to a structure.

A packed structure consists of bit fields, which are packed together in memory without gaps. This means that they are easily converted to and from bit vectors. An unpacked structure has an implementation-dependent packing, normally matching the C compiler.

Like a packed array, a packed structure can be used as a whole with arithmetic and logical operators. The first member specified is the most significant and subsequent members follow in decreasing significance. The structures are declared using the **packed** keyword, which can be followed by the **signed** or **unsigned** keywords, according to the desired arithmetic behavior. The default is unsigned:

```

struct packed signed {

```

```

    int a;
    shortint b;
    byte c;
    bit [7:0] d;
} pack1; // signed, 2-state

struct packed unsigned {
    time a;
    integer b;
    logic [31:0] c;
} pack2; // unsigned, 4-state

```

If any data type within a packed structure is 4-state, the whole structure is treated as 4-state. Any 2-state members are converted as if cast. One or more bits of a packed structure can be selected as if it were a packed array, assuming an [n-1:0] numbering:

LRM 162

```
pack1 [15:8] // c
```

Non-integer data types, such as **real** and **shortreal**, are not allowed in packed structures or unions. Nor are unpacked arrays.

A packed structure can be used with a **typedef**.

```

typedef struct packed { // default unsigned
    bit [3:0] GFC;
    bit [7:0] VPI;
    bit [11:0] VCI;
    bit CLP;
    bit [3:0] PT ;
    bit [7:0] HEC;
    bit [47:0] [7:0] Payload;
    bit [2:0] filler;
} s_atmcell;

```

A packed union shall contain members that must be packed structures, or packed arrays or integer data types all of the same size (in contrast to an unpacked union, where the members can be different sizes). This ensures that you can read back a union member that was written as another member. A packed union can also be used as a whole with arithmetic and logical operators, and its behavior is determined by the signed or unsigned keyword, the latter being the default. If a packed union contains a 2-state member and a 4-state member, the entire union is 4 state. There is an implicit conversion from 4-state to 2-state when reading and from 2-state to 4-state when writing the 2-state **bit** member.

LRM 213

For example, a union can be accessible with different access widths:

```

typedef union packed { // default unsigned
    s_atmcell acell;
    bit [423:0] bit_slice;
    bit [52:0] [7:0] byte_slice;
} u_atmcell;

u_atmcell u1;
byte b; bit [3:0] nib;
b = u1.bit_slice[415:408]; // same as b = u1.byte_slice[51];
nib = u1.bit_slice [423:420]; // same as nib = u1.acell.GFC;

```

Note that writing one member and reading another is independent of the byte ordering of the machine, unlike a normal union of normal structures, which are C-compatible and have members in ascending address order.

The signing of unpacked structures is not allowed. The following declaration would be considered illegal:

LRM 78

```

typedef struct signed {
    int f1 ;
    logic f2 ;
} sIllegalSignedUnpackedStructType; // illegal declaration

```

LRM 122

The qualifier **tagged** in a union declares it as a tagged union, which is a type-checked union. An ordinary (untagged) union can be updated using a value of one member type and read as a value of another member type, which is a potential type loophole. A tagged union stores both the member value and a tag, i.e., additional bits representing the current member name. The tag and value can only be updated together consistently, using a statically type-checked tagged union expression (Section 7.15). The member value can only be read with a type that is consistent with the current tag value (i.e., member name). Thus, it is impossible to store a value of one type and (mis)interpret the bits as another type.

In addition to type safety, the use of member names as tags also makes code simpler and smaller than code that has to track unions with explicit tags. Tagged unions can also be used with pattern matching (Section 8.4), which improves readability even further.

In tagged unions, members can be declared with type **void**, when all the information is in the tag itself, as in the following example of an integer together with a valid bit:

```

typedef union tagged {
    void Invalid;
    int Valid;
} VInt;

```

A value of `VInt` type is either `Invalid` and contains nothing, or is `Valid` and contains an `int`. Section 7.15 describes how to construct values of this type, and also describes how it is impossible to read an integer out of a `VInt` value that currently has the `Invalid` tag.

Example:

```

typedef union tagged {
    struct {
        bit [4:0] reg1, reg2, regd;
    } Add;
    union tagged {
        bit [9:0] JumpU;
        struct {
            bit [1:0] cc,
            bit [9:0] addr;
        } JumpC;
    } Jump;
} Instr;

```

A value of `Instr` type is either an `Add` instruction, in which case it contains three 5-bit register fields, or it is a `Jump` instruction. In the latter case, it is either an unconditional jump, in which case it contains a 10-bit destination address, or it is a conditional jump, in which case it contains a 2-bit condition-code register field and a 10-bit destination address. Section 7.15 describes how to construct values of `Instr` type, and describes how, in order to read the `cc` field, for example, the instruction must have opcode `Jump` and sub-opcode `JumpC`.

When the **packed** qualifier is used on a tagged union, all the members must have packed types, but they do not have to be of the same size. The (standard) representation for a packed tagged union is the following.

- The size is always equal to the number of bits needed to represent the tag plus the maximum of the sizes of the members.
- The size of the tag is the minimum number of bits needed to code for all the member names (e.g., 5 to 8 members would need 3 tag bits).

- The tag bits are always left-justified (i.e., towards the most-significant bits).
- For each member, the member bits are always right-justified (i.e., towards the least significant bits).
- The bits between the tag bits and the member bits are undefined. In the extreme case of a void member, only the tag is significant and all the remaining bits are undefined.

The representation scheme is applied recursively to any nested tagged unions.

Example: If the `VInt` type definition had the `packed` qualifier, `Invalid` and `Valid` values will have the following layouts, respectively:

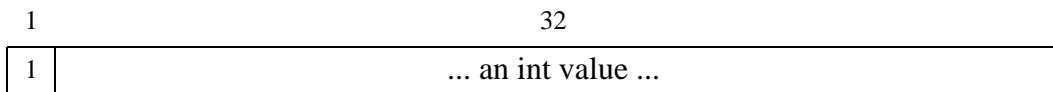
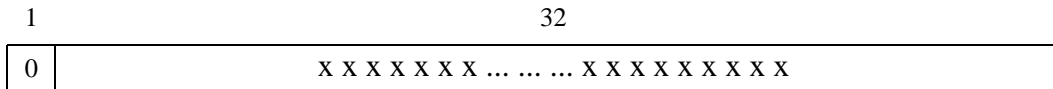

tag is 0 for Invalid, 1 for Valid

Example: If the `Instr` type had the `packed` qualifier, its values will have the following layouts:

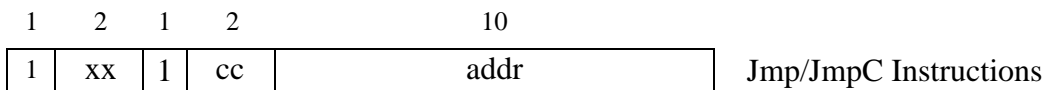
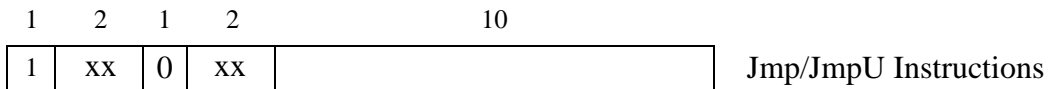

tag is 0 for Add, 1 for Jmp
Outer tag is 0 for Add, 1 for Jmp
Inner tag is 0 for JmpU, 1 for JmpC

LRM 213

3.12 Class

A *class* is a collection of data and a set of subroutines that operate on that data. The data in a class **is** are referred to as class properties, and its subroutines are called methods. The class properties and methods, taken together, define the contents and capabilities of a class instance or object.

LRM 213

LRM 48

```

class_declaration ::=                                     //from Annex A.1.3
  [ virtual ] class [ lifetime ] class_identifier [ parameter_port_list ]
  [ extends class_identifier [ parameter_value_assignment ] [ ( list_of_arguments ) ] ;]
  [ extends class_type [ ( list_of_arguments ) ] ];
  { class_item }
  endclass [ : class_identifier]

```

LRM 34

LRM 174

LRM 216
LRM 249

Syntax 3-5—Classes (excerpt from Annex A)

The object-oriented class extension allows objects to be created and destroyed dynamically. Class instances, or objects, can be passed around via object handles, which add a safe-pointer capability to the language. An object can be declared as an argument with direction **input**, **output**, **inout**, or **ref**. In each case, the argument copied is the object handle, not the contents of the object.

LRM 48

A Class is declared using the **class...endclass** keywords. For example:

```

class Packet;
  int address;           // Properties are address, data, and crc
  bit [63:0] data;
  shortint crc;
  Packet next;         // Handle to another Packet

  function new();      // Methods are send and new
  function bit send();
endclass : Packet

```

LRM 213

Any data type can be declared as a class member. Classes are discussed in more detail in Section 11.

3.13 Singular and aggregate types

LRM 103

Data types are categorized as either *singular* or *aggregate*. A singular type shall be any data type except an unpacked structure, union, or array (see Section 4 on arrays). An aggregate type shall be any unpacked structure, union, or array data type. A singular variable or expression represents a single value, symbols, or handle. Aggregate expressions and variables represent a set or collection of singular values. Integral types are always singular even though they can be sliced into multiple singular values.

These categories are defined so that operators and functions can simply refer to these data types as a collective group. For example, some functions recursively descend into an aggregate variable until reaching a singular value, and then perform an operation on each singular value.

Note that although a class is a type, there are no variables or expressions of class type directly, only class object handles which are singular. So classes need not be categorized in this manner (see Section 11 on classes).

3.14 Casting

```

constant_cast ::= // from Annex A.8.4
    casting_type ' ( constant_expression )
    | casting_type ' constant_concatenation
    | casting_type ' constant_multiple_concatenation
cast ::=
    casting_type ' ( expression )
    | casting_type ' concatenation
    | casting_type ' multiple_concatenation
casting_type ::= simple_type | size | signing // from Annex A.2.2.1
simple_type ::= integer_type | non_integer_type | ps_type_identifier
    
```

LRM 160

LRM 249

Syntax 3-6—casting (excerpt from Annex A)

A data type can be changed by using a cast (') operation. The expression to be cast must be enclosed in **parenthesis parentheses** or within concatenation or replication braces and is self-determined.

LRM 124

LRM 214

```

    int' (2.0 * 3.0)
    shortint' {8'hFA, 8'hCE}
    
```

A positive decimal number as a data type means a number of bits to change the size.

LRM 76

```

    17' (x - 2)
    
```

The signedness can also be changed.

```

    signed' (x)
    
```

A user-defined type can be used.

```

    mytype' (foo)
    
```

The expression inside the cast must be an integral value when changing the size or signing. When changing the size, the signing passes through unchanged. When changing the signing, the size passes through unchanged.

When casting to a predefined type, the prefix of the cast must be the predefined type keyword. When casting to a user-defined type, the prefix of the cast must be the user-defined type identifier.

When a **shortreal** is converted to an **int** or to 32 bits, its value is rounded, as in Verilog. Therefore, the conversion can lose information. To convert a **shortreal** to its underlying bit representation without a loss of information, use \$shortrealtobits as defined in Section 23.6. To convert from the bit representation of a shortreal value into a **shortreal**, use \$bitstoshortreal as defined in Section 23.6.

Structures can be converted to bits preserving the bit pattern, which means they can be converted back to the same value without any loss of information. When unpacked data is converted to the packed representation, the order of the data in the packed representation is such that the first field in the structure occupies the most significant bits. The effect is the same as a concatenation of the data items (struct fields or array elements) in order. The type of the elements in an unpacked structure or array must be valid for a packed representation in order to be cast to any other type, whether packed or unpacked.

LRM 109

An explicit cast between packed types is not required since they are treated as integral values, but a cast can be used by tools to perform stronger type checking.

The following example demonstrates how the \$bits attribute is used to obtain the size of a structure in bits

(the \$bits system function is discussed in Section 23.4), which facilitates conversion of the structure into a packed array:

```

typedef struct {
    bit isfloat;
    union { int i; shortreal f; } n; // anonymous type
} tagged_st; // named structure

typedef bit [$bits(tagged_st) - 1 : 0] tagbits; // tagged_st defined above

tagged_st a [7:0]; // unpacked array of structures

tagbits t = tagbits'(a[3]); // convert structure to array of bits
a[4] = tagged_st'(t); // convert array of bits back to structure

```

LRM 162

LRM 213

Note that the `bit` data type loses X values. If these are to be preserved, the `logic` type should be used instead.

The size of a union in bits is the size of its largest member. The size of a `logic` in bits is 1.

For compatibility, the Verilog functions \$itor, \$rttoi, \$bitstoreal, \$realtobits, \$signed, \$unsigned can also be used.

3.15 \$cast dynamic casting

SystemVerilog provides the \$cast system task to assign values to variables that might not ordinarily be valid because of differing data type. \$cast can be called as either a task or a function.

The syntax for \$cast is:

```
function int $cast( singular dest_var, singular source_exp );
```

or

```
task $cast( singular dest_var, singular source_exp );
```

The *dest_var* is the variable to which the assignment is made.

The *source_exp* is the expression that is to be assigned to the destination variable.

Use of \$cast as either a task or a function determines how invalid assignments are handled.

When called as a task, \$cast attempts to assign the source expression to the destination variable. If the assignment is invalid, a runtime error occurs and the destination variable is left unchanged.

When called as a function, \$cast attempts to assign the source expression to the destination variable, and returns 1 if the cast is legal. If the cast fails, the function does not make the assignment and returns 0. When called as a function, no runtime error occurs, and the destination variable is left unchanged.

It's important to note that \$cast performs a run-time check. No type checking is done by the compiler, except to check that the destination variable and source expression are singulars.

For example:

```

typedef enum { red, green, blue, yellow, white, black } Colors;
Colors col;
$cast( col, 2 + 3 );

```

This example assigns the expression (5 => black) to the enumerated type. Without \$cast, or the static compile-time cast described below, this type of assignment is illegal.

LRM 25

The following example shows how to use the `$cast` to check if an assignment will succeed:

```
if ( ! $cast( col, 2 + 8 ) ) // 10: invalid cast
    $display( "Error in cast" );
```

Alternatively, the preceding examples can be cast using a static SystemVerilog cast operation: For example:

```
col = Colors'( 2 + 3 );
```

However, this is a compile-time cast, i.e, a coercion that always succeeds at run-time, and does not provide for error checking or warn if the expression lies outside the enumeration values.

Allowing both types of casts gives full control to the user. If users know that it is safe to assign certain expressions to an enumerated variable, the faster static compile-time cast can be used. If users need to check if the expression lies within the enumeration values, it is not necessary to write a lengthy switch statement manually, the compiler automatically provides that functionality via the `$cast` function. By allowing both types of casts, users can control the time/safety trade-offs.

Note: `$cast` is similar to the `dynamic_cast` function available in C++, but, `$cast` allows users to check if the operation will succeed, whereas `dynamic_cast` always raises a C++ exception.

3.16 Bit-stream casting

LRM 109

Type casting can also be applied to unpacked arrays and structs. It is thus possible to convert freely between bit-stream types using explicit casts. Types that can be packed into a stream of bits are called bit-stream types. A bit-stream type is a type consisting of the following:

- Any integral, packed, or string type
- Unpacked arrays, structures, or classes of the above types
- Dynamically-sized arrays (dynamic, associative, or queues) of any of the above types

This definition is recursive, so that, for example, a structure containing a queue of `int` is a bit-stream type.

Assuming A is of bit-stream type `source_t` and B is of bit-stream type `dest_t`, it is legal to convert A into B by an explicit cast:

```
B = dest_t'( A );
```

The conversion from A of type `source_t` to B of type `dest_t` proceeds in two steps:

- 1) Conversion from `source_t` to a generic packed value containing the same number of bits as `source_t`. If `source_t` contains any 4-state data, the entire packed value is 4-state; otherwise, it is 2-state.
- 2) Conversion from the generic packed value to `dest_t`. If the generic packed value is a 4-state type and parts of `dest_t` designate 2-state types then those parts in `dest_t` are assigned as if cast to a 2-state.

When a dynamic array, queue, or string is converted to the packed representation, the item at index 0 occupies the most significant bits. When an associative array is converted to the packed representation, items are packed in index-sorted order with the first indexed element occupying the most significant bits.

Both `source_t` and `dest_t` can include one or more dynamically sized data in any position (for example, a structure containing a dynamic array followed by a queue of bytes). If the source type, `source_t`, includes dynamically-sized variables, they are all included in the bit-stream. If the destination type, `dest_t`, includes unbounded dynamically-sized types, the conversion process is greedy: compute the size of the `source_t`, subtract the size of the fixed-size data items in the destination, and then adjust the size of the first dynamically sized item in the destination to the remaining size; any remaining dynamically-sized items are left empty.

For the purposes of a bit-stream cast, a string is considered a dynamic array of bytes.

Regardless of whether the destination type contains only fixed-size items or dynamically-sized items, data is extracted into the destination in left-to-right order. It is thus legal to fill a dynamically-sized item with data extracted from the middle of the packed representation.

If both `source_t` and `dest_t` are fixed sized unpacked types of different sizes then a cast generates a compile-time error. If `source_t` or `dest_t` contain dynamically-sized types then a difference in their sizes will generate an error either at compile time or run time, as soon as it is possible to determine the size mismatch. For example:

```
// Illegal conversion from 24-bit struct to int (32 bits) - compile time error
struct {bit[7:0] a; shortint b;} a;
int b = int'(a);

// Illegal conversion from 20-bit struct to int (32 bits) - run time error
struct {bit a[$]; shortint b;} a = {{1,2,3,4}, 67};
int b = int'(a);

// Illegal conversion from int (32 bits) to struct dest_t (25 or 33 bits),
// compile time error
typedef struct {byte a[$]; bit b;} dest_t;
int a;
dest_t b = dest_t'(a);
```

Bit-stream casting can be used to convert between different aggregate types, such as two structure types, or a structure and an array or queue type. This conversion can be useful to model packet data transmission over serial communication streams. For example, the code below uses bit-stream casting to model a control packet transfer over a data stream:

```
typedef struct {
    shortint address;
    reg [3:0] code;
    byte command [2];
} Control;

typedef bit Bits [36:1];

Control p;
Bits stream[$];

p = ... // initialize control packet
stream = {stream, Bits'(p)} // append packet to unpacked queue of bits

Control q;
q = Control'(stream[0]); // convert stream back to a Control packet
stream = stream[1:$]; // remove packet from stream
```

The following example uses bit-stream casting to model a data packet transfer over a byte stream:

```
typedef struct {
    byte length;
    shortint address;
    byte payload[];
    byte chksum;
} Packet;
```

The above type defines a generic data packet in which the size of the payload field is stored in the length field. Below is a function that randomly initializes the packet and computes the checksum.

```
function Packet genPkt();
```

```
    Packet p;  
  
    void' ( randomize( p.address, p.length, p.payload )  
          with { p.length > 1 && p.payload.size == p.length } );  
    p.chksum = p.payload.xor();  
    return p;  
endfunction
```

The byte stream is modeled using a queue, and a bit-stream cast is used to send the packet over the stream.

```
typedef byte channel_type[$];  
channel_type channel;  
channel = {channel, channel_type'(genPkt())};
```

And the code to receive the packet:

```
Packet p;  
int    size;  
  
size = channel[0] + 4;  
p = Packet'( channel[0 : size - 1] );    // convert stream to Packet  
channel = channel[ size, $ ];           // remove packet data from stream
```

Section 4 Arrays

4.1 Introduction (informative)

An array is a collection of variables, all of the same type, and accessed using the same name plus one or more indices.

In C, arrays are indexed from 0 by integers, or converted to pointers. Although the whole array can be initialized, each element must be read or written separately in procedural statements.

In Verilog-2001, arrays are indexed from left-bound to right-bound. If they are vectors, they can be assigned as a single unit, but not if they are arrays. Verilog-2001 allows multiple dimensions.

In Verilog-2001, all data types can be declared as arrays. The `reg`, `wire` and all other net types can also have a vector width declared. A dimension declared before the object name is referred to as the “vector width” dimension. The dimensions declared after the object name are referred to as the “array” dimensions.

```
reg [7:0] r1 [1:256]; // [7:0] is the vector width, [1:256] is the array size
```

~~SystemVerilog enhances array declarations in several ways. SystemVerilog supports fixed-size arrays, dynamic arrays, and associative arrays. Fixed-size arrays can be multi-dimensional and have fixed storage allocated for all the elements of the array. Dynamic arrays also allocate storage for all the elements of the array, but the array size can be changed dynamically. Dynamic and associative arrays are one-dimensional. Fixed-size and dynamic arrays are indexed using integer expressions, while associative arrays can be indexed using arbitrary data types. Associative arrays do not have any storage allocated until it is needed, which makes them ideal for dealing with sparse data.~~

LRM 203

SystemVerilog uses the term “*packed array*” to refer to the dimensions declared before the object name (what Verilog-2001 refers to as the vector width). The term “*unpacked array*” is used to refer to the dimensions declared after the object name.

```
bit [7:0] c1; // packed array
real u [7:0]; // unpacked array
```

SystemVerilog enhances packed arrays by allowing multiple dimensions. SystemVerilog adds the ability to procedurally change the size of one of the dimensions of an unpacked array. Fixed-size unpacked arrays can be multi-dimensional and have fixed storage allocated for all the elements of the array. Each dimension of an unpacked array can be declared as having a fixed or un-fixed size. A dynamic array allocates storage for elements at runtime along with option of changing the size of one of its dimensions. An associative array allocates storage for elements individually as they are written. Associative arrays can be indexed using arbitrary data types. A queue type of array grows or shrinks to accommodate the number elements written to the array at runtime.

4.2 Packed and unpacked arrays

~~SystemVerilog uses the term “*packed array*” to refer to the dimensions declared before the object name (what Verilog-2001 refers to as the vector width). The term “*unpacked array*” is used to refer to the dimensions declared after the object name.~~

LRM 203

```
bit [7:0] c1; // packed array
real u [7:0]; // unpacked array
```

A packed array is a mechanism for subdividing a vector into subfields which can be conveniently accessed as array elements. Consequently, a packed array is guaranteed to be represented as a contiguous set of bits. An unpacked array may or may not be so represented. A packed array differs from an unpacked array in that, when

a packed array appears as a primary, it is treated as a single vector.

If a packed array is declared as signed, then the array viewed as a single vector shall be signed. **The individual elements of the array are unsigned unless they are of a named type declared as signed.** A part-select of a packed array shall be unsigned. LRM 232

Packed arrays allow arbitrary length integer types, so a 48 bit integer can be made up of 48 bits. These integers can then be used for 48 bit arithmetic. The maximum size of a packed array can be limited, but shall be at least 65536 (2^{16}) bits.

Packed arrays can only be made of the single bit types (**bit**, **logic**, **reg**, **wire**, and the other net types) and recursively other packed arrays and packed structures.

Integer types with predefined widths cannot have packed array dimensions declared. These types are: **byte**, **shortint**, **int**, **longint**, and **integer**. An integer type with a predefined width can be treated as a single dimension packed array. The packed dimensions of these integer types shall be numbered down to 0, such that the right-most index is 0.

```
byte c2;    // same as bit [7:0] c2;
integer i1; // same as logic signed [31:0] i1;
```

Unpacked arrays can be made of any type. SystemVerilog enhances fixed-size unpacked arrays in that in addition to all other variable types, unpacked arrays can also be made of object handles (see Section 11.4) and events (see Section 13.5).

SystemVerilog accepts a single number, as an alternative to a range, to specify the size of an unpacked array, like C. That is, [size] becomes the same as [0:size-1]. For example: LRM 4

```
int Array[8][32]; is the same as: int Array[0:7][0:31];
```

The following operations can be performed on all arrays, packed or unpacked. The examples provided with these rules assume that A and B are arrays of the same shape and type.

- Reading and writing the array, e.g., A = B
- Reading and writing a slice of the array, e.g., A[i:j] = B[i:j]
- Reading and writing a variable slice of the array, e.g., A[x+:c] = B[y+:c]
- Reading and writing an element of the array, e.g., A[i] = B[i]
- Equality operations on the array or slice of the array, e.g. A==B, A[i:j] != B[i:j]

The following operations can be performed on packed arrays, but not on unpacked arrays. The examples provided with these rules assume that A is an array.

- Assignment from an integer, e.g., A = 8'b11111111;
- Treatment as an integer in an expression, e.g., (A + 3)

If an unpacked array is declared as signed, then this applies to the individual elements of the array, since the whole array cannot be viewed as a single vector. LRM 232

When assigning to an unpacked array, the source and target must be arrays with the same number of unpacked dimensions, and the length of each dimension must be the same. Assignment to an unpacked array is done by assigning each element of the source unpacked array to the corresponding element of the target unpacked array. Note that an element of an unpacked array can be a packed array.

For the purposes of assignment, a packed array is treated as a vector. Any vector expression can be assigned to any packed array. The packed array bounds of the target packed array do not affect the assignment. A packed array cannot be directly assigned to an unpacked array without an explicit cast. LRM 109

4.3 Multiple dimensions

Like Verilog memories, the dimensions following the type set the packed size. The dimensions following the instance set the unpacked size.

```
bit [3:0] [7:0] joe [1:10]; // 10 entries of 4 bytes (packed into 32 bits)
```

can be used as follows:

```
joe[9] = joe[8] + 1; // 4 byte add
joe[7][3:2] = joe[6][1:0]; // 2 byte copy
```

Note that the dimensions declared following the type and before the name ([3:0] [7:0] in the preceding declaration) vary more rapidly than the dimensions following the name ([1:10] in the preceding declaration). When used, the first dimensions ([3:0]) follow the second dimensions ([1:10]).

In a list of dimensions, the right-most one varies most rapidly, as in C. However a packed dimension varies more rapidly than an unpacked one.

```
bit [1:10] foo1 [1:5]; // 1 to 10 varies most rapidly; compatible with
                        Verilog-2001 arrays
bit foo2 [1:5] [1:10]; // 1 to 10 varies most rapidly, compatible with C
bit [1:5] [1:10] foo3; // 1 to 10 varies most rapidly
bit [1:5] [1:6] foo4 [1:7] [1:8]; // 1 to 6 varies most rapidly, followed by
                                1 to 5, then 1 to 8 and then 1 to 7
```

Multiple packed dimensions can also be defined in stages with **typedef**.

```
typedef bit [1:5] bsix;
bsix [1:10] foo5; // 1 to 5 varies most rapidly
```

Multiple unpacked dimensions can also be defined in stages with **typedef**.

```
typedef bsix mem_type [0:3]; // array of four 'bsix' elements
mem_type bar [0:7]; // array of eight 'mem_type' elements
```

When the array is used with a smaller number of dimensions, these have to be the slowest varying ones.

```
bit [9:0] foo6;
foo5 = foo1[2]; // a 10 bit quantity.
```

As in Verilog-2001, a comma-separated list of array declarations can be made. All arrays in the list shall have the same data type and the same packed array dimensions.

```
bit [7:0] [31:0] foo7 [1:5] [1:10], foo8 [0:255]; // two arrays declared
```

If an index expression is out of the address bounds or if any bit in the address is X or Z, then the index shall be invalid. The result of reading from an array with an invalid index shall return the default uninitialized value for the array element type. Writing to an array with an invalid index shall perform no operation. Implementations can generate a warning if an invalid index occurs for a read or write operation of an array.

LRM 87

LRM 197

4.4 Indexing and slicing of arrays

An expression can select part of a packed array, or any integer type, which is assumed to be numbered down to 0.

SystemVerilog uses the term “*part select*” to refer to a selection of one or more contiguous bits of a single dimension packed array. This is consistent with the usage of the term “*part select*” in Verilog.

```
reg [63:0] data;
reg [7:0] byte2;
byte2 = data[23:16]; // an 8-bit part select from data
```

LRM 100

SystemVerilog uses the term “*slice*” to refer to a selection of one or more contiguous elements of an array. Verilog only permits a single element of an array to be selected, and does not have a term for this selection.

An single element of a packed or unpacked array can be selected using an indexed name.

```
bit [3:0] [7:0] j; // j is a packed array
byte k;
k = j[2]; // select a single 8-bit element from j
```

One or more contiguous elements can be selected using a slice name. A slice name of a packed array is a packed array. A slice name of an unpacked array is an unpacked array.

```
bit busA [7:0] [31:0] ; // unpacked array of 8 32-bit vectors
int busB [1:0]; // unpacked array of 2 integers
busB = busA[7:6]; // select a slice from busA
```

The size of the part select or slice must be constant, but the position can be variable. The syntax of Verilog-2001 is used.

```
int i = bitvec[j +: k]; // k must be constant.
int a[x:y], b[y:z], e;
a = {b[c -: d], e}; // d must be constant
```

Slices of an array can only apply to one dimension, but other dimensions can have single index values in an expression.

4.5 Array querying functions

SystemVerilog provides new system functions to return information about an array. These are: `$left`, `$right`, `$low`, `$high`, `$increment`, `$size`, and `$dimensions`. These functions are described in Section 23.7.

LRM 111

4.6 Dynamic arrays

~~Dynamic arrays are one dimensional unpacked arrays~~ A dynamic array is one-dimension of an unpacked array whose size can be set or changed at runtime. The space for a dynamic array doesn't exist until the array is explicitly created at runtime.

LRM 103

LRM 203

The syntax to declare a dynamic array is:

```
data_type array_name [];
```

where `data_type` is the data type of the array elements. Dynamic arrays support the same types as fixed-size arrays.

For example:

```
bit [3:0] nibble[]; // Dynamic array of 4-bit vectors
integer mem[]; // Dynamic array of integers
```

The `new []` operator is used to set or change the size of the array.

The `size()` built-in method returns the current size of the array.

The `delete()` built-in method clears all the elements yielding an empty array (zero size).

4.6.1 new[]

The built-in function `new` allocates the storage and initializes the newly allocated array elements either to their default initial value or to the values provided by the optional argument.

The prototype of the `new` function is:

```
array_identifier = new[size] [(src_array)];
```

<pre>blocking_assignment ::= // from Annex A.6.2 ... hierarchical_dynamic_array_variable_identifier [=] = dynamic_array_new ... dynamic_array_new ::= // from Annex A.2.4 new [expression] [(dynamic_array_variable_identifier expression)]</pre>	<div style="border: 1px solid black; padding: 2px; width: fit-content;">LRM 265 LRM268</div>
---	--

Syntax 4-1—Declaration of dynamic array new (excerpt from Annex A)

`size [expression]:`

The number of elements in the array. Must be a non-negative integral expression.

`src_array (expression):`

Optional. The name of an array with which to initialize the new array. If `src_array` it is not specified, the elements of `array_name` the newly allocated array are initialized to their default value. `src_array` This array identifier must be a dynamic array of the same data type as `array_name` the array on the left-hand side, but it need not have the same size. If the size of `src_array` this array is less than `size` the size of the new array, the extra elements of `array_name` shall be initialized to their default value. If the size of `src_array` this array is greater than `size` the size of the new array, the additional elements of `src_array` shall be ignored.

This argument is useful when growing or shrinking an existing array. In this situation, `src_array` the value of `(expression)` is `array_name` the same as the left-hand side, so the previous values of the array elements are preserved. For example:

```
integer addr[]; // Declare the dynamic array.
addr = new[100]; // Create a 100-element array.
...
// Double the array size, preserving previous values.
addr = new[200] (addr);
```

The `new` operator follows the SystemVerilog precedence rules. Since both the square brackets `[]` and the parenthesis `()` have the same precedence, the arguments to this operator are evaluated left to right: `size [expression]` first, and `src_array (expression)` second.

4.6.2 size()

The prototype for the `size()` method is:

```
function int size();
```

The `size()` method returns the current size of a dynamic array, or zero if the array has not been created.

```
int j = addr.size;
addr = new[ addr.size() * 4 ] (addr); // quadruple addr array
```

Note: The size method is equivalent to `$length(addr, 1)`.

4.6.3 delete()

The prototype for the `delete()` method is:

```
function void delete();
```

The `delete()` method empties the array, resulting in a zero-sized array.

```
int ab [] = new[ N ]; // create a temporary array of size N
// use ab
ab.delete; // delete the array contents
$display( "%d", ab.size ); // prints 0
```

4.7 Array assignment

Assigning to a fixed-size unpacked array requires that the source and the target both be arrays with the same number of unpacked dimensions, and the length of each dimension be the same. Assignment is done by assigning each element of the source array to the corresponding element of the target array, which requires that the source and target arrays be of compatible types. Compatible types are types that are assignment compatible. Assigning fixed-size unpacked arrays of unequal size to one another shall result in a type check error.

```
int A[10:1]; // fixed-size array of 10 elements
int B[0:9]; // fixed-size array of 10 elements
int C[24:1]; // fixed-size array of 24 elements

A = B; // ok. Compatible type and same size
A = C; // type check error: different sizes
```

An array of wires can be assigned to an array of variables having the same number of unpacked dimensions and the same length for each of those dimensions, and vice-versa.

```
wire [31:0] W [9:0];
assign W = A;
initial #10 B = W;
```

A dynamic array can be assigned to a one-dimensional fixed-size array of a compatible type, if the size of the dynamic array is the same as the length of the fixed-size array dimension. Unlike assigning with a fixed-size array, this operation requires a run-time check that can result in an error.

```
int A[100:1]; // fixed-size array of 100 elements
int B[] = new[100]; // dynamic array of 100 elements
int C[] = new[8]; // dynamic array of 8 elements

A = B; // OK. Compatible type and same size
A = C; // type check error: different sizes
```

A dynamic array or a one-dimensional fixed-size array can be assigned to a dynamic array of a compatible type. In this case, the assignment creates a new dynamic array with a size equal to the length of the fixed-size array. For example:

```
int A[100:1]; // fixed-size array of 100 elements
int B[]; // empty dynamic array
```

SystemVerilog 3.1a/draft 5

```

int C[] = new[8];           // dynamic array of size 8

B = A;                       // ok. B has 100 elements
B = C;                       // ok. B has 8 elements

```

The last statement above is equivalent to:

```
B = new[ C.size ] (C);
```

Similarly, the source of an assignment can be a complex expression involving array slices or concatenations. For example:

```

string d[1:5] = { "a", "b", "c", "d", "e" };
string p[];
p = { d[1:3], "hello", d[4:5] };

```

The preceding example creates the dynamic array p with contents: “a”, “b”, “c”, “hello”, “d”, “e”.

4.8 Arrays as arguments

Arrays can be passed as arguments to tasks or functions. The rules that govern array argument passing by value are the same as for array assignment (see Section 10.4). When an array argument is passed by value, a copy of the array is passed to the called task or function. This is true for all array types: fixed-size, dynamic, or associative. LRM 190

Note that unsized dimensions can occur in dynamic arrays and in formal arguments of import DPI functions. If one **of** dimensions of a formal is unsized, then any size of the corresponding dimension of an actual is accepted. LRM 198
LRM 265

For example, the declaration:

```
task fun(int a[3:1][3:1]);
```

declares task fun that takes one argument, a two dimensional array with each dimension of size three. A call to fun must pass a two dimensional array and with the same dimension size 3 for all the dimensions. For example, given the above description for fun, consider the following actuals:

```

int b[3:1][3:1];           // OK: same type, dimension, and size

int b[1:3][0:2];          // OK: same type, dimension, & size (different ranges)

reg b[3:1][3:1];          // OK: assignment compatible type LRM 198

event b[3:1][3:1];        // error: incompatible type

int b[3:1];                // error: incompatible number of dimensions

int b[3:1][4:1];          // error: incompatible size (3 vs. 4)

```

A subroutine that accepts a one-dimensional fixed-size array can also be passed a dynamic array of a compatible type of the same size.

For example, the declaration:

```
task bar( string arr[4:1] );
```

declares a task that accepts one argument, an array of 4 strings. This task can accept the following actual arguments:

```

string b[4:1];           // OK: same type and size
string b[5:2];          // OK: same type and size (different range)
string b[] = new[4];    // OK: same type and size, requires run-time check

```

A subroutine that accepts a dynamic array can be passed a dynamic array of a compatible type or a one-dimensional fixed-size array of a compatible type

For example, the declaration:

```

task foo( string arr[] );

```

declares a task that accepts one argument, a dynamic array of 4 strings. This task can accept any one-dimensional array of strings or any dynamic array of strings.

An import DPI function that accepts a one-dimensional array can be passed a dynamic array of a compatible type and of any size if formal is unsized, and of the same size if formal is sized.

LRM 17

4.9 Associative arrays

Dynamic arrays are useful for dealing with contiguous collections of variables whose number changes dynamically. When the size of the collection is unknown or the data space is sparse, an associative array is a better option. Associative arrays do not have any storage allocated until it is used, and the index expression is not restricted to integral expressions, but can be of any type.

An associative array implements a lookup table of the elements of its declared type. The data type to be used as an index serves as the lookup key, and imposes an ordering.

The syntax to declare an associative array is:

```

data_type array_id [ index_type ];

```

where:

- *data_type* is the data type of the array elements. Can be any type allowed for fixed-size arrays.
- *array_id* is the name of the array being declared.
- *index_type* is the data-type to be used as an index, or *. If * is specified, then the array is indexed by any integral expression of arbitrary size. An index type restricts the indexing expressions to a particular type.

Examples of associative array declarations are:

```

integer i_array[*];           // associative array of integer (unspecified
                               // index)

bit [20:0] array_b[string];    // associative array of 21-bit vector, indexed
                               // by string

event ev_array[myClass];      // associative array of event indexed by class
                               // myClass

```

Array elements in associative arrays are allocated dynamically; an entry is created the first time it is written. The associative array maintains the entries that have been assigned values and their relative order according to the index data type. Associative arrays' elements are unpacked, meaning that other than copying or comparing arrays, you must select an individual element out of the array before using it in most expressions.

LRM 103

LRM 265

4.9.1 Wildcard index type

Example: `int array_name [*];`

Associative arrays that specify a wildcard index type have the following properties:

- The array can be indexed by any integral data type. Since the indices can be of different sizes, the same numerical value can have multiple representations, each of a different size. SystemVerilog resolves this ambiguity by detecting the number of leading zeros and computing a unique length and representation for every value.
- Non-integral index types are illegal and result in a type check error.
- A 4-state Index containing X or Z is invalid.
- Indices are unsigned.
- Indexing expressions are self-determined; signed indices are not sign extended.
- A string literal index is auto-cast to a bit-vector of equivalent size.
- The ordering is numerical (smallest to largest).

4.9.2 String index

Example: `int array_name [string];`

Associative arrays that specify a string index have the following properties:

- Indices can be strings or string literals of any length. Other types are illegal and shall result in a type check error.
- An empty string “” index is valid.
- The ordering is lexicographical (lesser to greater).

4.9.3 Class index

Example: `int array_name [some_Class];`

Associative arrays that specify a class index have the following properties:

- Indices can be objects of that particular type or derived from that type. Any other type is illegal and shall result in a type check error.
- A null index is valid.
- The ordering is deterministic but arbitrary.

4.9.4 Integer (or int) index

Example: `int array_name [integer];`

Associative arrays that specify an integer index have the following properties:

- Indices can be any integral expression.
- Indices are signed.
- A 4-state index containing X or Z is invalid.
- Indices smaller than integer are sign extended to 32 bits.
- Indices larger than integer are truncated to 32 bits.
- The ordering is signed numerical.

4.9.5 Signed packed array

```
Example: typedef bit signed [4:1] Nibble;
        int array_name [ Nibble ];
```

Associative arrays that specify a signed packed array index have the following properties:

- Indices can be any integral expression.
- Indices are signed.
- Indices smaller than the size of the index type are sign extended.
- Indices larger than the size of the index type are truncated to the size of the index type.
- The ordering is signed numerical.

4.9.6 Unsigned packed array or packed struct

```
Example: typedef bit [4:1] Nibble;
        int array_name [ Nibble ];
```

Associative arrays that specify an unsigned packed array index have the following properties:

- Indices can be any integral expression.
- Indices are unsigned.
- A 4-state Index containing X or Z is invalid.
- Indices smaller than the size of the index type are zero filled.
- Indices larger than the size of the index type are truncated to the size of the index type.
- The ordering is numerical.

If an invalid index (i.e., 4-state expression has X's) is used during a read operation or an attempt is made to read a non-existent entry then a warning is issued and the default initial value for the array type is returned, as shown in the table below:

Table 4-1: Value read from a nonexistent associative array entry

Type of Array	Value Read
4-state integral type	'X
2-state integral type	'0
enumeration	first element in the enumeration
string	""
class	null
event	null

If an invalid index is used during a write operation, the write is ignored and a warning is issued.

4.9.7 Other user defined types

LRM 60

Example:

```
typedef struct {real R; int I[*];} Unpkt;
```

```
int array_name [ Unpkt ];
```

In general, associative arrays that specify an index of any type have the following properties:

- Declared Indices must have the equality operator defined for its type to be legal. This includes all of the dynamically sized types as legal Index types
- An Index expression that is or contains X or Z in any of its elements is invalid.
- An Index expression that is or contains an empty value or null for any of its elements does not make the Index invalid.
- If the relational operator is defined for the Index type, the ordering is as defined in the preceding sections. If not, the relative ordering of any two entries in such an associative array can vary, even between successive runs of the same tool. However, the relative ordering must remain the same within the same simulation run while no Indices have been added or deleted.

4.10 Associative array methods

In addition to the indexing operators, several built-in methods are provided that allow users to analyze and manipulate associative arrays, as well as iterate over its indices or keys.

4.10.1 num()

The syntax for the `num()` method is:

```
function int num();
```

The `num()` method returns the number of entries in the associative array. If the array is empty, it returns 0.

```
int imem[*];
imem[ 2'b3 ] = 1;
imem[ 16'hffff ] = 2;
imem[ 4b'1000 ] = 3;
$display( "%0d entries\n", imem.num ); // prints "3 entries"
```

4.10.2 delete()

The syntax for the `delete()` method is:

```
function void delete( [input index] );
```

Where *index* is an optional index of the appropriate type for the array in question.

If the *index* is specified, then the `delete()` method removes the entry at the specified index. If the entry to be deleted does not exist, the method issues no warning.

If the *index* is not specified, then the `delete()` method removes all the elements in the array.

```
int map[ string ];
map[ "hello" ] = 1;
map[ "sad" ] = 2;
map[ "world" ] = 3;
map.delete( "sad" ); // remove entry whose index is "sad" from "map"
map.delete; // remove all entries from the associative array "map"
```

4.10.3 exists()

The syntax for the `exists()` method is:

```
function int exists( input index );
```

Where *index* is an index of the appropriate type for the array in question.

The `exists()` function checks if an element exists at the specified index within the given array. It returns 1 if the element exists, otherwise it returns 0.

```
if ( map.exists( "hello" ))
    map[ "hello" ] += 1;
else
    map[ "hello" ] = 0;
```

4.10.4 first()

The syntax for the `first()` method is:

```
function int first( ref index );
```

Where *index* is an index of the appropriate type for the array in question.

The `first()` method assigns to the given index variable the value of the first (smallest) index in the associative array. It returns 0 if the array is empty, and 1 otherwise.

```
string s;
if ( map.first( s ) )
    $display( "First entry is : map[ %s ] = %0d\n", s, map[s] );
```

4.10.5 last()

The syntax for the `last()` method is:

```
function int last( ref index );
```

Where *index* is an index of the appropriate type for the array in question.

The `last()` method assigns to the given index variable the value of the last (largest) index in the associative array. It returns 0 if the array is empty, and 1 otherwise.

```
string s;
if ( map.last( s ) )
    $display( "Last entry is : map[ %s ] = %0d\n", s, map[s] );
```

4.10.6 next()

The syntax for the `next()` method is:

```
function int next( ref index );
```

Where *index* is an index of the appropriate type for the array in question.

The `next()` method finds the entry whose index is greater than the given index. If there is a next entry, the index variable is assigned the index of the next entry, and the function returns 1. Otherwise, *index* is unchanged, and the function returns 0.

```
string s;
if ( map.first( s ) )
    do
        $display( "%s : %d\n", s, map[ s ] );
```

```
while ( map.next( s ) );
```

4.10.7 prev()

The syntax for the `prev()` method is:

```
function int prev( ref index );
```

Where *index* is an index of the appropriate type for the array in question.

The `prev()` function finds the entry whose index is smaller than the given index. If there is a previous entry, the index variable is assigned the index of the previous entry, and the function returns 1. Otherwise, the index is unchanged, and the function returns 0.

```
string s;
if ( map.last( s ) )
  do
    $display( "%s : %d\n", s, map[ s ] );
  while ( map.prev( s ) );
```

If the argument passed to any of the four associative array traversal methods `first`, `last`, `next`, and `prev` is smaller than the size of the corresponding index, then the function returns `-1` and shall copy only as much data as can fit into the argument. For example:

```
string aa[*];
byte ix;
int status;
aa[ 1000 ] = "a";
status = aa.first( ix );
// status is -1
// ix is 232 (least significant 8 bits of 1000)
```

4.11 Associative array assignment

Associative arrays can be assigned only to another associative array of a compatible type and with the same index type. Other types of arrays cannot be assigned to an associative array, nor can associative arrays be assigned to other types of arrays, whether fixed-size or dynamic.

Assigning an associative array to another associative array causes the target array to be cleared of any existing entries, and then each entry in the source array is copied into the target array.

4.12 Associative array arguments

Associative arrays can be passed as arguments only to associative arrays of a compatible type and with the same index type. Other types of arrays, whether fixed-size or dynamic, cannot be passed to subroutines that accept an associative array as an argument. Likewise, associative arrays cannot be passed to subroutines that accept other types of arrays.

Passing an associative array by value causes a local copy of the associative array to be created.

4.13 Associative array literals

Associative array literals use the `{index:value}` syntax with an optional default index. Like all other arrays, an associative array can be written one entry at a time, or the whole array contents can be replaced using an array literal.

```

constant_primary ::=
concatenation ::= //from Annex A.8.1
    ...
    | { array_member_label : expression { , array_member_label : expression } }
array_member_label ::=
    default
    | type_identifier
    | constant_expression
    
```

LRM 275

Syntax 4-2—Associative array literal syntax (excerpt from Annex A)

LRM 265

For example:

```

// an associative array of strings indexed by 2-state integers,
// default is "foo".
string words [int] = {default: "foo"};

// an associative array of 4-state integers indexed by strings, default is -1.
integer table [string] = {"Peter":20, "Paul":22, "Mary":23, default:-1 };
    
```

If a default value is specified, then reading a non-existent element shall yield the specified default value. Otherwise, the default initial value is as described in Table 4-1 shall be returned.

4.14 Queues

LRM 43

A queue is a variable-size, ordered collection of homogeneous elements. A queue supports constant time access to all its elements as well as constant time insertion and removal at the beginning or the end of the queue. Each element in a queue is identified by an ordinal number that represents its position within the queue, with 0 representing the first, and \$ representing the last. A queue is analogous to a one-dimensional unpacked array that grows and shrinks automatically. Thus, like arrays, queues can be manipulated using the indexing, concatenation, slicing operator syntax, and equality operators.

Queues are declared using the same syntax as unpacked arrays, but specifying \$ as the array size. The maximum size of a queue can be limited by specifying its optional right bound (last index).

LRM 160

```

variable_dimension13 ::= //from Annex A.2.5
    { sized_or_undefined_dimension }
    | associative_dimension
    | queue_dimension
queue_dimension ::= [ $ [ : constant_expression ] ]
    
```

Syntax 4-3—Declaration of queue dimension (excerpt from Annex A)

constant_expression must evaluate to a positive integer value.

For example:

```

byte q1[$]; // A queue of bytes
string names[$] = { "Bob" }; // A queue of strings with one element
integer Q[$] = { 3, 2, 7 }; // An initialized queue of integers
bit q2[$:255]; // A queue whose maximum size is 256 bits
    
```

The empty array literal `{}` is used to denote an empty queue. If an initial value is not provided in the declaration, the queue variable is initialized to the empty queue.

4.14.1 Queue Operators

Queues support the same operations that can be performed on unpacked arrays, and using the same operators and rules except as defined below:

```

int q[$] = { 2, 4, 8 };
int p[$];
int e, pos;

e = q[0];           // read the first (left-most) item
e = q[$];          // read the last (right-most) item
q[0] = e;          // write the first item
p = q;             // read and write entire queue (copy)

q = { q, 6 };      // insert '6' at the end (append 6)
q = { e, q };      // insert 'e' at the beginning (prepend e)

q = q[1:$];        // delete the first (left-most) item
q = q[0:$-1];      // delete the last (right-most) item
q = q[1:$-1];      // delete the first and last items

q = {};           // clear the queue (delete all items)

q = { q[0:pos-1], e, q[pos,$] }; // insert 'e' at position pos
q = { q[0:pos], e, q[pos+1,$] }; // insert 'e' after position pos

```

Unlike arrays, the empty queue, `{}`, is a valid queue and the result of some queue operations. The following rules govern queue operators:

- `Q[a : b]` yields a queue with $b - a + 1$ elements.
 - If $a > b$ then `Q[a:b]` yields the empty queue `{}`.
 - `Q[n : n]` yields a queue with one item, the one at position `n`. Thus, `Q[n : n] === { Q[n] }`.
 - If `n` lies outside `Q`'s range ($n < 0$ or $n > \$$) then `Q[n:n]` yields the empty queue `{}`.
 - If either `a` or `b` are 4-state expressions containing `X` or `Z` values, it yields the empty queue `{}`.
- `Q[a : b]` where $a < 0$ is the same as `Q[0 : b]`.
- `Q[a : b]` where $b > \$$ is the same as `Q[a : $]`.
- An invalid index value (i.e., a 4-state expression with `X`'s or `Z`'s, or a value that lies outside `0...$`) shall cause a read operation (`e = Q[n]`) to return the default initial value for the type of queue item (as described in Table 4-1).
- An invalid index (i.e., a 4-state expression with `X`'s or `Z`'s, or a value that lies outside `0...$+1`) shall cause a write operation to be ignored and a run-time warning to be issued. Note that writing to `Q[$+1]` is legal.
- A queue declared with a right bound `[$:N]` shall be limited to the indexes 0 through `N` (its maximum size will be `N+1`). An index that lies outside these limits shall be invalid, therefore, a write operation past the end of the queue shall be ignored and issue a warning. The warning can be issued at either compile time or run time, as soon as it is possible to determine that the index lies outside the queue limit.

LRM 160

NOTE: Queues and dynamic arrays have the same assignment and argument passing semantics.

4.14.2 Queue methods

In addition to the array operators, queues provide several built-in methods.

4.14.2.1 size()

The prototype for the size() method is:

```
function int size();
```

The size() method returns the number of items in the queue. If the queue is empty, it returns 0.

```
for ( int j = 0; j < q.size; j++ ) $display( q[j] );
```

4.14.2.2 insert()

The prototype of the insert() method is:

```
function void insert(int index, queue_type item);
```

The insert() method inserts the given item at the specified index position.

— $Q.insert(i, e)$ is equivalent to: $Q = \{Q[0:i-1], e, Q[i, \$]\}$

4.14.2.3 delete()

The prototype of the delete() method is:

```
function void delete(int index);
```

The delete() method deletes the item at the specified index position.

— $Q.delete(i)$ is equivalent to: $Q = \{Q[0:i-1], Q[i+1, \$]\}$

4.14.2.4 pop_front()

The prototype of the pop_front() method is:

```
function queue_type pop_front();
```

The pop_front() method removes and returns the first element of the queue.

— $e = Q.pop_front()$ is equivalent to: $e = Q[0]$; $Q = Q[1, \$]$

4.14.2.5 pop_back()

The prototype of the pop_back() method is:

```
function queue_type pop_back();
```

The pop_back() method removes and returns the last element of the queue.

— $e = Q.pop_back()$ is equivalent to: $e = Q[\$]$; $Q = Q[0, \$-1]$

4.14.2.6 push_front()

The prototype of the push_front() method is:

```
function void push_front(queue_type item);
```

The push_front() method inserts the given element at the front of the queue.

— $Q.push_front(e)$ is equivalent to: $Q = \{e, Q\}$

4.14.2.7 push_back()

The prototype of the push_back() method is:

```
function void push_back(queue_type item);
```

The push_back() method inserts the given element at the end of the queue.

— `Q.push_back(e)` is equivalent to: `Q = {Q, e}`

4.15 Array manipulation methods

LRM 43

SystemVerilog provides several built-in methods to facilitate array searching, ordering, and reduction.

The general syntax to call these array methods is:

<pre>array_method_call ::= ... † expression . array_method_name { attribute_instance } [(list_of_arguments)] [with (expression)] array_method_name ::= method_identifier unique and or xor</pre>	<p>LRM 248</p> <p>LRM 113 LRM 140</p>
--	---

Syntax 4-4—array method call syntax (~~except from~~ not in Annex A)

The optional **with** clause accepts an expression enclosed in parenthesis. In contrast, the **with** clause used by the `randomize` method (see Section 12.6) accepts a set of constraints enclosed in braces.

LRM 265

4.15.1 Array Locator Methods

Array locator methods operate on any unpacked array, including queues, but their return type is a queue. These locator methods allow searching an array for elements (or their indexes) that satisfy a given expression. Array locator methods traverse the array in an unspecified order. The optional **with** expression should not include any side effects; if it does, the results are unpredictable.

The prototype of these methods is:

```
function array_type [$] locator_method (array_type iterator = item);
// same type as the array
```

or

```
function int_or_index_type [$] index_locator_method(array_type iterator = item);
// index type
```

Index locator methods return a queue of **int** for all arrays except associative arrays, which return a queue of the same type as the associative index type.

If no elements satisfy the given expression or the array is empty (in the case of a queue or dynamic array) then an empty queue is returned, otherwise these methods return a queue containing all items that satisfy the expression. Index locator methods return a queue with the indexes of all items that satisfy the expression. The optional expression specified by the **with** clause must evaluate to a boolean value.

Locator methods iterate over the array elements, which are then used to evaluate the expression specified by the **with** clause. The iterator argument optionally specifies the name of the variable used by the **with** expression to designate the element of the array at each iteration. If it is not specified, the name `item` is used by

default. The scope for the iterator name is the **with** expression.

The following locator methods are supported (the **with** clause is mandatory) :

- `find()` returns all the elements satisfying the given expression
- `find_index()` returns the indexes of all the elements satisfying the given expression
- `find_first()` returns the first element satisfying the given expression
- `find_first_index()` returns the index of the first element satisfying the given expression
- `find_last()` returns the last element satisfying the given expression
- `find_last_index()` returns the index of the last element satisfying the given expression

For the following locator methods the **with** clause (and its expression) can be omitted if the relational operators (`<`, `>`, `==`) are defined for the element type of the given array. If a **with** clause is specified, the relational operators (`<`, `>`, `==`) must be defined for the type of the expression.

- `min()` returns the element with the minimum value or whose expression evaluates to a minimum
- `max()` returns the element with the maximum value or whose expression evaluates to a maximum
- `unique()` returns all elements with unique values or whose expression is unique
- `unique_index()` returns the indexes of all elements with unique values or whose expression is unique

Examples:

```

string SA[10], qs[$];
int IA[*], qi[$];

// Find all items greater than 5
qi = IA.find( x ) with ( x > 5 );

// Find indexes of all items equal to 3
qi = IA.find_index with ( item == 3 );

// Find first item equal to Bob
qs = SA.find_first with ( item == "Bob" );

// Find last item equal to Henry
qs = SA.find_last( y ) with ( y == "Henry" );

// Find index of last item greater than Z
qi = SA.find_last_index( s ) with ( s > "Z" );

// Find smallest item
qi = IA.min;

// Find string with largest numerical value
qs = SA.max with ( item.atoi );

// Find all unique strings elements
qs = SA.unique;

// Find all unique strings in lower-case
qs = SA.unique( s ) with ( s.tolower );

```

4.15.2 Array ordering methods

Array ordering methods can reorder the elements of one-dimensional arrays or queues.

The general prototype for the ordering methods is:

```
function void ordering_method ( array_type iterator = item )
```

The following ordering methods are supported:

- `reverse()` reverses all the elements of the array (packed or unpacked). Specifying a **with** clause shall be a compiler error.
- `sort()` sorts the unpacked array in ascending order, optionally using the expression in the **with** clause. The **with** clause (and its expression) is optional when the relational operators are defined for the array element type.
- `rsort()` sorts the unpacked array in descending order, optionally using the expression in the **with** clause. The **with** clause (and its expression) is optional when the relational operators are defined for the array element type.
- `shuffle()` randomizes the order of the elements in the array. Specifying a **with** clause shall be a compiler error.

Examples:

```
string s[] = { "hello", "sad", "world" };
s.reverse;           // s becomes { "world", "sad", "hello" };

logic [4:1] b = 4'bXZ01;
b.reverse;          // b becomes 4'b10ZX

int q[$] = { 4, 5, 3, 1 };
q.sort;             // q becomes { 1, 3, 4, 5 }

struct { byte red, green, blue } c [512];
c.sort with ( item.red ); // sort c using the red field only
c.sort( x ) with ( x.blue << 8 + x.green ); // sort by blue then green
```

4.15.3 Array reduction methods

Array reduction methods can be applied to any unpacked array to reduce the array to a single value. The expression within the optional **with** clause can be used to specify the item to use in the reduction.

The prototype for these methods is:

```
function expression_or_array_type reduction_method (array_type iterator = item)
```

The method returns a single value of the same type as the array element type or, if specified, the type of the expression in the **with** clause. The **with** clause can be omitted if the corresponding arithmetic or boolean reduction operation is defined for the array element type. If a **with** clause is specified, the corresponding arithmetic or boolean reduction operation must be defined for the type of the expression.

The following reduction methods are supported:

- `sum()` returns the sum of all the array elements, or if a **with** clause is specified, returns the sum of the values yielded by evaluating the expression for each array element.
- `product()` returns the product of all the array elements, or if a **with** clause is specified, returns the product of the values yielded by evaluating the expression for each array element.

- `and()` returns the bit-wise AND (`&`) of all the array elements, or if a `with` clause is specified, returns the bit-wise AND of the values yielded by evaluating the expression for each array element
- `or()` returns the bit-wise OR (`|`) of all the array elements, or if a `with` clause is specified, returns the bit-wise OR of the values yielded by evaluating the expression for each array element
- `xor()` returns the logical XOR (`^`) of all the array elements, or if a `with` clause is specified, returns the XOR of the values yielded by evaluating the expression for each array element

Examples:

```
byte b[] = { 1, 2, 3, 4 };
int y;

y = b.sum ; // y becomes 10 => 1 + 2 + 3 + 4
y = b.product ; // y becomes 24 => 1 * 2 * 3 * 4
y = b.xor with ( item + 4 ); // y becomes 12 => 5 ^ 6 ^ 7 ^ 8
```

4.15.4 Iterator index querying

The expressions used by array manipulation methods sometimes need the actual array indexes at each iteration, not just the array element. The `index` method of an iterator returns the index value of the specified dimension. The prototype of the `index` method is:

```
function int_or_index_type index ( int dimension = 1 )
```

The array dimensions are numbered as defined in [Section 23.4](#) [Section 23.7](#): The slowest varying is dimension 1. Successively faster varying dimensions have sequentially higher dimension numbers. If the dimension is not specified, the first dimension is used by default

LRM 263

The return type of the `index` method is an `int` for all array iterator items except associative arrays, which returns an index of the same type as the associative index type.

For example:

```
int arr[]
int mem[9:0][9:0], mem2[9:0][9:0];
int q[$];
...

// find all items equal to their position (index)
q = arr.find with ( item == item.index );

// find all items in mem that are greater than corresponding item in mem2
q = mem.find( x ) with ( x > mem2[x.index(1)][x.index(2)] );
```

Section 5

Data Declarations

5.1 Introduction (informative)

There are several forms of data in SystemVerilog: literals (see Section 2), parameters (see Section 21), constants, variables, nets, and attributes (see Section 6)

Verilog 2001 constants are literals, genvars, parameters, localparams and specparams. Verilog 2001 also has variables and nets. Variables must be written by procedural statements, and nets must be written by continuous assignments or ports.

LRM 20

SystemVerilog extends the functionality of variables by allowing them to either be written by procedural statements or driven by a single continuous assignment, similar to a **wire**. Since the keyword **reg** no longer describes the users intent in many cases, the keyword **logic** is added as a more accurate description that is equivalent to **reg**. Verilog-2001 has already deprecated the use of the term *register* in favor of *variable*.

SystemVerilog follows Verilog by requiring data to be declared before it is used, apart from implicit nets. The rules for implicit nets are the same as in Verilog-2001.

A variable can be static (storage allocated on instantiation and never de-allocated) or automatic (stack storage allocated on entry to a scope (such as a task, function or block) and de-allocated on exit). C has the keywords **static** and **auto**. SystemVerilog follows Verilog in respect of the static default storage class, with automatic tasks and functions, but allows **static** to override a default of **automatic** for a particular variable in such tasks and functions.

LRM 21

LRM 157

5.2 Data declaration syntax

```
data_declaration16 ::=                                     // from Annex A.2.1.3
    [ const ] [ lifetime ] variable_declaration
    | type_declaration
    | package_import_declaration
    | virtual_interface_declaration
variable_declaration ::=
    data_type list_of_variable_decl_assignments ;
lifetime ::= static | automatic
```

LRM 22
LRM 35LRM 56
LRM 59
LRM 90

16). In a data_declaration that is not within the procedural context, it shall be illegal to use the **automatic** keyword

Syntax 5-1—Data declaration syntax (excerpt from Annex A)

5.3 Constants

Constants are named data variables which never change. There are three kinds of constants, declared with the keywords **localparam**, **specparam** and **const**, respectively. All three can be initialized with a literal.

LRM 56

```
localparam byte colon1 = ":" ;
specparam int delay = 10 ; // specparams are used for specify blocks
const logic flag = 1 ;
```

A parameter or local parameter can only be set to an expression of literals, parameters or local parameters, genvars, enumerated names, or a constant function of these. Hierarchical names are not allowed.

LRM 91

A `specparam` can also be set to an expression containing one or more `specparams`.

A `static` constant declared with the `const` keyword can only be set to an expression of literals, parameters, local parameters, genvars, enumerated names, a constant function of these, or other constants. The parameters, local parameters or constant functions can have hierarchical names. ~~This is because the `static` constants declared with the `const` keyword are calculated after elaboration.~~ An automatic constant declared with the `const` keyword can be set to any expression that would be legal without the `const` keyword.

LRM 223

LRM 91

```
const logic option = a.b.c ;
```

A constant expression contains literals and other named constants.

An instance of a class (an object handle) can also be declared with the `const` keyword.

```
const class_name object = new(5,3) ;
```

This means that the object acts like a variable that cannot be written. The arguments to the `new` method must be constant expressions. The members of the object can be written (except for those members that are declared `const`).

LRM 47

SystemVerilog enhancements to `parameter` and `localparam` constant declarations are presented in Section 21. SystemVerilog does not change ~~`localparam` and `specparam`~~ constants declarations. A `const` form of constant differs from a `localparam` constant in that the `localparam` must be set during elaboration, whereas a `const` can be set during simulation, such as in an automatic task.

LRM 225

5.4 Variables

A variable declaration consists of a data type followed by one or more instances.

```
shortint s1, s2[0:9] ;
```

A variable can be declared with an initializer, for example:

```
int i = 0 ;
```

LRM 28

In Verilog-2001, an initialization value specified as part of the declaration is executed as if the assignment were made from an initial block, after simulation has started. Therefore, the initialization can cause an event on that variable at simulation time zero.

In SystemVerilog, setting the initial value of a static variable as part of the variable declaration (including static class members) shall occur before any `initial` or `always` blocks are started, and so does not generate an event. If an event is needed, an `initial` block should be used to assign the initial values.

Initial values in SystemVerilog are not constrained to simple constants; they can include run-time expressions, including dynamic memory allocation. For example, a static class handle or a mailbox can be created and initialized by calling its `new` method (see [Annex 11.4](#) Section 13.3.1), or static variables can be initialized to random values by calling the `$urandom` system task. This requires a special pre-initial pass at run-time.

LRM 117

The following table contains the default values for SystemVerilog variables.

Table 5-1: Default values

Type	Default Initial value
4 state integral	'X
2 state integral	'0

Table 5-1: Default values

Type	Default Initial value
real, shortreal	0.0
Enumeration	First value in the enumeration
string	" " (empty string)
event	New event
class	null
chandle (Opaque handle)	null

5.5 Scope and lifetime

Any data declared outside a module, interface, task, or function, is global in scope (can be used anywhere after its declaration) and has a static lifetime (exists for the whole elaboration and simulation time).

SystemVerilog data declared inside a module or interface but outside a task, process or function is local in scope and static in lifetime (exists for the lifetime of the module or interface). This is roughly equivalent to C static data declared outside a function, which is local to a file.

Data declared in an automatic task, function or block has the lifetime of the call or activation and a local scope. This is roughly equivalent to a C automatic variable.

Data declared in a static task, function or block defaults to a static lifetime and a local scope.

LRM 29

Note that in SystemVerilog, data can be declared in unnamed blocks as well as in named blocks. This data is visible to the unnamed block and any nested blocks below it. Hierarchical references cannot be used to access this data by name.

Verilog-2001 allows tasks and functions to be declared as **automatic**, making all storage within the task or function automatic. SystemVerilog allows specific data within a static task or function to be explicitly declared as **automatic**. Data declared as automatic has the lifetime of the call or block, and is initialized on each entry to the call or block. The lifetime of a **fork...join**, **fork...join_any**, or **fork...join_none** block shall encompass the execution of all processes spawned by the block. The lifetime of a scope enclosing any **fork...join** block includes the lifetime of the **fork...join** block.

LRM 67

SystemVerilog also allows data to be explicitly declared as **static**. Data declared to be **static** in an automatic task, ~~or~~ function or block has a static lifetime and a scope local to the block. This is like C static data declared within a function.

LRM 193

LRM 201

```

module msl;
  int st0; // static
  initial begin
    int st1; //static
    static int st2; //static
    automatic int auto1; //automatic
  end
  task automatic t1();
    int auto2; //automatic
    static int st3; //static
    automatic int auto3; //automatic
  endtask
endmodule

```

SystemVerilog adds an optional qualifier to specify the default lifetime of all variables declared in task, function or block defined within a module, interface or program (see Section 16). The lifetime qualifier is **automatic** or **static**. The default lifetime is **static**.

LRM 118

```

program automatic test ;
    int i;           // not within a procedural block - static
    task foo( int a ); // arguments and variables in foo are automatic
    ...
    endtask
endmodule

```

Class methods and declared **for** loop variables are by default automatic, regardless of the lifetime attribute of the scope in which they are declared. Classes are discussed in Section 11.

Note that automatic or dynamic variables cannot be written with nonblocking or continuous assignments. Automatic variables and dynamic constructs—objects handles, dynamic arrays, associative arrays, strings, and event variables—shall be limited to the procedural context.

LRM 36

LRM 59

See also Section 10 on tasks and functions.

5.6 Nets, regs, and logic

Verilog-2001 states that a net can be written by one or more continuous assignments, primitive outputs or through module ports. The resultant value of multiple drivers is determined by the resolution function of the net type. A net cannot be procedurally assigned. If a net on one side of a port is driven by a variable on the other side, a continuous assignment is implied. A force statement can override the value of a net. When released, it returns to resolved value.

Verilog-2001 also states that one or more procedural statements can write to variables, including procedural continuous assignments. The last write determines the value. A variable cannot be continuously assigned. The force statement overrides the procedural assign statement, which in turn overrides the normal assignments. A variable cannot be written through a port; it must go through an implicit continuous assignment to a net.

In SystemVerilog, all variables can now be written either by one continuous assignment, or by one or more procedural statements, including procedural continuous assignments. It shall be an error to have multiple continuous assignments or a mixture of procedural and continuous assignments writing to any term in the expansion of a written longest static prefix of a logic variable (See Section 9.2.1 for the definition of the expansion of a longest static prefix). All data types can write through a port.

LRM 4

SystemVerilog variables can be packed or unpacked aggregates of other types. Multiple assignments made to independent elements of a variable are examined individually. An assignment where the left-hand-side contains a slice is treated as a single assignment to the entire slice. It shall be an error to have a packed structure or array type written with a mixture of procedural and continuous assignments. Thus, an unpacked structure or array can have one element assigned procedurally, and another element assigned continuously. And, each element of a packed structure or array can each have a single continuous assignment. For example, assume the following structure declaration:

```

struct {
    bit [7:0] A;
    bit [7:0] B;
    byte C;
} abc;

```

The following statements are legal assignments to struct abc:

```

assign abc.C = sel ? 8'hBE : 8'hEF;

not (abc.A[0], abc.B[0]),

```

```
(abc.A[1], abc.B[1]),
(abc.A[2], abc.B[2]),
(abc.A[3], abc.B[3]);
```

```
always @(posedge clk) abc.B <= abc.B + 1;
```

The following additional statements are illegal assignments to struct abc:

```
// Multiple continuous assignments to abc.C
assign abc.C = sel ? 8'hDE : 8'hED;

// Mixing continuous and procedural assignments to abc.A
always @(posedge clk) abc.A[7:4] <= !abc.B[7:4];
```

For the purposes of the preceding rule, a declared variable initialization or a procedural continuous assignment is considered a procedural assignment. A **force** statement is neither a continuous or procedural assignment. A **release** statement shall not change the variable until there is another procedural assignment, or shall schedule a re-evaluation of the continuous assignment driving it. A single **force** or **release** statement shall not be applied to a whole or part of a variable that is being assigned by a mixture of continuous and procedural assignments.

A continuous assignment is implied when a variable is connected to an input port declaration. This makes assignments to a variable declared as an input port illegal. A continuous assignment is implied when a variable is connected to the output port of an instance. This makes procedural or continuous assignments to a variable connected to the output port of an instance illegal.

SystemVerilog variables cannot be connected to either side of an inout port. SystemVerilog introduces the concept of shared variables across ports with the ref port type. See Section 18.12 (port connections) for more information about ports and port connection rules.

The compiler can issue a warning if a continuous assignment could drive strengths other than St0, St1, StX, or HiZ to a variable. In any case, SystemVerilog applies automatic type conversion to the assignment, and the strength is lost.

Note that a SystemVerilog variable cannot have an implicit continuous assignment as part of its declaration, the way a net can. An assignment as part of the logic declaration is a variable initialization, not a continuous assignment. For example:

```
wire w = vara & varb;           // continuous assignment

logic v = consta & constb;     // initial procedural assignment

logic vw; // no initial assignment
assign vw = vara & varb;       // continuous assignment to a logic

real circ;
assign circ = 2.0 * PI * R;     // continuous assignment to a real
```

5.7 Signal aliasing

The Verilog **assign** statement is a unidirectional assignment and can incorporate a delay and strength change. To model a bidirectional short-circuit connection it is necessary to use the **alias** statement. The members of an alias list are signals whose bits share the same physical nets. The example below implements a byte order swapping between bus A and bus B.

```
module byte_swap (inout wire [31:0] A, inout wire [31:0] B);
    alias {A[7:0], A[15:8], A[23:16], A[31:24]} = B;
endmodule
```

This example strips out the least and most significant bytes from a four byte bus:

```
module byte_rip (inout wire [31:0] W, inout wire [7:0] LSB, MSB);
    alias W[7:0] = LSB;
    alias W[31:24] = MSB;
endmodule
```

The bit overlay rules are the same as those for a packed union with the same member types: each member shall be the same size, and connectivity is independent of the simulation host. The nets connected with an alias statement must be type compatible, that is, they have to be of the same net type. For example, it is illegal to connect a **wand** net to a **wor** net with an **alias** statement. This is a stricter rule than applied to nets joining at ports because the scope of an alias is limited and such connections are more likely to be a design error. Variables and hierarchical references cannot be used in **alias** statements. Any violation of these rules shall be considered a fatal error.

The same nets can appear in multiple alias statements. The effects are cumulative. The following two examples are equivalent. In either case, `low12[11:4]` and `high12[7:0]` share the same wires.

```
module overlap(inout wire [15:0] bus16, inout wire [11:0] low12, high12);
    alias bus16[11:0] = low12;
    alias bus16[15:4] = high12;
endmodule

module overlap(inout wire [15:0] bus16, inout wire [11:0] low12, high12);
    alias bus16 = {high12, low12[3:0]};
    alias high12[7:0] = low12[11:4];
endmodule
```

To avoid errors in specification, it is not allowed to specify an alias from an individual signal to itself, or to specify a given alias more than once. The following version of the code above would be illegal since the top four and bottom four bits are the same in both statements:

```
alias bus16 = {high12[11:8], low12};
alias bus16 = {high12, low12[3:0]};
```

This alternative is also illegal because the bits of `bus16` are being aliased to itself:

```
alias bus16 = {high12, bus16[3:0]} = {bus16[15:12], low12};
```

Alias statements can appear anywhere module instance statements can appear. If an identifier that has not been declared as a data type appears in an alias statement, then an implicit net is assumed, following the same rules as implicit nets for a module instance. The following example uses **alias** along with the automatic name binding to connect pins on cells from different libraries to create a standard macro:

```
module lib1_dff(Reset, Clk, Data, Q, Q_Bar);
    ...
endmodule

module lib2_dff(reset, clock, data, a, qbar);
    ...
endmodule

module lib3_dff(RST, CLK, D, Q, Q_);
    ...
endmodule

macromodule my_dff(rst, clk, d, q, q_bar); // wrapper cell
    input rst, clk, d;
    output q, q_bar;
```

```

alias rst = Reset = reset = RST;
alias clk = Clk = clock = CLK;
alias d = data = D;
alias q = Q;
alias Q_ = q_bar = Q_Bar = qbar;
`LIB_DFF my_dff (.*); // LIB_DFF is any of lib1_dff, lib2_dff or lib3_dff
endmodule

```

Using a net in an alias statement does not modify its syntactic behavior in other statements. Aliasing is performed at elaboration time and cannot be undone.

5.8 Type compatibility

LRM 111

Some SystemVerilog constructs and operations require a certain level of type compatibility for their operands to be legal. There are four levels of type compatibility, formally defined here: Equivalent, Assignment Compatible, Cast Compatible, and Non-Equivalent.

Note that there is no category for identical types defined here because there is no construct in the SystemVerilog language that requires it. For example, as defined below, **int** can be interchanged with **bit signed [0:31]** wherever it is syntactically legal to do so. Users can define their own level of type identity by using the `$typename` system function (see Section 23.3, Typename function), or through use of the PLI.

5.8.1 Equivalent Types

Two data types shall be defined as equivalent data types using the following inductive definition. If the two data types are not defined equivalent using the following definition, then they shall be defined to be non-equivalent.

- 1) Any built-in type is equivalent to every other occurrence of itself, in every scope.
- 2) A simple typedef or type parameter override that renames a built-in or user defined type is equivalent to that built-in or user defined type within the scope of the type identifier.

```

typedef bit node; // 'bit' and 'node' are equivalent types
typedef type1 type2; // 'type1' and 'type2' are equivalent types

```

- 3) An anonymous enum, struct, or union type is equivalent to itself among variables declared within the same declaration statement and no other types.

```

struct {int A; int B;} AB1, AB2; // AB1, AB2 have equivalent types
struct {int A; int B;} AB3; // AB3 is not type equivalent to AB1

```

- 4) A typedef for an enum, unpacked struct, or unpacked union, or a class is equivalent to itself and variables declared using that type within the scope of the type identifier.

```

typedef struct {int A; int B;} AB_t;
AB_t AB1; AB_t AB2; // AB1 and AB2 have equivalent types

typedef struct {int A; int B;} otherAB_t;
otherAB_t AB3; // AB3 is not type equivalent to AB1 or AB2

```

- 5) Packed arrays, packed structures, and built-in integral types are equivalent if they contain the same number of total bits, are either all 2-state or all 4-state, and are either all signed or all unsigned. Note that if any bit of a packed structure or union is 4-state, the entire structure or union is considered 4-state.

```

typedef bit signed [7:0]BYTE; // equivalent to the byte type
typedef struct packed signed {bit[3:0] a, b;} uint8;
// equivalent to the byte type

```

- 6) Unpacked array types are equivalent by having equivalent element types and identical shape. Shape is defined as the number of dimensions and the number of elements in each dimension, not the actual range of the dimension.

```
bit [9:0] A[0:5];
bit [1:10] B[6];
typedef bit [10:1] uint10;
uint10 C[6:1]; // A, B and C have equivalent types
typedef int anint[0:0]; // anint is not type equivalent to int
```

- 7) Explicitly adding signed or unsigned modifiers to a type that does not change its default signing, does not create a non-equivalent type. Otherwise, the signing must match to have equivalence

```
typedef bit unsigned ubit; // type equivalent to bit
```

- 8) A typedef for an enum, unpacked struct, or unpacked union, or a class type declared in a package is always equivalent to itself, regardless of the scope where the type is imported.

The scope of a type identifier includes the hierarchical instance scope. This means that each instance with user defined types declared inside the instance creates a unique type. To have type equivalence among multiple instances of the same module, interface, or program, a type must be declared at higher level in the compilation unit scope than the declaration of the module, interface or program, or imported from a package.

The following example is assumed to be within one compilation unit, although the package declaration need not be in the same unit:

```
package p1;
  typedef struct {int A;} t_1;
endpackage

typedef struct {int A;} t_2;

module sub();
  import p1:t_1;
  parameter type t_3 = int;
  parameter type t_4 = int;
  typedef struct {int A;} t_5;
  t_1 v1; t_2 v2; t_3 v3; t_4 v4; t_5 v5;
endmodule

module top();
  typedef struct {int A;} t_6;
  sub #(.t_3(t_6)) s1 ();
  sub #(.t_3(t_6)) s2 ();

  initial begin
    s1.v1 = s2.v1; // legal - both types from package p1 (rule 8)
    s1.v2 = s2.v2; // legal - both types from $unit (rule 4)
    s1.v3 = s2.v3; // legal - both types from top (rule 2)
    s1.v4 = s2.v4; // legal - both types are int (rule 1)
    s1.v5 = s2.v5; // illegal - types from s1 and s2 (rule 4)
  end
endmodule
```

5.8.2 Assignment Compatible

All equivalent types, and all non-equivalent types that have implicit casting rules defined between them are assignment compatible types. For example, all integral types are assignment compatible. Conversion between assignment compatible types can involve loss of data by truncation or rounding.

Compatibility can be in one direction only. For example, an enum can be converted to an integral type without a cast, but not in the other way around. Implicit casting rules are defined in Section 3 Data Types, and Section 7 Operators and Expressions.

5.8.3 Cast Compatible

All assignment compatible types, plus all non-equivalent types that have defined explicit casting rules are cast compatible types. For example, an integral type requires a cast to be assigned to an enum.

Explicit casting rules are defined in Section 3 Data Types.

5.8.4 Type Incompatible

These are all the remaining non-equivalent types that have no defined implicit or explicit casting rules. Class handles and chandles are type incompatible with all other types.

Section 6 Attributes

6.1 Introduction (informative)

With Verilog-2001, users can add named attributes (properties) to Verilog objects, such as modules, instances, wires, etc. Attributes can also be specified on the extended SystemVerilog constructs and are included as part of the BNF (see Annex A). SystemVerilog also defines a default data type for attributes.

6.2 Default attribute type

The default type of an attribute with no value is `bit`, with a value of 1. Otherwise, the attribute takes the type of the expression.

Section 7

Operators and Expressions

7.1 Introduction (informative)

The SystemVerilog operators are a combination of Verilog and C operators. In both languages, the type and size of the operands is fixed, and hence the operator is of a fixed type and size. The fixed type and size of operators is preserved in SystemVerilog. This allows efficient code generation.

Verilog does not have assignment operators or increment and decrement operators. SystemVerilog includes the C assignment operators, such as +=, and the C increment and decrement operators, ++ and --.

Verilog-2001 added signed nets and **reg** variables, and signed based literals. There is a difference in the rules for combining signed and unsigned integers between Verilog and C. SystemVerilog uses the Verilog-2001 rules.

7.2 Operator syntax

```

assignment_operator ::=                                // from Annex A.6.2
    = | += | -= | *= | /= | %= | &= | |= | ^= | <<= | >>= | <<<= | >>>=

conditional_expression ::=                            // from Annex A.8.3
    expression ? { attribute_instance } expression : expression

unary_operator ::=                                  // from Annex A.8.6
    + | - | ! | ~ | & | ~& | | | ~| | ^ | ~^ | ^~

binary_operator ::=
    + | - | * | / | % | == | != | === | !== | ==? | !=? | && | || | **
    | < | <= | > | >= | & | | | ^ | ^~ | ~^ | >> | << | >>> | <<<

inc_or_dec_operator ::= ++ | --

unary_module_path_operator ::=
    ! | ~ | & | ~& | | | ~| | ^ | ~^ | ^~

binary_module_path_operator ::=
    == | != | && | || | & | | | ^ | ^~ | ~^

```

LRM 100

Syntax 7-1—Operator syntax (excerpt from Annex A)

7.3 Assignment operators

In addition to the simple assignment operator, =, SystemVerilog includes the C assignment operators and special bitwise assignment operators: +=, -=, *=, /=, %=, &=, |=, ^=, <<=, >>=, <<<=, and >>>=. An assignment operator is semantically equivalent to a blocking assignment, with the exception that any left hand side index expression is only evaluated once. For example:

```
a[i] += 2; // same as a[i] = a[i] + 2;
```

In SystemVerilog, an expression can include a blocking assignment, provided it does not have a timing control. Note that such an assignment must be enclosed in parentheses to avoid common mistakes such as using a=b for a==b, or a|=b for a!=b.

```
if ((a=b)) b = (a+=1);
```

```
a = (b = (c = 5));
```

The semantics of such an assignment expression are those of a function which evaluates the right hand side, casts the right hand side to the left hand data type, stacks it, updates the left hand side and returns the stacked value. The type returned is the type of the left hand side data type. If the left hand side is a concatenation, the type returned shall be an unsigned integral value whose bit length is the sum of the length of its operands.

It shall be illegal to include an assignment operator in an event expression, in an expression within a procedural continuous assignment, or in an expression that is not within a procedural statement.

SystemVerilog includes the C increment and decrement assignment operators `++i`, `--i`, `i++` and `i--`. These do not need parentheses when used in expressions. These increment and decrement assignment operators behave as blocking assignments.

The ordering of assignment operations relative to any other operation within an expression is undefined. An implementation can warn whenever a variable is both written and read-or-written within an integral expression or in other contexts where an implementation cannot guarantee order of evaluation. In the following example:

```
i = 10;
j = i++ + (i = i - 1);
```

After execution, the value of `j` can be 18, 19, or 20 depending upon the relative ordering of the increment and the assignment statements.

7.4 Operations on logic and bit types

When a binary operator has one operand of type `bit` and another of type `logic`, the result is of type `logic`. If one operand is of type `int` and the other of type `integer`, the result is of type `integer`.

The operators `!=` and `==` return an X if either operand contains an x or a z, as in Verilog-2001. This is converted to a 0 if the result is converted to type `bit`, e.g. in an `if` statement.

The unary reduction operators (`&` `~&` `|` `~|` `^` `~^`) can be applied to any integer expression (including packed arrays). The operators shall return a single value of type `logic` if the packed type is four valued, and of type `bit` if the packed type is two valued.

```
int i;
bit b = &i;
integer j;
logic c = &j;
```

7.5 Wild equality and wild inequality

SystemVerilog 3.1 introduces the wild-card comparison operators, as described below.

Table 7-1: Wild equality and wild inequality operators

Operator	Usage	Description
<code>=?=</code>	<code>a =?= b</code>	a equals b, X and Z values act as wild cards
<code>!?=</code>	<code>a !=? b</code>	a not equal b, X and Z values act as wild cards

The wild equality operator (`=?=`) and inequality operator (`!?=`) treat X and Z values in a given bit position as a wildcard. A wildcard bit matches any bit value (0, 1,Z, or X) in the value of the expression being compared

against it.

These operators compare operands bit for bit, and return a 1-bit self-determined result. If the operands to the wild-card equality/inequality are of unequal bit length, the operands are extended in the same manner as for the case equality/inequality operators. If the relation is true, the operator yields a 1. If the relation is false, it yields a 0.

The three types of equality (and inequality) operators in SystemVerilog behave differently when their operands contain unknown values (X or Z). The == and != operators result in X if any of their operands contains an X or Z. The === and !== check the 4-state explicitly, therefore, X and Z values shall either match or mismatch, never resulting in X. The ==? and !=? operators treat X or Z as wild cards that match any value, thus, they too never result in X.

7.6 Real operators

Operands of type `shortreal` have the same operation restrictions as Verilog `real` operands. The unary operators ++ and -- can have operands of type `real` and `shortreal` (the increment or decrement is by 1.0). The assignment operators +=, -=, *=, /= can also have operands of type `real` and `shortreal`.

If any operand is `real`, the result is `real`, except before the ? in the ternary operator. If no operand is `real` and any operand is `shortreal`, the result is `shortreal`.

Real operands can also be used in the following expressions:

```
str.realval // structure or union member
realarray[intval] // array element
```

7.7 Size

The number of bits of an expression is determined by the operands and the context, following the same rules as Verilog. In SystemVerilog, casting can be used to set the size context of an intermediate value.

With Verilog, tools can issue a warning when the left and right hand sides of an assignment are different sizes. Using the SystemVerilog size casting, these warnings can be prevented.

7.8 Sign

The following unary operators give the signedness of the operand: ~ ++ -- + -. All other operators shall follow the same rules as Verilog for performing signed and unsigned operations.

7.9 Operator precedence and associativity

Operator precedence and associativity is listed in Table 7-2, below. The highest precedence is listed first.

Table 7-2: Operator precedence and associativity

() [] :: .	left
+ - ! ~ & ~& ~ ^ ~^ ^~ ++ -- (unary)	right
**	left
* / %	left
+ - (binary)	left

Table 7-2: Operator precedence and associativity (continued)

<< >> <<< >>>	left
< <= > >= inside dist	left
== != === !== =?= !? =	left
& (binary)	left
^ ~^ ^~ (binary)	left
(binary)	left
&&	left
	left
?: (conditional operator)	right
->	right
= += -= *= /= %= &= ^= = <<= >>= <<<= >>>= := :/ <=	none
{ } { { } }	concatenation

7.10 Built-in methods

SystemVerilog introduces classes and the method calling syntax, in which a task or function is called using the dot notation (.):

```
object.task_or_function()
```

The object uniquely identifies the data on which the task or function operates. Hence, the method concept is naturally extended to built-in types in order to add functionality that traditionally was done via system tasks or functions. Unlike system tasks, built-in methods are not prefixed with a \$ since they require no special prefix to avoid collisions with user-defined identifiers. Thus, the method syntax allows extending the language without the addition of new keywords or cluttering the global name space with system tasks.

Built-in methods, unlike system tasks, cannot be redefined by users via PLI tasks. Thus, only functions that users should not be allowed to redefine are good candidates for built-in method calls.

In general, a built-in method is preferred over a system task when a particular functionality applies to all data types, or it applies to a specific data type. For example:

```
dynamic_array.size, associative_array.num, and string.len
```

These are all similar concepts, but they represent different things. A dynamic array has a size, an associative array contains a given number of items, and a string has a given length. Using the same system task, such as \$length, for all of them would be less clear and intuitive.

A built-in method can only be associated with a particular data type. Therefore, if some functionality is a simple side effect (i.e., \$stop or \$reset) or it operates on no specific data (i.e., \$random) then a system task must be used.

When a function or task built-in method call specifies no arguments, the empty parenthesis, (), following the task/function name is optional. This is also true for tasks or functions that require arguments, when all arguments have defaults specified. For a method, this rule allows simple calls to appear as properties of the object or built-in type. Similar rules are defined for functions and tasks in Section 10.4.5.

7.10.1 Built-in package

LRM 23

LRM 95

SystemVerilog provides a built-in package that contains system types (e.g., classes), variables, tasks and functions. Users cannot insert additional declarations into the built-in package. The built-in package is implicitly wildcard imported into the compilation-unit scope of every compilation unit (see Section 18.3). Thus, declarations in the built-in package are directly available in any other scope (like system tasks and functions) unless they are redefined by user code.

```
built_in_data_type ::= [ std:: ] data_type_identifier           // not in Annex A
built_in_function_call ::= [ std:: ] built_in_identifier       // not in Annex A
```

The package name `std` followed by the scope resolution operator `::` can be used to unambiguously access names in the built-in package. For example:

```
std::sys_task();           // unambiguously call the system provided sys_task
```

Unlike system tasks and functions, tasks and functions in the built-in package need not be prefixed with a `$` to avoid collisions with user-defined identifiers. This mechanism allows functional extensions to the language in a backward compatible manner, without the addition of new keywords or polluting local name spaces.

7.11 Static Prefixes

LRM 11

LRM 169

Informally, the “longest static prefix” of a select is the longest part of the select for which an analysis tool has known values following elaboration. This concept is used when describing implicit sensitivity lists (see Section 9.2) and when describing error conditions for drivers of logic ports (see Section 5.6). The remainder of this section defines what constitutes the “longest static prefix” of a select.

A field select is defined as a hierarchical name where the **RHS right-hand side** of the last “.” hierarchy separator identifies a field of a variable whose type is a `struct` or `union` declaration. The field select prefix is defined to be the **LHS left-hand side** of final “.” hierarchy separator in a field select.

LRM 222

An indexing select is a single indexing operation. The indexing select prefix is either an identifier or, in the case of a multidimensional select, another indexing select. Array selects, bit selects, part selects, and indexed part selects are examples of indexing selects.

The definition of a static prefix is recursive and is defined as follows:

- 1) an identifier is a static prefix
- 2) a field select is a static prefix if the field select prefix is a static prefix
- 3) an indexing select is a static prefix if the indexing select prefix is a static prefix and the select expression is a constant expression.

The definition of the longest static prefix is defined as follows:

- 1) an identifier that is not the field select prefix or indexing select prefix of an expression that is a static prefix
- 2) a field select that is not the field select prefix or indexing select prefix of an expression that is a static prefix
- 3) an indexing select that is not the field select prefix or indexing select prefix of an expression that is a static prefix.

Examples:

```
localparam p = 7;
```

```

reg [7:0] m [5:1] [5:1];
integer i;

m[1][i] // longest static prefix is m[1]

m[p][1] // longest static prefix is m[p][1]

m[i][1] // longest static prefix is m

```

LRM 265

7.12 Concatenation

LRM 169

Braces ({ }) are used to show concatenation, as in Verilog. The concatenation is treated as a packed vector of bits. It can be used on the left hand side of an assignment or in an expression.

```

logic log1, log2, log3;
{log1, log2, log3} = 3'b111;
{log1, log2, log3} = {1'b1, 1'b1, 1'b1}; // same effect as 3'b111

```

Software tools can generate a warning if the concatenation width on one side of an assignment is different than the expression on the other side. The following examples can give warning of size mismatch:

```

bit [1:0] packedbits = {32'b1,32'b1}; // right hand side is 64 bits
int i = {1'b1, 1'b1}; //right hand side is 2 bits

```

Refer to Sections 2.7 and 2.8 for **more** information on initializing arrays and structures .

LRM 169

LRM 265

SystemVerilog enhances the concatenation operation to allow concatenation of variables of type string. In general, if any of the operands is of type **string**, the concatenation is treated as a string, and all other arguments are implicitly converted to the **string** type (as described in Section 3.7). String concatenation is not allowed on the left hand side of an assignment, only as an expression.

```

string hello = "hello";
string s;
s = { hello, " ", "world" };
$display( "%s\n", s ); // displays 'hello world'
s = { s, " and goodbye" };
$display( "%s\n", s ); // displays 'hello world and goodbye'

```

The replication operator (also called a multiple concatenation) form of braces can also be used with variables of type **string**. In the case of string replication, a non-constant multiplier is allowed.

```

int n = 3;
string s = {n { "boo " }};
$display( "%s\n", s ); // displays 'boo boo boo '

```

Note that unlike bit concatenation, the result of a string concatenation or replication is not truncated. Instead, the destination variable (of type **string**) is resized to accommodate the resulting string.

7.13 Unpacked array expressions

Braces are also used for expressions to assign to unpacked arrays. Unlike in C, the expressions must match element for element, and the braces must match the array dimensions. Each expression item shall be evaluated in the context of an assignment to the type of the corresponding element in the array. This means that the following examples do not give size warnings, unlike the similar assignments above:

LRM 169

```

bit unpackedbits [1:0] = {1,1}; // no size warning as bit can be set to 1
int unpackedints [1:0] = {1'b1, 1'b1}; // no size warning as int can be

```

```
// set to 1'b1
```

The syntax of multiple concatenations can be used for unpacked array expressions as well. Each replication represents a single dimension.

```
unpackedbits = {2 {y}} ; // same as {y, y}
int n[1:2][1:3] = {2{{3{y}}}}; // same as {{y,y,y},{y,y,y}}
```

SystemVerilog determines the context of the braces when used in the context of an assignment. If used in the context of an assignment to an unpacked array, the braces represent an unpacked array literal or expression. Outside the context of an assignment on the right hand side, an explicit cast must be used with the braces to distinguish it from a concatenation.

Note an aggregate expression cannot be used as the target of an assignment. The following is considered illegal:

LRM 222

```
logic [2:0] a [1:0];
logic [2:0] b ,c;

always {b,c} = a; // illegal assignment the braces are not determined to be
// an unpacked array expression
```

It can sometimes be useful to set array elements to a value without having to keep track of how many members there are. This can be done with the **default** keyword:

```
initial unpackedints = {default:2}; // sets elements to 2
```

For more arrays of structures, it is useful to specify one or more matching type keys, as illustrated under structure expressions, below.

```
struct {int a; time b;} abkey[1:0];
abkey = {{a:1, b:2ns}, {int:5, time:$time}};
```

When the braces include a type, or default key, the braces shall not be interpreted as a concatenation for both packed and unpacked array types.

The rules for unpacked array matching are as follows:

- An index:value specifies an explicit value for a keyed element index. The value is evaluated in the context of an assignment to the indexed element and shall be castable to its type. It shall be an error to specify the same index more than once in a single array expression.
- For type:value, if the element or sub array type of the unpacked array is equivalent to this type, then each element or sub array shall be set to the value. The value must be castable to the array element or sub array type. Otherwise, if the unpacked array is multidimensional, then there is a recursive descent into each sub array of the array using the rules in this section and the type and default keys. Otherwise, if the unpacked array is an array of structures, there is a recursive descent into each element of the array using the rules for structure expressions and the type and default keys. If more than one type matches the same element, the last value shall be used.
- For default:value, this key specifies the default value to use for each element of an unpacked array that has not been covered by the earlier rules in this section. The value is evaluated in the context of each assignment to an element covered by the default and must be castable to the array element type.

Every element shall be covered by one of these rules.

If the type key, default key, or replication operator is used on an expression with side effects, the number of times that expression evaluates is undefined.

LRM 265

7.14 Structure expressions

A structure expression (packed or unpacked) can be built from member expressions using braces and commas, with the members in declaration order. [Replicate operators can be used to set the values for the exact number of members.](#) Each member expression shall be evaluated in the context of an assignment to the type of the corresponding member in the structure. It can also be built with the names of the members

LRM 222

LRM 169

```

module mod1;

    typedef struct {
        int x;
        int y;
    } st;

    st s1;
    int k = 1;

    initial begin
        #1 s1 = {1, 2+k};           // by position
        #1 $display( s1.x, s1.y);
        #1 s1 = {x:2, y:3+k};     // by name
        #1 $display( s1);
        #1 $finish;
    end
endmodule

```

It can sometimes be useful to set structure members to a value without having to keep track of how many members there are, or what the names are. This can be done with the **default** keyword:

```

initial s1 = {default:2}; // sets x and y to 2

```

The {member:value} or {data_type: default_value} syntax can also be used:

```

ab abkey[1:0] = {{a:1, b:1.0}, {int:2, shortreal:2.0}};

```

Note that the **default** keyword applies to members in nested structures or elements in unpacked arrays in structures. In fact, it descends the nesting to a built-in type or a packed array of them.

```

struct {
    int A;
    struct {
        int B, C;
    } BC1, BC2;
}

ABC = {A:1, BC1:{B:2, C:3}, BC2:{B:4,C:5}};
DEF = {default:10};

```

To deal with the problem of members of different types, a type can be used as the key. This overrides the default for members of that type:

```

typedef struct {
    logic [7:0] a;
    bit b;
    bit [31:0] c;
    string s;
} sa;

sa s2;

```

```
initial s2 = {bit[31:0]:1, default:0, string:""}; // set all to 0 except the
                                                // array of bits to 1 and
                                                // string to ""
```

Similarly, an individual member can be set to override the general default and the type default:

```
initial #10 s1 = {default:'1, s = ""}; // set all to 1 except s to ""
```

SystemVerilog determines the context of the braces when used in the context of an assignment. If used in the context of an assignment to an unpacked structure, the braces represent an unpacked structure literal or expression. Outside the context of an assignment to an aggregate type, an explicit cast must be used with the braces to distinguish it from a concatenation. When the braces include a label, type, or default key, the braces shall not be interpreted as a concatenation for both packed and unpacked structure types.

LRM 169

The matching rules are as follows:

- A `member:value` specifies an explicit value for a named member of the structure. The named member must be at the top level of the structure—a member with the same name in some level of substructure shall not be set. The value must be castable to the member type and is evaluated in the context of an assignment to the named member, otherwise an error is generated.
- The `type:value` specifies an explicit value for a field in the structure which is equivalent to the type and has not been set by a field name key above. If the same type key is mentioned more than once, the last value is used. The value is evaluated in the context of an assignment to the matching type.
- The `default:value` applies to members that are not matched by either member name or type key and are not either structures or unpacked arrays. The value is evaluated in the context of each assignment to a member by the default and must be castable to the member type, otherwise an error is generated. For unmatched structure members, the type and default specifiers are applied recursively according to the rules in this section to each member of the substructure. For unmatched unpacked array members, the type and default keys are applied to the array according to the rules for unpacked arrays.

Every member must be covered by one of these rules.

⊛ If the type key, default key, or replication operator is used on an expression with side effects, the number of times that expression evaluates is undefined.

LRM 222

7.15 Tagged union expressions and member access

LRM 122

```
expression ::= // from Annex A.8.3
    ...
    | tagged_union_expression
tagged_union_expression ::=
    tagged member_identifier [ expression ]
```

Syntax 7-2—Tagged union syntax (excerpt from Annex A)

A tagged union expression (packed or unpacked) is expressed using the keyword `tagged` followed by a tagged union member identifier, followed by an expression representing the corresponding member value. For `void` members the member value expression is omitted.

Example:

```
typedef union tagged {
    void Invalid;
    int Valid;
```

```

} VInt;

VInt vi1, vi2;

vi1 = tagged Valid (23+34); // Create Valid int
vi2 = tagged Invalid;      // Create an Invalid value

```

In the tagged union expressions below, the expressions in braces are structure expressions (Section 7.14).

```

typedef union tagged {
    struct {
        bit [4:0] reg1, reg2, regd;
    } Add;
    union tagged {
        bit [9:0] JumpU;
        struct {
            bit [1:0] cc,
            bit [9:0] addr;
        } JumpC;
    } Jump;
} Instr;

Instr i1, i2;

// Create an Add instruction with its 3 register fields
i1 = ( e
    ? tagged Add { e1, 4, ed }; // struct members by position
    : tagged Add { reg2:e2, regd:3, reg1:19 }); // by name (order irrelevant)

// Create a Jump instruction, with "unconditional" sub-opcode
i1 = tagged Jump (tagged tagged JumpU 239);

// Create a Jump instruction, with "conditional" sub-opcode
i2 = tagged Jump (tagged tagged JumpC { 2, 83 }); // inner struct by position
i2 = tagged Jump (tagged tagged JumpC { cc:2, addr:83 }); // by name

```

LRM 265

The type of a tagged union expression must be known from its context (e.g., it is used in the **RHS right-hand side** of an assignment to a variable whose type is known, or it is has a cast, or it is used inside another expression from which its type is known). The expression evaluates to a tagged union value of that type. The tagged union expression can be completely type-checked statically: the only member names allowed after the **tagged** keyword are the member names for the expression type, and the member expression must have the corresponding member type.

LRM 222

An uninitialized variable of tagged union type shall be undefined. This includes the tag bits. A variable of tagged union type can be initialized with a tagged union expression provided the member value expression is a legal initializer for the member type.

Members of tagged unions can be read or assigned using the usual dot-notation. Such accesses are completely type-checked, i.e., the value read or assigned must be consistent with the current tag. In general, this can require a runtime check. An attempt to read or assign a value whose type is inconsistent with the tag results in a runtime error.

All the following examples are legal only if the instruction variable `instr` currently has tag `Add`:

```

x = i1.Add.reg1;
i1.Add = {19, 4, 3};
i1.Add.reg2 = 4;

```

7.16 Aggregate expressions

Unpacked structure and array variables, literals, and expressions can all be used as aggregate expressions. A multi-element slice of an unpacked array can also be used as an aggregate expression.

Aggregate expressions can be copied in an assignment, through a port, or as an argument to a task or function. Aggregate expressions can also be compared with equality or inequality operators. To be copied or compared, the type of an aggregate expression must be assignment compatible. See Section 5.8.2 Assignment compatible types.

LRM 198

LRM 111

7.17 Operator overloading

LRM 77

There are various kinds of arithmetic that can be useful: saturating, arbitrary size floating point, carry save etc. It is convenient to use the normal arithmetic operators for readability, rather than relying on function calls.

```

overload_declaration ::=                                     // from Annex A.2.8
    bind overload_operator function data_type function_identifier ( overload_proto_formals ) ;
overload_operator ::= + | ++ | - | -- | * | ** | / | % | == | != | < | <= | > | >= | =
overload_proto_formals ::= data_type { , data_type }

```

Syntax 7-3—Operator overloading syntax (excerpt from Annex A)

The overload declaration allows the arithmetic operators to be applied to data types that are normally illegal for them, such as unpacked structures. It does not change the meaning of the operators for those types where it is legal to apply them. This means that such code does not change behavior when operator overloading is used.

The overload declaration links an operator to a function prototype. The arguments are matched, and the type of the result is then checked. Multiple functions can have the same arguments and different return types. If no expected type exists because the operator is in a self-determined context, then a cast must be used to select the correct function. Similarly if more than one expected type is possible, due to nested operators, and could match more than one function, a cast must be used to select the correct function.

An expected result type exists in any of the following contexts:

- Right hand side of an assignment or assignment expression
- Actual input argument of a task or function call
- Input port connection of a module, interface or program
- Actual parameter to a module, interface, program or class
- Relational operator with unambiguous comparison
- Inside a cast

~~Two functions cannot have the same arguments and different return types.~~ For example, suppose there is a structure type float:

LRM 265

```

typedef struct {
    bit sign;
    bit [3:0] exponent;
    bit [10:0] mantissa;
} float;

```

The + operator can be applied to this structure by invoking a function as indicated in the overloading declarations below:

```
bind + function float faddif(int, float);
bind + function float faddfi(float, int);
bind + function float faddrf(real, float);
bind + function float faddrf(shortreal, float);
bind + function float faddfr(float, real);
bind + function float faddfr(float, shortreal);
bind + function float faddff(float, float);
bind + function float fcopyf(float); // unary +
bind + function float fcopyi(int); // unary +
bind + function float fcopyr(real); // unary +
bind + function float fcopyr(shortreal); // unary +

float A, B, C, D;
assign A = B + C; //equivalent to A = faddff(B, C);
assign D = A + 1.0; //equivalent to A = faddfr(A, 1.0);
```

The overloading declaration links the + operator to each function prototype according to the equivalent argument types in the overloaded expression, which normally must match exactly. The exception is if the actual argument is an **integer integral** type and there is only one prototype with a corresponding **integer integral** argument, the actual is implicitly cast to the type in the prototype.

LRM 265

Note that the function prototype does not need to match the actual function declaration exactly. If it does not, then the normal implicit casting rules apply when calling the function. For example the `fcopyi` function can be defined with an `int` argument:

```
function float fcopyi (int i);
    float o;
    o.sign = i[31];
    o.exponent = 0;
    o.mantissa = 0;
    ...
    return o;
endfunction
```

Overloading the assignment operator also serves to overload implicit assignments or casting. Here these are using the same functions as the unary +.

```
bind = function float fcopyi(int); // cast int to float
bind = function float fcopyr(real); // cast real to float
bind = function float fcopyr(shortreal); // cast shortreal to float
```

The operators that can be overloaded are the arithmetic operators, the relational operators and assignment. Note that the assignment operator from a float to a float cannot be overloaded here because it is already legal. Similarly, equality and inequality between floats cannot be overloaded.

No format can be assumed for 0 or 1, so the user cannot rely on subtraction to give equality, or on addition to give increment. Similarly no format can be assumed for positive or negative, so comparison must be explicitly coded.

An assignment operator such as += is automatically built from both the + and = operators successively, where the = has its normal meaning. For example

```
float A, B;
bind + function float faddff(float, float);
always @(posedge clock) A += B; // equivalent to A = A + B
```

The scope and visibility of the overload declaration follows the same search rules as a data declaration. The overload declaration must be defined before use in a scope which is visible. The function bound by the overload declaration uses the same scope search rules as a function enable from the scope where the operator is

invoked.

7.18 Streaming operators (pack / unpack)

LRM 109

The bit-stream casting described in Section 3.16 is most useful when the conversion operation can be easily expressed using only a type cast, and the specific ordering of the bit-stream is not important. Sometimes, however, a stream that matches a particular machine organization is required. The streaming operators perform packing of bit-stream types (see Section 3.16) into a sequence of bits in a user-specified order. When used in the left-hand-side, the streaming operators perform the reverse operation, unpack a stream of bits into one or more variables. If the data being packed contains any 4-state types, the result of a pack operation is a 4-state stream; otherwise, the result of a pack is a 2-state stream. Unpacking a 4-state stream into a 2-state type is done by a cast to a 2-state variable, and vice-versa.

The syntax of the bit-stream concatenation is:

```
streaming_expression ::= { stream_operator [ slice_size ] stream_concatenation } // from Annex A.8.1
stream_operator ::= >> | <<
slice_size ::= ps_type_identifier | constant_expression
stream_concatenation ::= { stream_expression { , stream_expression } }
stream_expression ::=
    expression
    | array_identifier [ with [ array_range_expression ] ]
array_range_expression ::=
    expression
    | expression : expression
    | expression +: expression
    | expression -: expression
primary ::=
    ...
    | streaming_expression
```

LRM 249

Syntax 7-4—streaming concatenation syntax (excerpt from Annex A)

The stream-operator determines the order in which data is streamed: >> causes data to be streamed in left-to-right order, while << causes data to be streamed in right-to-left order. If a slice-size is specified then the data to be streamed is first broken up into slices with the specified number of bits, and then the slices are streamed in the specified order. If a slice-size is not specified, the default is 1 (or bit). If, as a result of slicing, the last slice is less than the slice width then no padding is added.

For example:

```
int j = { "A", "B", "C", "D" };
{ >> {j}} // generates stream "A" "B" "C" "D"
{ << byte {j}} // generates stream "D" "C" "B" "A" (little endian)
{ << 16 {j}} // generates stream "C" "D" "A" "B"
{ << { 8'b0011_0101 }} // generates stream 'b1010_1100 (bit reverse)
{ << 4 { 6'b11_0101 }} // generates stream 'b0101_11
{ >> 4 { 6'b11_0101 }} // generates stream 'b1101_01 (same)
{ << 2 { { << { 4'b1101 } } }} // generates stream 'b1110
```

LRM 269

The streaming operators operate directly on integral types and streams. When applied to unpacked aggregate types, such as unpacked arrays, unpacked structures, or classes, they recursively traverse the data in depth-first order until reaching an integral type. A multi-dimensional packed array is thus treated as a single integral type,

whereas an unpacked array of packed items causes each packed item to be streamed individually. The streaming operators can only process bit-stream types; any other types shall generate an error.

The result of the pack operation can be assigned directly to any bit-stream type variable. If the left-hand side represents a fixed-size variable and the stream is larger than the variable, an error will be generated. If the variable is larger than the stream, the stream is left-justified and zero-filled on the right. If the left-hand side represents a dynamic-size variable, such as a queue or dynamic array, the variable is resized to accommodate the entire stream. If after resizing, the variable is larger than the stream, the stream is left-justified and zero-filled on the right. The stream is not an integral value; to participate in an expression, a cast is required.

The unpack operation accepts any bit-stream type on the right-hand side, including a stream. The right-hand side data being unpacked is allowed to have more bits than are consumed by the unpack operation. However, if more bits are needed than are provided by the right-hand side expression, an error is generated.

For example:

```
int a, b, c;
logic [10:0] up [3:0];
logic [11:1] p1, p2, p3, p4;
bit [96:1] y = {>>{ a, b, c }}; // OK: pack a, b, c
int j = {>>{ a, b, c }}; // error: j is 32 bits < 96 bits
bit [99:0] d = {>>{ a, b, c }}; // OK: b is padded with 4 bits
{>>{ a, b, c }} = 23'b1; // error: too few bits in stream
{>>{ a, b, c }} = 96'b1; // OK: unpack a = 0, b = 0, c = 1
{>>{ a, b, c }} = 100'b1; // OK: unpack as above (4 bits unread)
{ >> {p1, p2, p3, p4}} = up; // OK: unpack p1 = up[3], p2 = up[2],
// p3 = up[1], p4 = up[0]
```

LRM 222

7.18.1 Streaming dynamically-sized data

If the unpack operation includes unbounded dynamically-sized types, the process is greedy (as in a cast): the first dynamically-sized item is resized to accept all the available data (excluding subsequent fixed-sized items) in the stream; any remaining dynamically-sized items are left empty. This mechanism is sufficient to unpack a packet-sized stream that contains only one dynamically-sized data item. However, when the stream contains multiple variable-sized data packets, or each data packet contains more than one variable-sized data item, or the size of the data to be unpacked is stored in the middle of the stream, this mechanism can become cumbersome and error-prone. To overcome these problems, the unpack operation allows a **with** expression to explicitly specify the extent of a variable-sized field within the unpack operation.

The syntax of the **with** expression is:

```
stream_expression ::= // from Annex A.8.1
    expression
    | array_identifier [ with [ array_range_expression ] ]
array_range_expression ::=
    expression
    | expression : expression
    | expression +: expression
    | expression -: expression
```

Syntax 7-5—*with* expression syntax (excerpt from Annex A)

The array range expression within the **with** construct must be of integral type and evaluate to values that lie within the bounds of a fixed-size array, or to positive values for dynamic arrays or queues. The array identifier can be any one-dimensional unpacked array (including a queue). The expression within the **with** is evaluated immediately before its corresponding array is streamed (i.e., packed or unpacked). Thus, the expression can

refer to data that is unpacked by the same operator but before the array. If the expression refers to variables that are unpacked after the corresponding array (to the right of the array) then the expression is evaluated using the previous values of the variables.

When used within the context of an unpack operation and the array-identifier designates a variable-sized array, the array shall be resized to accommodate the range expression. If the array-identifier designates a fixed-sized array and the range expression evaluates to a range outside the extent of the array, only the range that lies within the array is unpacked and an error is generated. If the range expression evaluates to a range smaller than the extent of the array (fixed or variable sized), only the specified items are unpacked into the designated array locations; the remainder of the array is unmodified.

When used within the context of a pack (on the right-hand side), it behaves the same as an array slice: The specified number of array items are packed into the stream. If the range expression evaluates to a range smaller than the extent of the array, only the specified array items are streamed. If the range expression evaluates to a range greater than the extent of the array size, the entire array is streamed and the remaining items are generated using the default value (as described in Table 5-1) for the given array.

For example, the code below uses streaming operators to model a packet transfer over a byte stream that uses little-endian encoding:

```

byte stream[$]; // byte stream

class Packet
  rand int header;
  rand int len;
  rand byte payload[];
  int crc;

  constraint G { len > 1; payload.size == len ; }

  function void post_randomize; crc = payload.sum; endfunction
endclass

...
send: begin // Create random packer and transmit
  byte q[$];
  Packet p = new;
  void' (p.randomize());
  q = {<< byte{p.header, p.len, p.payload, p.crc}}; // pack
  stream = {stream, q}; // append to stream
end

...
receive: begin // Receive packet, unpack, and remove
  byte q[$];
  Packet p = new;
  {<< byte{ p.header, p.len, p.payload with [0 +: p.len], p.crc }} = stream;
  stream = stream[ $bits(p) / 8 : $ ]; // remove packet
end

```

In the example above, the pack operation could have been written as either:

```
q = {<<byte{p.header, p.len, p.payload with [0 +: p.len], p.crc}};
```

or

```
q = {<<byte{p.header, p.len, p.payload with [0 : p.len-1], p.crc}};
```

or

```
q = {<<byte{p}};
```

The result in this case would be the same since `p.len` is the size of `p.payload` as specified by the constraint.

7.19 Conditional operator

```
conditional_expression ::=                               // from Annex A.8.3
    cond_predicate ? { attribute_instance } expression : expression
cond_predicate ::=                                     // from Annex A.6.6
    expression_or_cond_pattern { && expression_or_cond_pattern }
expression_or_cond_pattern ::=
    expression | cond_pattern
cond_pattern ::= expression matches pattern
```

LRM 122

Syntax 7-6—Conditional operator syntax (excerpt from Annex A)

This section describes the traditional notation where *cond_predicate* is just a single expression. SystemVerilog also allows *cond_predicate* to perform pattern matching, and this is described in Section 8.4.

As defined in Verilog, if *cond_predicate* is true, the operator returns first *expression*, if false, it returns second *expression*. If *cond_predicate* evaluates to an ambiguous value (x or z), then both first *expression* and second *expression* shall be evaluated and their results shall be combined, bit by bit.

SystemVerilog extends the conditional operator to non **bit-level integral** types and aggregate expressions using the following rules:

LRM 228

- If both first *expression* and second *expression* are **bit-level types, or a packed aggregate** of **bit integral** type, the operation proceeds as defined.
- If first *expression* or second *expression* is **a bit-level an integral** type and the opposing expression can be implicitly cast to **a bit-level an integral** type, the cast is made and proceeds as defined.
- For all other cases, the type of first *expression* and second *expression* must be equivalent.

If *cond_predicate* evaluates to an ambiguous value, then both first *expression* and second *expression* shall be evaluated and their results shall be combined, element-by-element. If the elements match, the element is returned. If they do not match, then the default-uninitialized value for that element's type shall be returned.

7.20 Set membership

LRM 16

SystemVerilog supports singular value sets and set membership operators.

LRM 105

The syntax for the set membership operator is:

```
inside_expression ::= expression inside { open_range_list } | // from Annex A.8.3
```

LRM 263

Syntax 7-7—inside expression syntax (excerpt from Annex A)

The *expression* on the left-hand side of the **inside** operator is any singular expression.

The set-membership *open_range_list* on the right-hand side of the **inside** operator is a comma-separated list of expressions or ranges. If an expression in the list is an aggregate array, its elements are traversed by descend-

ing into the array until reaching a singular value. The members of the set are scanned until a match is found and the operation returns 1'b1. Values can be repeated, so values and value ranges can overlap. The order of evaluation of the expressions and ranges is non-deterministic.

```
int a, b, c;
if ( a inside {b, c} ) ...
int array [$] = {3,4,5};
if ( ex inside {1, 2, array} ) ... // same as { 1, 2, 3, 4, 5}
```

The **inside** operator uses the equality (==) operator on non-integral expressions to perform the comparison. If no match is found, the **inside** operator returns 1'b0. Integral expressions also use the equality operator, except that a z inside a value in the set is treated as a don't care and that bit position shall not be considered. Note that unlike comparisons performed by the **casez** statement, z values in the expression on the left-hand side are not treated as a don't-care; the don't-care is unidirectional.

```
logic [2:0] val;
while ( val inside {3'b1?1} ) ... // matches 3'b101, 3'b111, 3'b1x1, 3'b1z1
```

If no match is found, but some of the comparisons result in x, the inside operator shall return 1'bx. The return value is effectively the or reduction of all the comparisons in the set with the expression on the left-hand side.

```
wire r;
assign r=3'bz11 inside {3'b1?1, 3'b011}; // r = 1'bx
```

A range can be specified with a low and high bound enclosed by square braces [], and separated by a colon (:), as in [low_bound:high_bound]. A bound specified by \$ shall represent the lowest or highest value for the type of the expression on the left-hand side. A match is found if the expression on the left-hand side is inclusively within the range. When specifying a range, the expressions must be of a singular type for with the relation operators (<=, >=) are defined. If the bound to the left of the colon is greater than the bound to the right, the range is empty and contains no values.

For example:

```
bit ba = a inside { [16:23], [32:47] };
string I;
if ( I inside {["a rock":"hard place"]} ) ...
    // I between "a rock" and a "hard place"
```

Section 8

Procedural Statements and Control Flow

8.1 Introduction (informative)

Procedural statements are introduced by the following:

```
initial // enable this statement at the beginning of simulation and execute it only once
final // do this statement once at the end of simulation
always, always_comb, always_latch, always_ff // loop forever (see Section 9 on processes)
task // do these statements whenever the task is called
function // do these statements whenever the function is called and return a value
```

SystemVerilog has the following types of control flow within a process

- Selection, loops and jumps
- Task and function calls
- Sequential and parallel blocks
- Timing control

Verilog procedural statements are in **initial** or **always** blocks, tasks or functions. SystemVerilog adds a final block that executes at the end of simulation.

Verilog includes most of the statement types of C, except for `do...while`, `break`, `continue` and `goto`. Verilog has the **repeat** statement which C does not, and the **disable**. The use of the Verilog **disable** to carry out the functionality of `break` and `continue` requires the user to invent block names, and introduces the opportunity for error.

SystemVerilog adds C-like **break**, **continue** and **return** functionality, which do not require the use of block names.

Loops with a test at the end are sometimes useful to save duplication of the loop body. SystemVerilog adds a C-like **do...while** loop for this capability.

Verilog provides two overlapping methods for procedurally adding and removing drivers for variables: the **force/release** statements and the **assign/deassign** statements. The **force/release** statements can also be used to add or remove drivers for nets in addition to variables. A force statement targeting a variable that is currently the target of an assign shall override that assign; however, once the force is released, the assign's effect again shall be visible.

The keyword **assign** is much more commonly used for the somewhat similar, yet quite different purpose of defining permanent drivers of values to nets.

SystemVerilog **final** blocks execute in an arbitrary but deterministic sequential order. This is possible because **final** blocks are limited to the legal set of statements allowed for functions. SystemVerilog does not specify the ordering, but implementations should define rules that preserve the ordering between runs. This helps keep the output log file stable since **final** blocks are mainly used for displaying statistics.

8.2 Statements

The syntax for procedural statements is:

```

statement_or_null ::=                                     //from Annex A.6.4
    statement
    | { attribute_instance } ;
statement ::= [ block_identifier : ] { attribute_instance } statement_item
statement_item ::=
    blocking_assignment ;
    | nonblocking_assignment ;
    | procedural_continuous_assignments ;
    | procedural_continuous_assignment ;
    | case_statement
    | conditional_statement
    | inc_or_dec_expression ;
    | subroutine_call_statement
    | disable_statement
    | event_trigger
    | loop_statement
    | jump_statement
    | par_block
    | procedural_timing_control_statement
    | seq_block
    | wait_statement
    | procedural_assertion_item
    | procedural_assertion_statement
    | clocking_drive ;
    | randsequence_statement
    | scope_randomize
    | randcase_statement
    | expect_property_statement

```

LRM 240
LRM 242
LRM 248
LRM 250

LRM 39
LRM 41
LRM 66
LRM 73

LRM 113
LRM 136

LRM 173

LRM 165

Syntax 8-1—Procedural statement syntax (excerpt from Annex A)

8.3 Blocking and nonblocking assignments

```

blocking_assignment ::=                                 //from Annex A.6.2
    variable_lvalue = delay_or_event_control expression
    | hierarchical_dynamic_array_variable_identifier [ ] = dynamic_array_new
    | class_variable_identifier = class_new
    | class_variable_identifier . randomize [ ( ) ] with constraint_block
    | operator_assignment
operator_assignment ::= variable_lvalue assignment_operator expression
assignment_operator ::=
    = | += | -= | *= | /= | %= | &= | |= | ^= | <<= | >>= | <<<= | >>>=
nonblocking_assignment ::= variable_lvalue <= [ delay_or_event_control ] expression

```

LRM 248

LRM 59

LRM 117

Syntax 8-2—blocking and nonblocking assignment syntax (excerpt from Annex A)

The following assignments are allowed in both Verilog-2001 and SystemVerilog:

```
#1 r = a;
```



```

r = #1 a;
r <= #1 a;
r <= a;
@c r = a;
r = @c a;
r <= @c a;

```

SystemVerilog also allows a time unit to be specified in the assignment statement, as follows:

LRM 100

```

#1ns r = a;
r = #1ns a;
r <= #1ns a;

```

It shall be illegal to make nonblocking assignments to automatic variables.

The size of the left-hand side of an assignment forms the context for the right hand side expression. If the left-hand side is smaller than the right hand side, information can be lost, and a warning can be given.

8.4 Selection statements

```

conditional_statement ::=
    if ( cond_predicate ) statement_or_null [ else statement_or_null ]
    | unique_priority_if_statement
unique_priority_if_statement ::=
    [ unique_priority ] if ( cond_predicate ) statement_or_null
    { else if ( cond_predicate ) statement_or_null }
    [ else statement_or_null ]
unique_priority ::= unique | priority
cond_predicate ::=
    expression_or_cond_pattern { && expression_or_cond_pattern }
expression_or_cond_pattern ::=
    expression | cond_pattern
cond_pattern ::= expression matches pattern
case_statement ::=
    [ unique_priority ] case_keyword ( expression ) case_item { case_item } endcase
    | [ unique_priority ] case_keyword ( expression ) matches case_pattern_item { case_pattern_item }
    endcase
case_keyword ::= case | casez | casex
case_item ::=
    expression { , expression } : statement_or_null
    | default [ : ] statement_or_null
case_pattern_item ::=
    pattern [ && expression ] : statement_or_null
    | default [ : ] statement_or_null

```

// from Annex A.6.6

LRM 122

LRM 81

LRM 122

// from Annex A.6.7

LRM 122

Syntax 8-3—Selection statement syntax (excerpt from Annex A)

In Verilog, an **if** (*expression*) is evaluated as a boolean, so that if the result of the expression is 0 or X, the test is considered false.

SystemVerilog adds the keywords **unique** and **priority**, which can be used before an **if**. If either keyword

is used, it shall be a run-time error for no condition to match unless there is an explicit **else**. For example:

```
unique if ((a==0) || (a==1)) $display("0 or 1");
else if (a == 2) $display("2");
else if (a == 4) $display("4"); // values 3,5,6,7 cause an error

priority if (a[2:1]==0) $display("0 or 1");
else if (a[2] == 0) $display("2 or 3");
else $display("4 to 7"); //covers all other possible values, so no error
```

A **unique if** indicates that there should not be any overlap in a series of **if...else...if** conditions, i.e. they should be mutually exclusive, allowing the expressions to be evaluated in parallel. A software tool shall issue an error if it determines that more than one condition is, or can be, true. A software tool shall also issue an error if it determines that no condition is true, or it is possible that no condition is true, and the final **if** does not have a corresponding **else**.

LRM 81

A **priority if** indicates that a series of **if...else...if** conditions shall be evaluated in the order listed. In the preceding example, if the variable *a* had a value of 0, it would satisfy both the first and second conditions, requiring priority logic. A software tool shall also issue an error if it determines that no condition is true, or it is possible that no condition is true, and the final **if** does not have a corresponding **else**.

The **unique** and **priority** keywords apply to the entire series of **if...else...if** conditions. In the preceding examples it would have been illegal to insert either keyword after any of the occurrences of **else**. To nest another if statement within such a series of conditions, a **begin...end** block should be used.

In Verilog, there are three types of case statements, introduced by **case**, **casez** and **casex**. With SystemVerilog, each of these can be qualified by **priority** or **unique**. A **priority case** shall act on the first match only. A **unique case** shall **guarantee no check for overlapping case values items**, allowing the case items to be evaluated in parallel. A **unique case** shall **issue a warning message if more than one case item matches the case expression**. If the case is qualified as **priority** or **unique**, the simulator shall issue **an error** or a warning message if **an unexpected no case value is found item matches**. These warnings can be issued at either compile time or run time, as soon as it is possible to determine the illegal condition.

LRM 245

Note: by specifying **unique** or **priority**, it is not necessary to code a **default** case to trap unexpected case values. For example:

```
bit [2:0] a;
unique case(a) // values 3,5,6,7 cause a run-time error
  0,1: $display("0 or 1");
  2: $display("2");
  4: $display("4");
endcase

priority casez(a)
  2'b00?: $display("0 or 1");
  2'b0??: $display("2 or 3");
  default: $display("4 to 7");
endcase
```

The **unique** and **priority** keywords shall determine the simulation behavior. It is recommended that synthesis follow simulation behavior where possible. Attributes can also be used to determine synthesis behavior.

8.4.1 Pattern matching

LRM 122

Pattern matching provides a visual and succinct notation to compare a value against structures, tagged unions and constants, and to access their members. SystemVerilog adds pattern matching capability to **case** and **if** statements, and to conditional expressions. Before describing pattern matching in those contexts, we first describe the general concepts.

A pattern is a nesting of tagged union and structure expressions with identifiers, constant expressions, and the wildcard pattern “.*” at the leaves. For tagged union patterns, the identifier following the **tagged** keyword is a union member name. For **void** members the nested member pattern is omitted.

```

pattern ::= // from Annex A.6.7.1
    variable_identifier
    | .*
    | .constant_expression
    | tagged member_identifier [ pattern ]
    | { pattern { , pattern } }
    | { member_identifier : pattern { , member_identifier : pattern } }

```

LRM 150

Syntax 8-4—pattern syntax (excerpt from Annex A)

A pattern always occurs in a context of known type because it is matched against an expression of known type. Recursively, its nested patterns also have known type. A constant expression pattern must be of integral type. Thus a pattern can always be statically type-checked.

Each pattern introduces a new scope; the extent of this scope is described separately below for case statements, if statements and conditional expressions. Each pattern identifier is implicitly declared as a new variable within the pattern’s scope, with the unique type that it must have based on its position in the pattern. Pattern identifiers must be unique in the pattern, i.e., the same identifier cannot be used in more than one position in a single pattern.

In pattern-matching, the value *V* of an expression is always matched against a pattern. Note that static type-checking ensures that *V* and the pattern have the same type. The result of a pattern match is:

- A 1-bit determined value: 0 (false, or fail) or 1 (true, or succeed). The result cannot be x or z even if the value and pattern contain such bits.
- If the match succeeds, the pattern identifiers are bound to the corresponding members from *V*, using ordinary procedural assignment.

Each pattern is matched using the following simple recursive rule:

- An identifier pattern always succeeds (matches any value), and the identifier is bound to that value (using ordinary procedural assignment).
- The wildcard pattern “.*” always succeeds.
- A constant expression pattern succeeds if *V* is equal to its value.
- A tagged union pattern succeeds if the value has the same tag and, recursively, if the nested pattern matches the member value of the tagged union.
- A structure pattern succeeds if, recursively, each of the nested member patterns matches the corresponding member values in *V*. In structure patterns with named members, the textual order of members does not matter, and members can be omitted. Omitted members are ignored.

Conceptually, if the value *V* is seen as a flattened vector of bits, the pattern specifies which bits to match, with what values they should be matched and, if the match is successful, which bits to extract and bind to the pattern identifiers. Matching can be insensitive to x and z values, as described in the individual constructs below.

8.4.1.1 Pattern matching in case statements

LRM 122

In a pattern-matching case statement, the expression in parentheses is followed by the keyword **matches**, and the statement contains a series of “case_pattern_items”. The left-hand side of a case item, before the “:”, consists of a pattern and, optionally, the operator **&&** followed by a boolean “filter” expression. The right-hand side of a case item is a statement. Each pattern introduces a new scope, in which its pattern identifiers are

implicitly declared; this scope extends to the optional filter expression and the statement in the right-hand side of the same case item. Thus different case items can reuse pattern identifiers.

All the patterns are completely statically type-checked. The expression being tested in the pattern-matching case statement must have a known type, which is the same as the type of the pattern in each case item.

The expression in parentheses in a pattern-matching case statement shall be evaluated exactly once. Its value V shall be matched against the left-hand sides of the case items, one at a time, in the exact order given, ignoring the default case item if any. During this linear search, if a case item is selected, its statement is executed and the linear search is terminated. If no case item is selected, and a default case item is given, then its statement is executed. If no case item is selected and no default case item is given, no statement is executed.

For a case item to be selected, the value V must match the pattern (and the pattern identifiers are assigned the corresponding member values in V) and then the boolean filter expression must evaluate to true (a determined value other than 0).

Example:

```
typedef union tagged {
    void Invalid;
    int Valid;
} VInt;
...
VInt v;
...
case (v) matches
    tagged Invalid : $display ("v is Invalid");
    tagged Valid n : $display ("v is Valid with value %d", n);
endcase
```

In the case statement, if v currently has the `Invalid` tag, the first pattern is matched. Otherwise, it must have the `Valid` tag, and the second pattern is matched. The identifier n is bound to the value of the `Valid` member, and this value is displayed. It is impossible to access the integer member value (n) when the tag is `Invalid`.

Example:

```
typedef union tagged {
    struct {
        bit [4:0] reg1, reg2, regd;
    } Add;
    union tagged {
        bit [9:0] JmpU;
        struct {
            bit [1:0] cc,
            bit [9:0] addr;
        } JmpC;
    } Jmp;
} Instr;
...
Instr instr;
...
case (instr) matches
    tagged Add {r1,r2,rd} && (rd != 0): rf[rd] = rf[r1] + rf[r2];
    tagged Jmp j
        : case (j) matches
            tagged JmpU a : pc = pc + a;
            tagged JmpC {c,a}: if (rf[c]) pc = a;
        endcase
endcase
```

If `instr` holds an `Add` instruction, the first pattern is matched, and the identifiers `r1`, `r2` and `rd` are bound to the three register fields in the nested structure value. The right-hand side statement executes the instruction on the register file `rf`. It is impossible to access these register fields if the tag is `Jmp`. If `instr` holds a `Jmp` instruction, the second pattern is matched, and the identifier `j` is bound to the nested tagged union value. The inner case statement, in turn, matches this value against `JmpU` and `JmpC` patterns, and so on.

Example (same as previous example, but using wildcard and constant patterns to eliminate the `rd = 0` case; in some processors, register 0 is a special "discard" register):

```

case (instr) matches
  tagged Add {.*,.*, . 0} : ; // no op
  tagged Add {r1,r2, rd} : rf[rd] = rf[r1] + rf[r2];
  tagged Jmp j : case (j) matches
    tagged JmpU a : pc = pc + a;
    tagged JmpC {c,a} : if (rf[c]) pc = a;
  endcase
endcase

```

Example (same as previous example, but note that the first inner case statement involves only structures and constants but no tagged unions):

```

case (instr) matches
  tagged Add s: case (s) matches
    {.*,.*, . 0} : ; // no op
    {r1,r2, rd} : rf[rd] = rf[r1] + rf[r2];
  endcase
  tagged Jmp j: case (j) matches
    tagged JmpU a : pc = pc + a;
    tagged JmpC {c,a} : if (rf[c]) pc = a;
  endcase
endcase

```

Example (same as previous example, but using nested tagged union patterns):

```

case (instr) matches
  tagged Add {r1,r2,rd} && (rd != 0) : rf[rd] = rf[r1] + rf[r2];
  tagged Jmp (tagged JmpU a) : pc = pc + a;
  tagged Jmp (tagged JmpC {c,a}) : if (rf[c]) pc = a;
endcase

```

Example (same as previous example, with named structure components):

```

case (instr) matches
  tagged Add {reg2:r2,regd:rd,reg1:r1} && (rd != 0) : rf[rd] = rf[r1] + rf[r2];
  tagged Jmp (tagged JmpU a) : pc = pc + a;
  tagged Jmp (tagged JmpC {addr:a,cc:c}) : if (rf[c]) pc = a;
endcase

```

As usual, the `casez` and `casex` keywords can be used instead of `case`, with the same semantics. In other words, during pattern matching, wherever two bits are compared (whether they are tag bits or members), the `casez` form ignores z bits, and the `casex` form ignores both z and x bits.

The `priority` and `unique` qualifiers play their usual role. `priority` implies that some case item must be selected. `unique` also implies that exactly one case item will be selected, so that they can be evaluated in parallel.

8.4.1.2 Pattern matching in if statements

LRM 122

The predicate in an `if` statement can be a series of clauses separated with the `&&` operator. Each clause is either an expression (used as a boolean filter), or has the form `expression matches pattern`. The clauses repre-

sent a sequential conjunction from left to right, i.e., if any clause fails the remaining clauses are not evaluated, and all of them must succeed for the predicate to be true. Boolean expression clauses are evaluated as usual. Each pattern introduces a new scope, in which its pattern identifiers are implicitly declared; this scope extends to the remaining clauses in the predicate and to the corresponding “true” arm of the `if` statement.

In each `e` matches `p` clause, `e` and `p` must have the same known statically known type. The value of `e` is matched against the pattern `p` as described above.

Even though the pattern matching clauses always return a defined 1-bit result, the overall result can be ambiguous because of the boolean filter expressions in the predicate. The standard semantics of `if` statements hold, i.e., the first statement is executed if and only if the result is a determined value other than 0.

Example:

```
if (e matches (tagged Jmp (tagged JmpC {cc:c,addr:a})))
    ... // c and a can be used here
else
    ...
```

Example (same as previous example, illustrating a sequence of two pattern-matches with identifiers bound in the first pattern used in the second pattern).

```
if (e matches (tagged Jmp j),
    j matches (tagged JmpC {cc:c,addr:a}))
    ... // c and a can be used here
else
    ...
```

Example (same as first example, but adding a boolean expression to the sequence of clauses). The idea expressed is: “if `e` is a conditional jump instruction and the condition register is not equal to zero ...”.

```
if (e matches (tagged Jmp (tagged JmpC {cc:c,addr:a}))
    && (rf[c] != 0))
    ... // c and a can be used here
else
    ...
```

The `priority` and `unique` qualifiers play their usual role for `if` statements even if they use pattern matching.

8.4.1.3 Pattern matching in conditional expressions

LRM 122

A conditional expression (`e1 ? e2 : e3`) can also use pattern matching, i.e., the predicate `e1` can be a sequence of expressions and “expression matches pattern” clauses separated with the `&&` operator, just like the predicate of an `if` statement. The clauses represent a sequential conjunction from left to right, i.e., if any clause fails the remaining clauses are not evaluated, and all of them must succeed for the predicate to be true. Boolean expression clauses are evaluated as usual. Each pattern introduces a new scope, in which its pattern identifiers are implicitly declared; this scope extends to the remaining clauses in the predicate and to the consequent expression `e2`.

As described in the previous section, `e1` can evaluate to true, false or an ambiguous value. The semantics of the overall conditional expression are described in Section 7.18, based on these three possible outcomes for `e1`.

8.5 Loop statements

<pre> loop_statement ::= forever statement_or_null repeat (expression) statement_or_null while (expression) statement_or_null for (for_initialization ; expression ; for_step) statement_or_null do statement_or_null while (expression) ; foreach (array_identifier { [loop_variables] }) statement for_initialization ::= list_of_variable_assignments data_type list_of_variable_assignments { , data_type list_of_variable_assignments } for_step ::= for_step_assignment { , for_step_assignment } for_step_assignment ::= operator_assignment inc_or_dec_expression loop_variables ::= [index_variable_identifier] { , [index_variable_identifier] } </pre>	<p><i>// from Annex A.6.8</i></p>
--	-----------------------------------

LRM 248

LRM 100

Syntax 8-5—loop statement syntax (excerpt from Annex A)

Verilog provides **for**, **while**, **repeat** and **forever** loops. SystemVerilog enhances the Verilog **for** loop, and adds a **do...while** loop and a **foreach** loop.

8.5.1 The do...while loop

```
do statement while(condition) // as C
```

The condition can be any expression which can be treated as a boolean. It is evaluated after the statement.

8.5.2 Enhanced for loop

In Verilog, the variable used to control a **for** loop must be declared prior to the loop. If loops in two or more parallel procedures use the same loop control variable, there is a potential of one loop modifying the variable while other loops are still using it.

SystemVerilog adds the ability to declare the **for** loop control variable within the **for** loop. This creates a local variable within the loop. Other parallel loops cannot inadvertently affect the loop control variable. For example:

```

module foo;

    initial begin
        for (int i = 0; i <= 255; i++)
            ...
    end

    initial begin
        loop2: for (int i = 15; i >= 0; i--)
            ...
    end
endmodule

```

The local variable declared within a `for` loop is equivalent to declaring an automatic variable in an unnamed block.

Verilog only permits a single initial statement and a single step assignment within a `for` loop. SystemVerilog allows the initial declaration or assignment statement to be one or more comma-separated statements. The step assignment can also be one or more comma-separated assignment statements.

```

for ( int count = 0; count < 3; count++ )
    value = value + ((a[count]) * (count+1));

for ( int count = 0, done = 0, int j = 0; j * count < 125; j++ )
    $display("Value j = %d\n", j );

```

8.5.3 The foreach loop

LRM 100

The `foreach` construct specifies iteration over the elements of an array. Its argument is an identifier that designates any type of array (fixed-size, dynamic, or associative) followed by a list of loop variables enclosed in square brackets. Each loop variable corresponds to one of the dimensions of the array. The `foreach` construct is similar to a repeat loop that uses the array bounds to specify the repeat count instead of an expression.

Examples:

```

string words [2] = { "hello", "world" };
int prod [1:8] [1:3];

foreach( words [ j ] )
    $display( j , words[j] );    // print each index and value

foreach( prod[ k, m ] )
    prod[k][m] = k * m;        // initialize

```

The number of loop variables must match the number of dimensions of the array variable. Empty loop variables can be used to indicate no iteration over that dimension of the array, and contiguous empty loop variables towards the end can be omitted. Loop variables are automatic, read-only, and their scope is local to the loop. The type of each loop variable is implicitly declared to be consistent with the type of array index. It shall be an error for any loop variable to have the same identifier as the array.

The mapping of loop variables to array indexes is determined by the dimension cardinality, as described in Section 23.7. The `foreach` arranges for higher cardinality indexes to change more rapidly.

```

//      1 2 3          3 4          1 2  -> Dimension numbers
int A [2][3][4];    bit [3:0][2:1] B [5:1][4];

foreach( A [ i, j, k ] ) ...
foreach( B [ q, r, , s ] ) ...

```

The first `foreach` causes `i` to iterate from 0 to 1, `j` from 0 to 2, and `k` from 0 to 3. The second `foreach` causes `q` to iterate from 5 to 1, `r` from 0 to 3, and `s` from 2 to 1 (iteration over the 3rd index is skipped).

Multiple loop variables correspond to nested loops that iterate over the given indexes. The nesting of the loops is determined by the dimension cardinality; outer loops correspond to lower cardinality indexes. In the first example above, the outermost loop iterates over `i` and the innermost loop iterates over `k`.

When loop variables are used in expressions other than as indexes to the designated array, they are auto-cast into a type consistent with the type of index. For fixed-size and dynamic arrays the auto-cast type is `int`. For associative arrays indexed by a specific index type, the auto-cast type is the same as the index type. For associative arrays indexed by a wildcard index (`*`), the auto-cast type is `unsigned longint`. To use different types, an explicit cast can be used.

8.6 Jump statements

<pre> jump_statement ::= return [expression] ; break ; continue ; </pre>	<i>//from Annex A.6.5</i>
---	---------------------------

Syntax 8-6—Jump statement syntax (excerpt from Annex A)

SystemVerilog adds the C jump statements **break**, **continue** and **return**.

```

break    // out of loop as C
continue // skip to end of loop as C
return expression // exit from a function
return    // exit from a task or void function

```

The **continue** and **break** statements can only be used in a loop. The **continue** statement jumps to the end of the loop and executes the loop control if present. The **break** statement jumps out of the loop. The **continue** and **break** statements cannot be used inside a **fork...join** block to control a loop outside the **fork...join** block.

The **return** statement can only be used in a task or function. In a function returning a value, the return must have an expression of the correct type.

Note that SystemVerilog does not include the C **goto** statement.

8.7 Final blocks

The **final** block is like an **initial** block, defining a procedural block of statements, except that it occurs at the end of simulation time and executes without delays. A **final** block is typically used to display statistical information about the simulation.

<pre> final_construct ::= final function_statement </pre>	<i>//from Annex A.6.2</i>
--	---------------------------

Syntax 8-7—Final block syntax (excerpt from Annex A)

The only statements allowed inside a **final** block are those permitted inside a function declaration. This guarantees that they execute within a single simulation cycle. Unlike an **initial** block, the **final** block does not execute as a separate process; instead, it executes in zero time, the same as a function call.

After one of the following conditions occur, all spawned processes are terminated, all pending PLI callbacks are canceled, and then the final block executes.

- The event queue is empty
- Execution of `$finish`
- Termination of all program blocks, which executes an implicit `$finish`
- PLI execution of `tf_dofinish()` or `vpi_control(vpiFinish, ...)`

```

final
  begin
    $display("Number of cycles executed %d", $time/period);
    $display("Final PC = %h", PC);
  end

```

```
end
```

Execution of `$finish`, `tf_dofinish()`, or `vpi_control(vpiFinish, ...)` from within a final block shall cause the simulation to end immediately. Final blocks can only trigger once in a simulation.

Final blocks shall execute before any PLI callbacks that indicate the end of simulation.

8.8 Named blocks and statement labels

```
seq_block ::= //from Annex A.6.3
  begin [ : block_identifier ] { block_item_declaration } { statement_or_null }
  end [ : block_identifier ]

par_block ::=
  fork [ : block_identifier ] { block_item_declaration } { statement_or_null }
  join_keyword [ : block_identifier ]

join_keyword ::= join | join_any | join_none
```

Syntax 8-8—Blocks and labels syntax (excerpt from Annex A)

Verilog allows a **begin...end**, **fork...join**, **fork...join_any** or **fork...join_none** statement block to be named. A named block is used to identify the entire statement block. A named block creates a new hierarchy scope. The block name is specified after the **begin** or **fork** keyword, preceded by a colon. For example:

```
begin : blockA    // Verilog-2001 named block
  ...
end
```

SystemVerilog allows a matching block name to be specified after the block **end**, **join**, **join_any** or **join_none** keyword, preceded by a colon. This can help document which **end** or **join**, **join_any** or **join_none** is associated with which **begin** or **fork** when there are nested blocks. A name at the end of the block is not required. It shall be an error if the name at the end is different than the block name at the beginning.

```
begin: blockB    // block name after the begin or fork
  ...
end: blockB
```

SystemVerilog allows a label to be specified before any statement, as in C. A statement label is used to identify a single statement. The label name is specified before the statement, followed by a colon.

```
labelA: statement
```

A **begin...end**, **fork...join**, **fork...join_any** or **fork...join_none** block is considered a statement, and can have a statement label before the block.

```
labelB: fork    // label before the begin or fork
  ...
join : labelB
```

It shall be illegal to have both a label before a **begin** or **fork** and a block name after the **begin** or **fork**. A label cannot appear before the **end**, **join**, **join_any** or **join_none**, as these keywords do not form a statement.

A statement with a label can be disabled using a **disable** statement. Disabling a statement shall have the same behavior as disabling a named block.

See Section 9.6 for additional discussion on `fork...join`, `fork...join_any` or `fork...join_none`.

8.9 Disable

SystemVerilog has `break` and `continue` to break out of or continue the execution of loops. The Verilog-2001 `disable` can also be used to break out of or continue a loop, but is more awkward than using `break` or `continue`. The `disable` is also allowed to disable a named block, which does not contain the `disable` statement. If the block is currently executing, this causes control to jump to the statement immediately after the block. If the block is a loop body, it acts like a `continue`. If the block is not currently executing, the `disable` has no effect.

SystemVerilog has `return` from a task, but `disable` is also supported. If `disable` is applied to a named task, all current executions of the task are disabled.

```

module ...
  always always1: begin ... t1: task1( ); ... end
  ...
endmodule

always begin
  ...
  disable u1.always1.t1; // exit task1, which was called from always1 (static)
end

```

8.10 Event control

```

delay_or_event_control ::=                                     //from Annex A.6.5
  delay_control
  | event_control
  | repeat ( expression ) event_control
delay_control ::=
  # delay_value
  | # ( mintypmax_expression )
event_control ::=
  @ hierarchical_event_identifier
  | @ ( event_expression )
  | @*
  | @ ( * )
  | @ sequence_instance
event_expression ::=
  [ edge_identifier ] expression [ iff expression ]
  | sequence_instance [ iff expression ]
  | event_expression or event_expression
  | event_expression , event_expression
edge_identifier ::= posedge | negedge                         //from Annex A.7.4

```

LRM 18

LRM 73

Syntax 8-9—Delay and event control syntax (excerpt from Annex A)

Any change in a variable or net can be detected using the `@` event control, as in Verilog. If the expression evaluates to a result of more than one bit, a change on any of the bits of the result (including an x to z change) shall trigger the event control.

SystemVerilog adds an **iff** qualifier to the **@** event control.

```
module latch (output logic [31:0] y, input [31:0] a, input enable);
  always @(a iff enable == 1)
    y <= a; //latch is in transparent mode
endmodule
```

The event expression only triggers if the expression after the **iff** is true, in this case when `enable` is equal to 1. Note that such an expression is evaluated when `a` changes, and not when `enable` changes. Also note that **iff** has precedence over **or**. This can be made clearer by the use of parentheses.

If a variable is not of a 4-state type, then **posedge** and **negedge** refer to transitions from 0 and to 0, respectively.

If the expression denotes a clocking-block **input** or **inout** (see Section 15), the event control operator uses the synchronous values, that is, the values sampled by the clocking event. The expression can also denote a clocking-block name (with no edge qualifier) to be triggered by the clocking event.

LRM 137

A variable used with the event control can be any one of the integral data types (see Section 3.3.1) or string. The variable can be either a simple variable or a **ref** argument (variable passed by reference); it can be a member of an array, associative-array, or object (class instance) of the aforementioned types.

LRM 112

Event expressions must return singular values. Aggregate types can be used in an expression provided the expression reduces to a singular value. The object members or aggregate elements can be any type as long as the result of the expression is a singular value.

If the event expression is a reference to a simple object handle orchandle variable, an event is created when a write to that variable is not equal to its previous value.

Non-virtual methods of an object and built-in methods or system functions for an aggregate type are allowed in event control expressions as long as the type of the return value is singular and the method is defined as a function, not a task.

Changing the value of object data members, aggregate elements, or the size of a dynamically sized array referenced by a method or function shall cause the event expression to be re-evaluated. An implementation can cause the event expression to be re-evaluated when changing the value or size even if the members are not referenced by the method or function.

```
real AOR[]; // dynamic array of reals
byte stream[$]; // queue of bytes
initial wait(AOR.size() > 0) ...; // waits for array to be allocated
initial wait($bits(stream) > 60)...; // waits for total number of bits
// in stream greater than 60
```

```
Packet p = new; // Packet 1
Packet q = new; // Packet 2
initial fork
  @(p.status); // Wait for status in Packet 1 to change
  @q; // Wait for a change to handle q
  # 10 q = p; // triggers @q.
  // @(p.status) now waits for status in Packet 2 to change,
  // if not already different from Packet 1
join
```

8.10.1 Sequence events

LRM 73

A sequence instance can be used in event expressions to control the execution of procedural statements based on the successful completion of the sequence. This allows the endpoint of a named sequence to trigger multiple actions in other processes. Syntax 17-2 describes the syntax for declaring sequence instances and sequence

expressions. A sequence instance can be used directly in an event expression, as shown in Syntax 8-9.

When a sequence instance is specified in an event expression, the process executing the event control shall block until the given sequence reaches its end-point, that is, the sequence succeeds non-vacuously. A sequence reaches its end point whenever there is a match for the entire sequence expression. A process resumes execution following the Observe region in which the end point is detected.

An example of using a sequence as an event control is shown below.

```
sequence abc;
@(posedge clk) a ##1 b ##1 c;
endsequence

program test;
  initial begin
    @ abc $display( "Saw a-b-c" );
    L1 : ...
  end
endprogram
```

In the example above, when the named sequence `abc` reaches its end point, the initial block in the program block `test` is unblocked, which then displays the string ‘Saw a-b-c’ and continues execution with the statement labeled `L1`. In this case, the end of the sequence acts as the trigger to unblock the event.

A sequence used in an event control is instantiated (as if by an assert property statement); the event control is used to synchronize to the end of the sequence, regardless of its start-time. Arguments to these sequences shall be static; automatic variables used as sequence arguments shall result in an error.

8.11 Level-sensitive sequence controls

LRM 73

The execution of procedural code can be delayed until a sequence termination status is true. This is accomplished using the level-sensitive `wait` statement in conjunction with the built-in method that returns the current end status of a named sequence: `triggered`.

The triggered sequence method evaluates to true if the given sequence has reached its end point at that particular point in time (in the current time-step), and false otherwise. The triggered status of a sequence is set during the Observe region and persists through the remainder of the time-step (i.e., until simulation time advances).

For example:

```
sequence abc;
@(posedge clk) a ##1 b ##1 c;
endsequence

sequence de;
@(negedge clk) d ##[2:5] e;
endsequence

program check;
  initial begin
    wait( abc.triggered || de.triggered );
    if( abc.triggered )
      $display( "abc succeeded" );
    if( de.triggered )
      $display( "de succeeded" );
    L2 : ...
  end
endprogram
```

In the above example, the `initial` block in program `check` waits for the end point (success) of either sequence `abc` or sequence `de`. When either condition evaluates to true the `wait` statement unblocks the process, which displays the sequences that caused the process to unblock and then continues to execute the statement labeled `L2`.

8.12 Procedural assign and deassign removal

SystemVerilog currently supports the procedural `assign` and `deassign` statements. However, these statements might be removed from future versions of the language. See Section 26.3.

Section 9 Processes

9.1 Introduction (informative)

Verilog-2001 has **always** and **initial** blocks which define static processes.

In an **always** block which is used to model combinational logic, forgetting an **else** leads to an unintended latch. To avoid this mistake, SystemVerilog adds specialized **always_comb** and **always_latch** blocks, which indicate design intent to simulation, synthesis and formal verification tools. SystemVerilog also adds an **always_ff** block to indicate sequential logic.

In systems modeling, one of the key limitations of Verilog is the inability to create processes dynamically, as happens in an operating system. Verilog has the **fork...join** construct, but this still imposes a static limit.

SystemVerilog has both static processes, introduced by **always**, **initial** or **fork**, and dynamic processes, introduced by built-in **fork...join_any** and **fork...join_none**.

SystemVerilog creates a thread of execution for each **initial** or **always** block, for each parallel statement in a **fork...join** block and for each dynamic process. Each continuous assignment can also be considered its own thread.

SystemVerilog 3.1 adds dynamic processes by enhancing the **fork...join** construct in a way that is more natural to Verilog users. SystemVerilog 3.1 also introduces dynamic process control constructs that can terminate or wait for processes using their dynamic, parent-child relationship. These are **wait fork** and **disable fork**.

9.2 Combinational logic

SystemVerilog provides a special **always_comb** procedure for modeling combinational logic behavior. For example:

```
always_comb
    a = b & c;

always_comb
    d <= #1ns b & c;
```

The **always_comb** procedure provides functionality that is different than a normal always procedure:

- There is an inferred sensitivity list that includes the expressions defined in Section 9.2.1. LRM 11
- The variables written on the left-hand side of assignments shall not be written to by any other process.
- The procedure is automatically triggered once at time zero, after all **initial** and **always** blocks have been started, so that the outputs of the procedure are consistent with the inputs.

The SystemVerilog **always_comb** procedure differs from the Verilog-2001 **always @*** in the following ways:

- **always_comb** automatically executes once at time zero, whereas **always @*** waits until a change occurs on a signal in the inferred sensitivity list.
- **always_comb** is sensitive to changes within the contents of a function, whereas **always @*** is only sensitive to changes to the arguments of a function.
- Variables on the left-hand side of assignments within an **always_comb** procedure, including variables from the contents of a called function, shall not be written to by any other processes, whereas **always @*** permits multiple processes to write to the same variable. LRM 123

- Statements in an `always_comb` shall not include those that block, have blocking timing or event controls, or fork...join statements. LRM 123

Software tools can perform additional checks to warn if the behavior within an `always_comb` procedure does not represent combinational logic, such as if latched behavior can be inferred.

9.2.1 Implicit `always_comb` sensitivities LRM 11

The expansion of longest static prefix “P” is defined to be:

- P itself if the P is not a memory or indexing select or if P is a legal word or bit select.
- if P is a memory or indexing select, the expansion is every possible legal memory word select with a static prefix that matches P.

The implicit sensitivity list of an `always_comb` includes the expansions of the longest static prefix of each variable or select expression that is read within the block or within any function called within the block with the following exceptions:

- any expansion of a variable declared within the block or within any function called within the block.
- any expression that is also written within the block or within any function called within the block.

9.3 Latched logic

SystemVerilog also provides a special `always_latch` procedure for modeling latched logic behavior. For example:

```
always_latch
  if(ck) q <= d;
```

The `always_latch` procedure determines its sensitivity and executes identically to the `always_comb` procedure. Software tools can perform additional checks to warn if the behavior within an `always_latch` procedure does not represent latched logic.

9.4 Sequential logic

The SystemVerilog `always_ff` procedure can be used to model synthesizable sequential logic behavior. For example:

```
always_ff @(posedge clock iff reset == 0 or posedge reset) begin
  r1 <= reset ? 0 : r2 + 1;
  ...
end
```

The `always_ff` block imposes the restriction that it contains one and only one event control and no blocking timing controls. Variables on the left-hand side of assignments within an `always_ff` procedure, including variables from the contents of a called function, shall not be written to by any other process. Software tools can perform additional checks to warn if the behavior within an `always_ff` procedure does not represent sequential logic. LRM 123

9.5 Continuous assignments

In Verilog, continuous assignments can only drive nets, and not variables.

SystemVerilog removes this restriction, and permits continuous assignments to drive nets any type of variable. Nets can be driven by multiple continuous assignments, or a mixture of primitives and continuous assign-

ments. Variables can only be driven by one continuous assignment or one primitive output. It shall be an error for a variable driven by a continuous assignment or primitive output to have an initializer in the declaration or any procedural assignment. See also Section 5.6.

9.6 fork...join

The **fork...join** construct enables the creation of concurrent processes from each of its parallel statements.

The syntax to declare a **fork...join** block is:

```

par_block ::=
    fork [ : block_identifier ] { block_item_declaration } { statement_or_null }
    join_keyword [ : block_identifier ]
join_keyword ::= join | join_any | join_none
    
```

// from Annex A.6.3

Syntax 9-1—Fork...join block syntax (excerpt from Annex A)

One or more statements can be specified, each statement shall execute as a concurrent process.

A Verilog **fork...join** block always causes the process executing the fork statement to block until the termination of all forked processes. With the addition of the **join_any** and **join_none** keywords, SystemVerilog provides three choices for specifying when the parent (forking) process resumes execution.

Table 9-1: fork...join control options

Option	Description
join	The parent process blocks until all the processes spawned by this fork complete. .
join_any	The parent process blocks until any one of the processes spawned by this fork complete.
join_none	The parent process continues to execute concurrently with all the processes spawned by the fork. The spawned processes do not start executing until the parent thread executes a blocking statement.

When defining a **fork...join** block, encapsulating the entire fork within a **begin...end** block causes the entire block to execute as a single process, with each statement executing sequentially.

```

fork
  begin
    statement1;    // one process with 2 statements
    statement2;
  end
join
    
```

In the following example, two processes are forked, the first one waits for 20ns and the second waits for the named event `eventA` to be triggered. Because the **join** keyword is specified, the parent process shall block until the two processes complete; That is, until 20ns have elapsed and `eventA` has been triggered.

```

fork
  begin
    $display( "First Block\n" );
    # 20ns;
  end
  begin
    
```

```

        $display( "Second Block\n" );
        @eventA;
    end
join

```

A **return** statement within the context of a **fork...join** statement is illegal and shall result in a compilation error. For example:

```

task wait_20;
    fork
        # 20;
        return ;    // Illegal: cannot return; task lives in another process
    join_none
endtask

```

Automatic variables declared in the scope of the **fork...join** block shall be initialized to the initialization value whenever execution enters their scope, and before any processes are spawned. These variables are useful in processes spawned by looping constructs to store unique, per-iteration data. For example:

LRM 67

```

initial
    for( int j = 1; j <= 3; ++j )
        fork
            automatic int k = j; // local copy, k, for each value of j
            #k $write( "%0d", k );
            begin
                automatic int m = j; // the value of m is undetermined
                ...
            end
        join_none

```

The example above generates the output 123.

9.7 Process execution threads

SystemVerilog creates a thread of execution for:

- Each **initial** block
- Each **always** block
- Each parallel statement in a **fork...join** (or **join_any** or **join_none**) statement group
- Each dynamic process

Each continuous assignment can also be considered its own thread.

9.8 Process control

SystemVerilog provides constructs that allow one process to terminate or wait for the completion of other processes. The **wait fork** construct waits for the completion of processes. The **disable fork** construct stops the execution of processes.

9.8.1 Wait fork

The **wait fork** statement is used to ensure that all child processes (processes created by the calling process) have completed their execution.

The syntax for **wait fork** is:

```
wait fork ; // from Annex A.6.5
```

Specifying **wait fork** causes the calling process to block until all its sub-processes have completed.

Verilog terminates a simulation run when there is no further activity of any kind. SystemVerilog adds the ability to automatically terminate the simulation when all its program blocks finish executing (i.e, they reach the end of their execute block), regardless of the status of any child processes (see Section 16.6). The **wait fork** statement allows a program block to wait for the completion of all its concurrent threads before exiting.

In the following example, in the task `do_test`, the first two processes are spawned and the task blocks until one of the two processes completes (either `exec1`, or `exec2`). Next, two more processes are spawned in the background. The **wait fork** statement shall ensure that the task `do_test` waits for all four spawned processes to complete before returning to its caller.

```
task do_test;  
  fork  
    exec1();  
    exec2();  
  join_any  
  fork  
    exec3();  
    exec4();  
  join_none  
  wait fork;          // block until exec1 ... exec4 complete  
endtask
```

9.8.2 Disable fork

The **disable fork** statement terminates all active descendants (sub-processes) of the calling process.

The syntax for **disable fork** is:

```
disable fork ; // from Annex A.6.5
```

The **disable fork** statement terminates all descendants of the calling process, as well as the descendants of the process' descendants, that is, if any of the child processes have descendants of their own, the **disable fork** statement shall terminate them as well.

In the example below, the task `get_first` spawns three versions of a task that wait for a particular device (1, 7, or 13). The task `wait_device` waits for a particular device to become ready and then returns the device's address. When the first device becomes available, the `get_first` task shall resume execution and proceed to kill the outstanding `wait_device` processes.

```
task get_first( output int adr );  
  fork  
    wait_device( 1, adr );  
    wait_device( 7, adr );  
    wait_device( 13, adr );  
  join_any  
  disable fork;  
endtask
```

Verilog supports the **disable** construct, which terminate a process when applied to the named block being executed by the process. The **disable fork** statement differs from **disable** in that **disable fork** considers the dynamic parent-child relationship of the processes, whereas **disable** uses the static, syntactical information of the disabled block. Thus, **disable** shall end all processes executing a particular block, whether the processes were forked by the calling thread or not, while **disable fork** shall end only those processes that

were spawned by the calling thread.

9.9 Fine-grain process control

LRM 24

A process is a built-in class that allows one process to access and control another process once it has started. Users can declare variables of type `process` and safely pass them through tasks or incorporate them into other objects. The prototype for the process class is:

```
class process;
    enum state { FINISHED, RUNNING, WAITING, SUSPENDED, KILLED };

    static function process self();
    function state status();
    task kill();
    task await();
    task suspend();
    task resume();
endclass
```

Objects of type `process` are created internally when processes are spawned. Users cannot create objects of type `process`; attempts to call `new` shall not create a new process, and instead result in an error. The process class cannot be extended. Attempts to extend it shall result in a compilation error. Objects of type `process` are unique; they become available for reuse once the underlying process terminates and all references to the object are discarded.

The `self()` function returns a handle to the current process, that is, a handle to the process making the call.

The `status()` function returns the process status, as defined by the state enumeration:

- **FINISHED** Process terminated normally.
- **RUNNING** Process is currently running (not in a blocking statement).
- **WAITING** Process is waiting in a blocking statement.
- **SUSPENDED** Process is stopped awaiting a resume.
- **KILLED** Process was forcibly killed (via `kill` or `disable`).

The `kill()` task terminates the given process and all its sub-processes, that is, processes spawned using `fork` statements by the process being killed. If the process to be terminated is not blocked waiting on some other condition, such as an event, `wait` expression, or a delay then the process shall be terminated at some unspecified time in the current time step.

The `await()` task allows one process to wait for the completion of another process. It shall be an error to call this task on the current process, i.e., a process cannot wait for its own completion.

The `suspend()` task allows a process to suspend either its own execution or that of another process. If the process to be suspended is not blocked waiting on some other condition, such as an event, `wait` expression, or a delay then the process shall be suspended at some unspecified time in the current time step. Calling this method more than once, on the same (suspended) process, has no effect.

The `resume()` task restarts a previously suspended process. Calling `resume` on a process that was suspended while blocked on another condition shall re-sensitize the process to the event expression, or wait for the wait condition to become true, or for the delay to expire. If the wait condition is now true or the original delay has transpired, the process is scheduled onto the Active or Reactive region, so as to continue its execution in the current time step. Calling `resume` on a process that suspends itself causes the process to continue to execute at the statement following the call to `suspend`.

The example below starts an arbitrary number of processes, as specified by the task argument N. Next, the task waits for the last process to start executing, and then waits for the first process to terminate. At that point the parent process forcibly terminates all forked processes that have not completed yet.

```

task do_n_way( int N );
  process job[1:N];

  for ( int j = 1; j <= N; j++ )
    fork
      automatic int k = j;
      begin job[j] = process::self(); ... ; end
    join_none

  for( int j = 1; j <= N; j++ ) // wait for all processes to start
    wait( job[j] != null );

  job[1].await(); // wait for first process to finish

  for ( int k = 1; k <= N; k++ ) begin
    if ( job[k].status != process::FINISHED )
      job[k].kill();
  end
endtask

```

LRM 106

Section 10

Tasks and Functions

10.1 Introduction (informative)

Verilog-2001 has static and automatic tasks and functions. Static tasks and functions share the same storage space for all calls to the tasks or function within a module instance. Automatic tasks and function allocate unique, stacked storage for each instance.

SystemVerilog adds the ability to declare automatic variables within static tasks and functions, and static variables within automatic tasks and functions.

SystemVerilog also adds:

- More capabilities for declaring task and function ports
- Function output and inout ports
- Void functions
- Multiple statements in a task or function without requiring a **begin...end** or **fork...join** block
- Returning from a task or function before reaching the end of the task or function
- Passing arguments by reference instead of by value
- Passing argument values by name instead of by position
- Default argument values
- Importing and exporting functions through the Direct Programming Interface (DPI)

10.2 Tasks

```

task_body_declaration ::= // from Annex A.2.7
    [ interface_identifier . | class_scope ] task_identifier ;
    { tf_item_declaration }
    { statement_or_null }
    endtask [ : task_identifier ]
| [ interface_identifier . | class_scope ] task_identifier ( task_port_list [ tf_port_list ] ) ;
    { block_item_declaration }
    { statement_or_null }
    endtask [ : task_identifier ]

task_declaration ::= task [ lifetime ] task_body_declaration

tf_item_declaration ::=
    block_item_declaration
    | tf_port_declaration

tf_port_list ::=
    tf_port_item { , tf_port_item }

tf_port_item ::=
    { attribute_instance } tf_input_declaration
    | { attribute_instance } tf_output_declaration
    | { attribute_instance } tf_inout_declaration
    | { attribute_instance } tf_ref_declaration
    | { attribute_instance } [ signing ] { packed_dimension } list_of_tf_variable_identifiers
    | { attribute_instance } data_type list_of_tf_variable_identifiers

tf_port_item ::=
    { attribute_instance }
    [ tf_port_direction ] data_type_or_implicit
    port_identifier variable_dimension [ = expression ]

tf_port_direction ::= port_direction | const ref

tf_port_declaration ::=
    { attribute_instance } tf_port_direction data_type_or_implicit list_of_tf_variable_identifiers ;

lifetime ::= static | automatic // from Annex A.2.1

signing ::= signed | unsigned // from Annex A.2.1

data_type_or_implicit ::=
    data_type
    | [ signing ] { packed_dimension }

```

LRM 242
LRM 243

LRM 40
LRM 45

Syntax 10-1—Task syntax (excerpt from Annex A)

A Verilog task declaration either has the formal arguments in parentheses (like ANSI C) or in declarations and directions.

```

task mytask1 (output int x, input logic y);
    ...
endtask

task mytask2;
    output x;
    input y;
    int x;

```

```

    logic y;
    ...
endtask

```

Each formal argument has one of the following directions:

```

input    // copy value in at beginning
output  // copy value out at end
inout   // copy in at beginning and out at end
ref     // pass reference (see Section 10.4.2)

```

With SystemVerilog, there is a default direction of **input** if no direction has been specified. Once a direction is given, subsequent formals default to the same direction. In the following example, the formal arguments *a* and *b* default to inputs, and *u* and *v* are both outputs.

```

task mytask3(a, b, output logic [15:0] u, v);
    ...
endtask

```

Each formal argument also has a data type which can be explicitly declared or can inherit a default type. The task argument default type in SystemVerilog is **logic**.

SystemVerilog allows an array to be specified as a formal argument to a task. For example:

```

// the resultant declaration of b is input [3:0][7:0] b[3:0]
task mytask4(input [3:0][7:0] a, b[3:0], output [3:0][7:0] y[1:0]);
    ...
endtask

```

Verilog-2001 allows tasks to be declared as **automatic**, so that all formal arguments and local variables are stored on the stack. SystemVerilog extends this capability by allowing specific formal arguments and local variables to be declared as **automatic** within a static task, or by declaring specific formal arguments and local variables as **static** within an automatic task.

With SystemVerilog, multiple statements can be written between the task declaration and **endtask**, which means that the **begin ... end** can be omitted. If **begin ... end** is omitted, statements are executed sequentially, the same as if they were enclosed in a **begin ... end** group. It shall also be legal to have no statements at all.

In Verilog, a task exits when the **endtask** is reached. With SystemVerilog, the **return** statement can be used to exit the task before the **endtask** keyword.

10.3 Functions

<pre>function_data_type⁶ ::= //from Annex A.2.6 data_type_common_item void function_body_declaration ::= [signing] [type_or_dimensions] [interface_identifier . class_scope] function_identifier ; { tf_item_declaration } { function_statement_or_null } endfunction [: function_identifier] [signing] [type_or_dimensions] [interface_identifier . class_scope] function_identifier ([tf_port_list]); { block_item_declaration } { function_statement_or_null } endfunction [: function_identifier] function_declaration ::= function [lifetime] function_body_declaration type_or_dimensions ::= packed_dimension { packed_dimension } function_data_type lifetime ::= static automatic signing ::= signed unsigned</pre>	<p>LRM 226 LRM 249</p> <p>LRM 138</p> <p>LRM 40</p> <p>//from Annex A.2.1 Annex A.2.1.3 //from Annex A.2.2.1</p>
---	--

Syntax 10-2—Function syntax (excerpt from Annex A)

A Verilog function declaration either has the formal arguments in parentheses (like ANSI C) or in declarations and directions:

```
function logic [15:0] myfunc1(int x, int y);
...
endfunction

function logic [15:0] myfunc2;
    input int x;
    input int y;
...
endfunction
```

SystemVerilog extends Verilog functions to allow the same formal arguments as tasks. Function argument directions are:

```
input    // copy value in at beginning
output  // copy value out at end
inout   // copy in at beginning and out at end
ref     // pass reference (see Section 10.4.2)
```

Function declarations default to the formal direction **input** if no direction has been specified. Once a direction is given, subsequent formals default to the same direction. In the following example, the formal arguments a and b default to inputs, and u and v are both outputs:

```
function logic [15:0] myfunc3(int a, int b, output logic [15:0] u, v);
...
```

```
endfunction
```

Each formal argument has a data type which can be explicitly declared or can inherit a default type. The default type in SystemVerilog is **logic**, which is compatible with Verilog. SystemVerilog allows an array to be specified as a formal argument to a function, for example:

```
function [3:0] [7:0] myfunc4 (input [3:0] [7:0] a, b[3:0]);
    ...
endfunction
```

It shall be illegal to call a function with **output**, **inout** or **ref** arguments in an event expression, in an expression within a procedural continuous assignment, or in an expression that is not within a procedural statement. However, a **const ref** function argument shall be legal in this context (see section 10.4.2).

LRM 14

SystemVerilog allows multiple statements to be written between the function header and **endfunction**, which means that the **begin...end** can be omitted. If the **begin...end** is omitted, statements are executed sequentially, as if they were enclosed in a **begin...end** group. It is also legal to have no statements at all, in which case the function returns the current value of the implicit variable that has the same name as the function.

10.3.1 Void Return values and void functions

LRM 226

In Verilog, functions must return values. The return value is specified by assigning a value to the name of the function.

```
function [15:0] myfunc1 (input foo [7:0] x,y);
    myfunc1 = 16'hbeef x * y - 1; //return value is assigned to function name
endfunction
```

LRM 226

SystemVerilog allows functions to be declared as type **void**, which do not have a return value. For non-void functions, a value can be returned by assigning the function name to a value, as in Verilog, or by using **return** with a value. The **return** statement shall override any value assigned to the function name. When the return statement is used, non-void functions must specify an expression with the return.

```
function [15:0] myfunc2 (input foo [7:0] x,y);
    return 16'hbeef x * y - 1; //return value is specified using return
statement
endfunction
```

LRM 226

In SystemVerilog, a function return can be a structure or union. In this case, a hierarchical name used inside the function and beginning with the function name is interpreted as a member of the return value. If the function name is used outside the function, the name indicates the scope of the whole function. If the function name is used within a hierarchical name, it also indicates the scope of the whole function.

Function calls are expressions unless of type **void**, which are statements:

```
a = b + myfunc1(c, d); //call myfunc1 (defined above) as an expression

myprint(a); //call myprint (defined below) as a statement

function void myprint (int a);
    ...
endfunction
```

10.3.2 Discarding function return values

In Verilog-2001, values returned by functions must be assigned or used in an expression. Calling a function as if it has no return value can result in a warning message. SystemVerilog allows using the **void** data type to discard a function's return value, which is done by casting the function to the **void** type:

```
void' (some_function());
```

10.3.3 Restrictions on function signing

LRM 78

It shall be illegal to add signing declarations to functions that return one of the following data types:

- void
- non integer types
- unpacked structures or unions
- data types previously defined by typedef declarations

The following function declarations would be considered illegal:

```
// illegal function declaration
function signed struct { logic a; byte b;} IllegalFoo1;
...
endfunction

typedef struct { logic a; byte b; } unpackedstruct;

// illegal function declaration
function signed unpackedstruct IllegalFoo2;
...
endfunction
```

10.4 Task and function argument passing

SystemVerilog provides two means for passing arguments to functions and tasks: by value and by reference. Arguments can also be passed by name as well as by position. Task and function arguments can also be given default values, allowing the call to the task or function to not pass arguments.

10.4.1 Pass by value

Pass by value **Pass by value** is the default mechanism for passing arguments to subroutines, it is also the only one provided by Verilog-2001. This argument passing mechanism works by copying each argument into the subroutine area. If the subroutine is automatic, then the subroutine retains a local copy of the arguments in its stack. If the arguments are changed within the subroutine, the changes are not visible outside the subroutine. When the arguments are large, it can be undesirable to copy the arguments. Also, programs sometimes need to share a common piece of data that is not declared global.

LRM 226

For example, calling the function below copies 1000 bytes each time the call is made.

```
function int crc( byte packet [1000:1] );
    for( int j= 1; j <= 1000; j++ ) begin
        crc ^= packet[j];
    end
endfunction
```

LRM 100

10.4.2 Pass by reference

Arguments passed by reference are not copied into the subroutine area, rather, a reference to the original argument is passed to the subroutine. The subroutine can then access the argument data via the reference. Arguments passed by reference must be matched with equivalent data types. See Section 5.8.1, Equivalent types. No casting shall be permitted. To indicate argument passing by reference, the argument declaration is preceded by the **ref** keyword. The general syntax is:

LRM 199

LRM 111

```
subroutine( ref type argument );
```

For example, the example above can be written as:

```
function int crc( ref byte packet [1000:1] );
  for( int j= 1; j <= 1000; j++ ) begin
    crc ^= packet[j];
  end
endfunction
```

Note that in the example, no change other than addition of the **ref** keyword is needed. The compiler knows that `packet` is now addressed via a reference, but users do not need to make these references explicit either in the callee or at the point of the call. That is, the call to either version of the `crc` function remains the same:

```
byte packet1 [1000:1];
int k = crc( packet1 ); // pass by value or by reference: call is the same
```

When the argument is passed by reference, both the caller and the subroutine share the same representation of the argument, so any changes made to the argument either within the caller or the subroutine shall be visible to each other. The semantics of assignments to variables passed by reference is that changes are seen outside the subroutine immediately (before the subroutine returns). Only variables, not nets, can be passed by reference.

Arguments passed by reference must match exactly, no promotion, conversion, or auto-casting is possible when passing arguments by reference. In particular, array arguments must match their type and all dimensions exactly. Fixed-size arrays cannot be mixed with dynamic arrays and vice-versa.

Passing an argument by reference is a unique argument passing qualifier, different from **input**, **output**, or **inout**. Combining **ref** with any other directional qualifier shall be illegal. For example, the following declaration results in a compiler error:

LRM 83

```
task incr( ref input int a ); // incorrect: ref cannot be qualified
```

A **ref** argument is similar to an **inout** argument except that an **inout** argument is copied twice: once from the actual into the argument when the subroutine is called and once from the argument into the actual when the subroutine returns. Passing object handles are no exception and have similar semantics when passed as **ref** or **inout** arguments, thus, a **ref** of an object handle allows changes to the object handle (for example assigning a new object) in addition to modification of the contents of the object.

To protect arguments passed by reference from being modified by a subroutine, the **const** qualifier can be used together with **ref** to indicate that the argument, although passed by reference, is a read-only variable.

```
task show ( const ref byte [] data );
  for ( int j = 0; j < data.size ; j++ )
    $display( data[j] ); // data can be read but not written
endtask
```

When the formal argument is declared as a **const ref**, the subroutine cannot alter the variable, and an attempt to do so shall generate a compiler error.

LRM 226

10.4.3 Default argument values

To handle common cases or allow for unused arguments, SystemVerilog allows a subroutine declaration to specify a default value for each singular argument.

The syntax to declare a default argument in a subroutine is:

```
subroutine( [ direction ] [ type ] argument = default_value );
```

LRM 159

The optional *direction* can be either **input**, **inout**, or **ref** (output ports can not specify defaults).

The *default_value* is an expression. The expression is evaluated in the scope of the caller each time the subroutine is called. The elements of the expression must be visible at the scope of subroutine and, if used, at the scope of the caller. If the default_value is not used, the expression is not evaluated and need not be visible at the scope of the caller. Note that default values are only allowed with the ANSI style declaration.

When the subroutine is called, arguments with default values can be omitted from the call and the compiler shall insert their corresponding values. Unspecified (or empty) arguments can be used as placeholders for default arguments, allowing the use of non-consecutive default arguments. If an unspecified argument is used for an argument that does not have a default value, a compiler error shall be issued.

```
task read(int j = 0, int k, int data = 1 );
...
endtask;
```

This example declares a task read() with two default arguments, j and data. The task can then be called using various default arguments:

```
read( , 5 );           // is equivalent to read( 0, 5, 1 );
read( 2, 5 );         // is equivalent to read( 2, 5, 1 );
read( , 5, );        // is equivalent to read( 0, 5, 1 );
read( , 5, 7 );      // is equivalent to read( 0, 5, 7 );
read( 1, 5, 2 );     // is equivalent to read( 1, 5, 2 );
read( );             // error; k has no default value
```

10.4.4 Argument passing by name

SystemVerilog allows arguments to tasks and functions to be passed by name as well as by position. This allows specifying non-consecutive default arguments and easily specifying the argument to be passed at the call. For example:

```
function int fun( int j = 1, string s = "no" );
...
endfunction
```

The fun function can be called as follows:

```
fun( .j(2), .s("yes") ); // fun( 2, "yes" );
fun( .s("yes") );       // fun( 1, "yes" );
fun( , "yes" );         // fun( 1, "yes" );
fun( .j(2) );           // fun( 2, "no" );
fun( .s("yes"), .j(2) ); // fun( 2, "yes" );
fun( .s(), .j() );      // fun( 1, "no" );
fun( 2 );               // fun( 2, "no" );
fun( );                 // fun( 1, "no" );
```

LRM 226

If the arguments have default values, they are treated like parameters to module instances. If the arguments do not have a default, then they must be given or the compiler shall issue an error.

If both positional and named arguments are specified in a single subroutine call, then all the positional arguments must come before the named arguments. Then, using the same example as above:

```
fun( .s("yes"), 2 ); // illegal
fun( 2, .s("yes") ); // OK
```

10.4.5 Optional argument list

When a task or function specifies no arguments, the empty parenthesis, (), following the task/function name

shall be optional. This is also true for tasks or functions that require arguments, when all arguments have defaults specified.

10.5 Import and export functions

The syntax for the import and export of functions is:

```

dpi_import_export ::= // from Annex A.2.6
    import "DPI" [ dpi_function_import_property ] [ c_identifier = ] dpi_function_proto ;
  | import "DPI" [ dpi_task_import_property ] [ c_identifier = ] dpi_task_proto ;
  | export "DPI" [ c_identifier = ] function function_identifier ;
  | export "DPI" [ c_identifier = ] task task_identifier ;

dpi_import_property ::= context | pure
dpi_function_proto9,10 ::= function named_function_proto

```

LRM 261

LRM 5

LRM 17

Syntax 10-3—Import and export syntax (excerpt from Annex A)

In both **import** and **export**, *c_identifier* is the name of the foreign function (import/export), *function_identifier* is the SystemVerilog name for the same function. If *c_identifier* is not explicitly given, it shall be the same as the SystemVerilog function *function_identifier*. An error shall be generated if and only if the *c_identifier* has characters that are not valid in a C function identifier.

Several SystemVerilog functions can be mapped to the same foreign function by supplying the same *c_identifier* for several *fnames*. Note that all these SystemVerilog functions must have identical argument types, as defined in the next paragraph.

For any given *c_identifier*, all declarations, regardless of scope, must have exactly the same function signature. The function signature includes the return type, the number, order, direction and types of each and every argument. Each type includes dimensions and bounds of any arrays/array dimensions. For **import** declarations, arguments can be open arrays. Open arrays are defined in Section 27.4.6.1. The signature also includes the **pure/context** qualifiers that can be associated with an import definition.

Only one **import** or **export** declaration of a given *function_identifier* shall be permitted in any given scope. More specifically, for an **import**, the import must be the sole declaration of *function_identifier* in the given scope. For an **export**, the function must be declared in the scope where the export occurs and there must be only one export of that *function_identifier* in that scope.

For exported functions, the exported function must be declared in the same scope that contains the **export** "DPI" declaration. Only SystemVerilog functions can be exported (specifically, this excludes exporting a class method)

Note that **import** "DPI" functions declared this way can be invoked by hierarchical reference the same as any normal SystemVerilog function. Declaring a SystemVerilog function to be exported does not change the semantics or behavior of this function from the SystemVerilog perspective (i.e. there is no effect in SystemVerilog usage other than making this exported function also accessible to C callers).

Only non-void functions with no **output** or **inout** arguments can be specified as **pure**. Functions specified as pure in their corresponding SystemVerilog external declarations shall have no side effects; their results need to depend solely on the values of their input arguments. Calls to such functions can be removed by SystemVerilog compiler optimizations or replaced with the values previously computed for the same values of the input arguments.

Specifically, a pure function is assumed to not directly or indirectly (i.e., by calling other functions):

- Perform any file operations

- Read or write anything in the broadest possible meaning, including I/O, environment variables, objects from the operating system, or from the program or other processes, shared memory, sockets, etc.
- Access any persistent data, like global or static variables.

If a pure function does not obey the above restrictions, SystemVerilog compiler optimizations can lead to unexpected behavior, due to eliminated calls or incorrect results being used.

An unqualified imported function can have side effects but cannot read or modify any SystemVerilog signals other than those provided through its arguments. Unqualified imports shall not be permitted to invoke exported SystemVerilog functions.

Imported functions with the `context` qualifier can invoke exported SystemVerilog functions, can read or write to SystemVerilog signals other than those passed through their arguments, either through the use of other interfaces or as a side effect of invoking exported SystemVerilog functions. Context functions shall always implicitly be supplied a scope representing the fully qualified instance name within which the import declaration was present (i.e. an import function always runs in the instance in which the import declaration occurred). This is the same semantics as SystemVerilog functions, which also run in the scope they are defined, rather than in the scope of the caller.

Import context functions can have side effects and can use other SystemVerilog interfaces (including but not limited to VPI). However, note that declaring an import context function does not automatically make any other simulator interface available. For VPI access (or any other interface access) to be possible, the appropriate implementation-defined mechanism must still be used to enable these interface(s). Note also that DPI calls do not automatically create or provide any handles or any special environment that might be needed by those other interfaces. It shall be the user's responsibility to create, manage or otherwise manipulate the required handles/environment(s) needed by the other interfaces. The `svGetScopeName()` and related functions exist to provide a name based linkage from DPI to other interfaces. Exported functions can only be invoked if the current DPI context refers to an instance in which the named function is defined.

To access functions defined in any other scope the foreign code shall have to change DPI context appropriately. Attempting to invoke an exported SystemVerilog function from a scope in which it is not directly visible shall result in a runtime error. How such errors are handled shall be implementation dependent. If an imported function needs to invoke an exported function that is not visible from the current scope, it needs to change, via `svSetScope`, the current scope to a scope that does have visibility to the exported function. This is conceptually equivalent to making a hierarchically qualified function call in SystemVerilog. The current SystemVerilog context shall be preserved across a call to an exported function, even if current context has been modified by an application. Note that context is not defined for non-context imports and attempting to use any functionality depending on context from non-context imports can lead to unpredictable behavior.

LRM 58

Section 11

Classes

11.1 Introduction (informative)

SystemVerilog introduces an object-oriented `class` data abstraction. Classes allow objects to be dynamically created, deleted, assigned, and accessed via object handles. Object handles provide a safe pointer-like mechanism to the language. Classes offer inheritance and abstract type modeling, which brings the advantages of C function pointers with none of the type-safety problems, thus, bringing true polymorphism into Verilog.

11.2 Syntax

<pre> class_declaration ::= [virtual] class [lifetime] class_identifier [parameter_port_list] [extends class_identifier [parameter_value_assignment] [(list_of_arguments)] ; [extends class_type [(list_of_arguments)]] ; { class_item } endclass [: class_identifier] </pre>	<p>// from Annex A.1.3</p> <p>LRM 216 LRM 249 LRM 250</p>
<pre> class_item ::= { attribute_instance } class_property { attribute_instance } class_method { attribute_instance } class_constraint { attribute_instance } type_declaration { attribute_instance } class_declaration { attribute_instance } timeunits_declaration¹⁹ </pre>	<p>LRM 58</p> <p>LRM 34</p> <p>LRM 174</p> <p>LRM 65 LRM 99</p> <p>LRM 117</p> <p>LRM 117</p>
<pre> class_property ::= { property_qualifier } data_declaration const { class_item_qualifier } data_type const_identifier [= constant_expression] ; </pre>	
<pre> class_method ::= { method_qualifier } task_declaration { method_qualifier } function_declaration extern { method_qualifier } method_prototype { method_qualifier } class_constructor_declaration extern { method_qualifier } class_constructor_prototype </pre>	
<pre> class_constructor_prototype ::= function new ([tf_port_list]) ; </pre>	
<pre> class_constraint ::= constraint_prototype constraint_declaration </pre>	
<pre> class_item_qualifier⁸ ::= static protected local </pre>	
<pre> property_qualifier⁸ ::= rand randc class_item_qualifier </pre>	
<pre> method_qualifier⁸ ::= virtual class_item_qualifier </pre>	
<pre> method_prototype ::= task named_task_proto ; function named_function_proto ; </pre>	
<pre> class_constructor_declaration ::= function [class_scope] new [([tf_port_list])] ; { block_item_declaration } [super . new [(list_of_arguments)]] ; { function_statement_or_null } endfunction [: new] </pre>	

Syntax 11-1—Class syntax (excerpt from Annex A)

11.3 Overview

A *class* is a type that includes data and subroutines (functions and tasks) that operate on that data. A class's data is referred to as *class properties*, and its subroutines are called *methods*, both are members of the class. The class properties and methods, taken together, define the contents and capabilities of some kind of object.

LRM 48

For example, a packet might be an object. It might have a command field, an address, a sequence number, a time stamp, and a packet payload. In addition, there are various things that can be done with a packet: initialize the packet, set the command, read the packet's status, or check the sequence number. Each Packet is different, but as a class, packets have certain intrinsic properties that can be captured in a definition.

```

class Packet ;
  //data or class properties
  bit [3:0] command;
  bit [40:0] address;
  bit [4:0] master_id;
  integer time_requested;
  integer time_issued;
  integer status;

  // initialization
  function new();
    command = IDLE;
    address = 41'b0;
    master_id = 5'bx;
  endfunction

  // methods
  // public access entry points
  task clean();
    command = 0; address = 0; master_id = 5'bx;
  endtask

  task issue_request( int delay );
    // send request to bus
  endtask

  function integer current_status();
    current_status = status;
  endfunction
endclass

```

A common convention is to capitalize the first letter of the class name, so that it is easy to recognize class declarations.

11.4 Objects (class instance)

A class defines a data type. An object is an instance of that class. An object is used by first declaring a variable of that class type (that holds an object handle) and then creating an object of that class (using the **new** function) and assigning it to the variable.

```

Packet p; // declare a variable of class Packet
p = new; // initialize variable to a new allocated object of the class Packet

```

The variable `p` is said to hold an object handle to an object of class `Packet`.

Uninitialized object handles are set by default to the special value `null`. An uninitialized object can be detected by comparing its handle with `null`.

For example: The task `task1` below checks if the object is initialized. If it is not, it creates a new object via the `new` command.

```
class obj_example;
    ...
endclass

task task1(integer a, obj_example myexample);
    if (myexample == null) myexample = new;
endtask
```

Accessing non-static members (Section 11.8) or virtual methods (Section 11.19) via a `null` object handle is illegal. The result of an illegal access via a null object is indeterminate, and implementations can issue an error.

SystemVerilog objects are referenced using an *object handle*. There are some differences between a C pointer and a SystemVerilog object handle. C pointers give programmers a lot of latitude in how a pointer can be used. The rules governing the usage of SystemVerilog object handles are much more restrictive. A C pointer can be incremented for example, but a SystemVerilog object handle cannot. In addition to object handles, Section 3.6 introduces the `chandle` data type for use with the DPI Direct Programming Interface (see Section 27).

Table 11-1: Comparison of pointer and handle types

Operation	C pointer	SV object handle	SV chandle
Arithmetic operations (such as incrementing)	Allowed	Not allowed	Not allowed
For arbitrary data types	Allowed	Not allowed	Not allowed
Dereference when null	Error	Not allowed	Not allowed
Casting	Allowed	Limited	Not allowed
Assignment to an address of a data type	Allowed	Not allowed	Not allowed
Unreferenced objects are garbage collected	No	Yes	No
Default value	Undefined	<code>null</code>	<code>null</code>
For classes	(C++)	Allowed	Not allowed

LRM 1

11.5 Object properties

The data fields of an object can be used by qualifying class property names with an instance name. Using the earlier example, the commands for the `Packet` object `p` can be used as follows:

LRM 48

```
Packet p = new;
p.command = INIT;
p.address = $random;
packet_time = p.time_requested;
```

Any data-type can be declared as a class property, except for net types since they are incompatible with dynamically allocated data.

11.6 Object methods

An object's methods can be accessed using the same syntax used to access class properties:

LRM 48

```
Packet p = new;
status = p.current_status();
```

Note that the assignment to `status` is not:

```
status = current_status(p);
```

The focus in object-oriented programming is the object, in this case the packet, not the function call. Also, objects are self-contained, with their own methods for manipulating their own properties. So the object doesn't have to be passed as an argument to `current_status()`. A class' properties are freely and broadly available to the methods of the class, but each method only accesses the properties associated with its object, i.e., its instance.

11.7 Constructors

SystemVerilog does not require the complex memory allocation and deallocation of C++. Construction of an object is straightforward and garbage collection, as in Java, is implicit and automatic. There can be no memory leaks or other subtle behavior that is so often the bane of C++ programmers.

SystemVerilog provides a mechanism for initializing an instance at the time the object is created. When an object is created, for example

```
Packet p = new;
```

The system executes the `new` function associated with the class:

```
class Packet;
    integer command;

    function new();
        command = IDLE;
    endfunction
endclass
```

Note that `new` is now being used in two very different contexts with very different semantics. The variable declaration creates an object of class `Packet`. In the course of creating this instance, the `new` function is invoked, in which any specialized initialization required can be done. The `new` function is also called the *class constructor*.

The `new` operation is defined as a function with no return type, and like any other function, it must be non-blocking. Even though `new` does not specify a return type, the left-hand side of the assignment determines the return type.

Class properties that include an initializer in their declaration are initialized before the execution of the user-defined class constructor. Thus, initializer values can be overridden by the class constructor.

LRM 49

Every class has a default (built-in) `new` method. The default constructor first calls its parent class constructor (`super.new()`) as described in Section 11.14) and then proceeds to initialize each member of the current object to its default (or uninitialized value).

It is also possible to pass arguments to the constructor, which allows run-time customization of an object:

```
Packet p = new(STARTUP, $random, $time);
```

where the **new** initialization task in `Packet` might now look like:

```
function new(int cmd = IDLE, bit[12:0] adrs = 0, int cmd_time );
    command = cmd;
    address = adrs;
    time_requested = cmd_time;
endfunction
```

The conventions for arguments are the same as for any other procedural subroutine calls, such as the use of default arguments.

11.8 Static class properties

LRM 48

The previous examples have only declared instance class properties. Each instance of the class (i.e., each object of type `Packet`), has its own copy of each of its six variables. Sometimes only one version of a variable is required to be shared by all instances. These class properties are created using the keyword **static**. Thus, for example, in a case where all instances of a class need access to a common file descriptor:

```
class Packet ;
    static integer fileId = $fopen( "data", "r" );
```

Now, `fileID` shall be created and initialized once. Thereafter, every `Packet` object can access the file descriptor in the usual way:

```
Packet p;
c = $fgetc( p.fileID );
```

Note that static class properties can be used without creating an object of that type.

LRM 50

11.9 Static methods

Methods can be declared as **static**. A static method is subject to all the class scoping and access rules, but behaves like a regular subroutine that can be called outside the class, even with no class instantiation. A static method has no access to non-static members (class properties or methods), but it can directly access static class properties or call static methods of the same class. Access to non-static members or to the special `this` handle within the body of a static method is illegal and results in a compiler error. Static methods cannot be virtual.

LRM 48

```
class id;
    static int current = 0;
    static function int next_id();
        next_id = ++current; // OK to access static class property
    endfunction
endclass
```

A static method is different from a method with static lifetime. The former refers to the lifetime of the method within the class, while the latter refers to the lifetime of the arguments and variables within the task.

```
class TwoTasks;
    static task foo(); ... endtask // static class method with
                                // automatic variable lifetime

    task static bar(); ... endtask // non-static class method with
                                // static variable lifetime
endclass
```

By default, class methods have automatic lifetime for their arguments and variables.

11.10 This

The **this** keyword is used to unambiguously refer to class properties or methods of the current instance. The **this** keyword denotes a predefined object handle that refers to the object that was used to invoke the subroutine that **this** is used within. The **this** keyword shall only be used within non-static class methods, otherwise an error shall be issued. For example, the following declaration is a common way to write an initialization task:

LRM 48

```
class Demo ;
    integer x;

    function new (integer x)
        this.x = x;
    endfunction
endclass
```

The **x** is now both a property of the class and an argument to the function **new**. In the function **new**, an unqualified reference to **x** shall be resolved by looking at the innermost scope, in this case the subroutine argument declaration. To access the instance class property, it is qualified with the **this** keyword, to refer to the current instance.

LRM 48

Note that in writing methods, members can be qualified with **this** to refer to the current instance, but it is usually unnecessary.

11.11 Assignment, re-naming and copying

Declaring a class variable only creates the name by which the object is known. Thus:

```
Packet p1;
```

creates a variable, **p1**, that can hold the handle of an object of class **Packet**, but the initial value of **p1** is **null**. The object does not exist, and **p1** does not contain an actual handle, until an instance of type **Packet** is created:

```
p1 = new;
```

Thus, if another variable is declared and assigned the old handle, **p1**, to the new one, as in:

```
Packet p2;
p2 = p1;
```

then there is still only one object, which can be referred to with either the name **p1** or **p2**. Note, **new** was executed only once, so only one object has been created.

If, however, the example above is re-written as shown below, a copy of **p1** shall be made:

```
Packet p1;
Packet p2;
p1 = new;
p2 = new p1;
```

The last statement has **new** executing a second time, thus creating a new object **p2**, whose class properties are copied from **p1**. This is known as a *shallow copy*. All of the variables are copied across: integers, strings, instance handles, etc. Objects, however, are not copied, only their handles; as before, two names for the same object have been created. This is true even if the class declaration includes the instantiation operator **new**:

LRM 48

```
class A ;
    integer j = 5;
endclass
```

```
class B ;
    integer i = 1;
    A a = new;
endclass

function integer test;
    B b1 = new;          // Create an object of class B
    B b2 = new b1;       // Create an object that is a copy of b1
    b2.i = 10;           // i is changed in b2, but not in b1
    b2.a.j = 50;         // change a.j, shared by both b1 and b2
    test = b1.i;         // test is set to 1 (b1.i has not changed)
    test = b1.a.j;       // test is set to 50 (a.j has changed)
endfunction
```

Several things are noteworthy. First, class properties and instantiated objects can be initialized directly in a class declaration. Second, the shallow copy does not copy objects. Third, instance qualifications can be chained as needed to reach into objects or to reach through objects:

LRM 48

```
b1.a.j          // reaches into a, which is a property of b1
p.next.next.val // chain through a sequence of handles to get to val
```

To do a full (deep) copy, where everything (including nested objects) are copied, custom code is typically needed. For example:

```
Packet p1 = new;
Packet p2 = new;
p2.copy(p1);
```

where `copy(Packet p)` is a custom method written to copy the object specified as its argument into its instance.

11.12 Inheritance and subclasses

The previous sections defined a class called `Packet`. This class can be extended so that the packets can be chained together into a list. One solution would be to create a new class called `LinkedPacket` that contains a variable of type `Packet` called `packet_c`.

To refer to a class property of `Packet`, the variable `packet_c` needs to be referenced.

LRM 48

```
class LinkedPacket;
    Packet packet_c;
    LinkedPacket next;

    function LinkedPacket get_next();
        get_next = next;
    endfunction
endclass
```

Since `LinkedPacket` is a specialization of `Packet`, a more elegant solution is to extend the class creating a new subclass that *inherits* the members of the parent class. Thus, for example:

```
class LinkedPacket extends Packet;
    LinkedPacket next;

    function LinkedPacket get_next();
        get_next = next;
    endfunction
```

```
endclass
```

Now, all of the methods and class properties of `Packet` are part of `LinkedPacket`—as if they were defined in `LinkedPacket`—and `LinkedPacket` has additional class properties and methods.

LRM 48

The parent's methods can also be overridden, changing their definitions.

The mechanism provided by SystemVerilog is called *Single-Inheritance*, that is, each class is derived from a single parent class.

11.13 Overridden members

Subclass objects are also legal representative objects of their parent classes. For example, every `LinkedPacket` object is a perfectly legal `Packet` object.

The handle of a `LinkedPacket` object can be assigned to a `Packet` variable:

```
LinkedPacket lp = new;
Packet p = lp;
```

In this case, references to `p` access the methods and class properties of the `Packet` class. So, for example, if class properties and methods in `LinkedPacket` are overridden, these overridden members referred to through `p` get the original members in the `Packet` class. From `p`, `new` and all overridden members in `LinkedPacket` are now hidden.

LRM 48

```
class Packet;
    integer i = 1;
    function integer get();
        get = i;
    endfunction
endclass

class LinkedPacket extends Packet;
    integer i = 2;
    function integer get();
        get = -i;
    endfunction
endclass
```

```
LinkedPacket lp = new;
Packet p = lp;
j = p.i;           // j = 1, not 2
j = p.get();      // j = 1, not -1 or -2
```

To call the overridden method via a parent class object (`p` in the example), the method needs to be declared `virtual` (see Section 11.19).

11.14 Super

The `super` keyword is used from within a derived class to refer to members of the parent class. It is necessary to use `super` to access members of a parent class when those members are overridden by the derived class.

```
class Packet;                               //parent class
    integer value;
    function integer delay();
        delay = value * value;
```



```
    endfunction
endclass

class LinkedPacket extends Packet;    //derived class
    integer value;
    function integer delay();
        delay = super.delay()+ value * super.value;
    endfunction
endclass
```

The member can be a member declared a level up or be inherited by the class one level up. There is no way to reach higher (for example, `super.super.count` is not allowed).

Subclasses (or derived classes) are classes that are extensions of the current class. Whereas superclasses (parent classes or base classes) are classes that the current class is extended from, beginning with the original base class.

Note: When using the `super` within `new`, `super.new` must shall be the first executable statement executed in the constructor. This is because the superclass must be initialized before the current class and if the user code doesn't provide an initialization, the compiler shall insert a call to `super.new` automatically.

LRM 250

11.15 Casting

It is always legal to assign a subclass variable to a variable of a class higher in the inheritance tree. It is never legal to directly assign a superclass variable to a variable of one of its subclasses. However, it is legal to assign a superclass handle to a subclass variable if the superclass handle refers to an object of the given subclass.

To check if the assignment is legal, the dynamic cast function `$cast()` is used (see Section 3.15).

The syntax for `$cast()` is:

```
task $cast( singular dest_handle, singular source_handle );
```

or

```
function int $cast( singular dest_handle, singular source_handle );
```

When used with object handles, `$cast()` checks the hierarchy tree (super and subclasses) of the `source_expr` to see if it contains the class of `dest_handle`. If it does, `$cast()` does the assignment. Otherwise the error handling is as described in Section 3.15.

11.16 Chaining constructors

When a subclass is instantiated, the class method `new()` is invoked. The first action `new()` takes, before any code defined in the function is evaluated, is to invoke the `new()` method of its superclass, and so on up the inheritance hierarchy. Thus, all the constructors are called, in the proper order, beginning with the root base class and ending with the current class.

If the initialization method of the superclass requires arguments, there are two choices. To always supply the same arguments, or to use the `super` keyword. If the arguments are always the same, then they can be specified at the time the class is extended:

```
class EtherPacket extends Packet(5);
```

This passes 5 to the `new` routine associated with `Packet`.

A more general approach is to use the `super` keyword, to call the superclass constructor:

```
function new();
    super.new(5);
endfunction
```

To use this approach, `super.new(...)` must be the first executable statement in the function `new`.

11.17 Data hiding and encapsulation

So far, all class properties and methods have been made available to the outside world without restriction. Often, it is desirable to restrict access to class properties and methods from outside the class by hiding their names. This keeps other programmers from relying on a specific implementation, and it also protects against accidental modifications to class properties that are internal to the class. When all data becomes hidden—being accessed only by public methods—testing and maintenance of the code becomes much easier.

LRM 48

In SystemVerilog, unqualified class properties and methods are public, available to anyone who has access to the object's name.

LRM 48

A member identified as `local` is available only to methods inside the class. Further, these local members are not visible within subclasses. Of course, non-local methods that access local class properties or methods can be inherited, and work properly as methods of the subclass.

LRM 48

A `protected` class property or method has all of the characteristics of a `local` member, except that it can be inherited; it is visible to subclasses.

LRM 48

Note that within the class, a local method or class property of the class can be referenced, even if it is in a different instance. For example:

LRM 48

```
class Packet;
    local integer i;
    function integer compare (Packet other);
        compare = (this.i == other.i);
    endfunction
endclass
```

A strict interpretation of encapsulation might say that `other.i` should not be visible inside of this packet, since it is a local class property being referenced from outside its instance. Within the same class, however, these references are allowed. In this case, `this.i` shall be compared to `other.i` and the result of the logical comparison returned.

LRM 48

Class members can be identified as either `local` or `protected`; class properties can be further defined as `const`, and methods can be defined as `virtual`. There is no predefined ordering for specifying these modifiers; however, they can only appear once per member. It shall be an error to define members to be both `local` and `protected`, or to duplicate any of the other modifiers.

LRM 48

11.18 Constant class properties

LRM 48

Class properties can be made read-only by a `const` declaration like any other SystemVerilog variable. However, because class objects are dynamic objects, class properties allow two forms of read-only variables: global constants and instance constants.

Global constant class properties are those that include an initial value as part of their declaration. They are similar to other `const` variables in that they cannot be assigned a value anywhere other than in the declaration.

LRM 48

```
class Jumbo_Packet;
    const int max_size = 9 * 1024; // global constant
    byte payload [];
    function new( int size );
        payload = new[ size > max_size ? max_size : size ];
    endfunction
endclass
```

```
    endfunction
endclass
```

Instance constants do not include an initial value in their declaration, only the `const` qualifier. This type of constant can be assigned a value at run-time, but the assignment can only be done once in the corresponding class constructor.

```
class Big_Packet;
    const int size; // instance constant
    byte payload [];
    function new();
        size = $random % 4096; //one assignment in new -> ok
        payload = new[ size ];
    endfunction
endclass
```

Typically, global constants are also declared `static` since they are the same for all instances of the class. However, an instance constant cannot be declared `static`, since that would disallow all assignments in the constructor.

11.19 Abstract classes and virtual methods

A set of classes can be created that can be viewed as all being derived from a common base class. For example, a common base class of type `BasePacket` that sets out the structure of packets but is incomplete would never be instantiated. From this base class, though, a number of useful subclasses could be derived, such as Ethernet packets, token ring packets, GPSS packets, satellite packets. Each of these packets might look very similar, all needing the same set of methods, but they could vary significantly in terms of their internal details.

A base class sets out the prototype for the subclasses. Since the base class is not intended to be instantiated, it can be made *abstract* by specifying the class to be `virtual`:

```
virtual class BasePacket;
```

Abstract classes can also have *virtual* methods. Virtual methods are a basic polymorphic construct. A virtual method overrides a method in all the base classes, whereas a normal method only overrides a method in that class and its descendants. One way to view this is that there is only one implementation of a virtual method per class hierarchy, and it is always the one in the latest derived class. Virtual methods provide prototypes for sub-routines, all of the information generally found on the first line of a method declaration: the encapsulation criteria, the type and number of arguments, and the return type if it is needed. Later, when subclasses override virtual methods, they must follow the prototype exactly. Thus, all versions of the virtual method look identical in all subclasses:

LRM 51

```
virtual class BasePacket;
    virtual function integer send(bit[31:0] data);
endfunction
endclass
```

```
class EtherPacket extends BasePacket;
    function integer send(bit[31:0] data);
        // body of the function
        ...
    endfunction
endclass
```

LRM 52

`EtherPacket` is now a class that can be instantiated. In general, if an abstract class has any virtual methods, all of the methods must be overridden (and provided with a method body) for the subclass to be instantiated. If any virtual methods have no implementation, the subclass needs to be abstract.

An abstract class can contain methods for which there is only a prototype and no implementation (i.e., an incomplete class). An abstract class cannot be instantiated, it can only be derived. Methods of normal classes can also be declared virtual. In this case, the method must have a body. If the method does have a body, then the class can be instantiated, as can its subclasses.

11.20 Polymorphism: dynamic method lookup

Polymorphism allows the use of a variable in the superclass to hold subclass objects, and to reference the methods of those subclasses directly from the superclass variable. As an example, assume the base class for the Packet objects, `BasePacket` defines, as virtual functions, all of the public methods that are to be generally used by its subclasses, methods such as `send`, `receive`, `print`, etc. Even though `BasePacket` is abstract, it can still be used to declare a variable:

```
BasePacket packets[100];
```

Now, instances of various packet objects can be created, and put into the array:

```
EtherPacket ep = new; // extends BasePacket
TokenPacket tp = new; // extends BasePacket
GPSSPacket gp = new; // extends EtherPacket
packets[0] = ep;
packets[1] = tp;
packets[2] = gp;
```

If the data types were, for example, integers, bits and strings, all of these types could not be stored into a single array, but with *polymorphism*, it can be done. In this example, since the methods were declared as `virtual`, the appropriate subclass methods can be accessed from the superclass variable, even though the compiler didn't know—at compile time—what was going to be loaded into it.

For example, `packets[1]`:

```
packets[1].send();
```

shall invoke the `send` method associated with the `TokenPacket` class. At run-time, the system correctly binds the method from the appropriate class.

This is a typical example of polymorphism at work, providing capabilities that are far more powerful than what is found in a non-object-oriented framework.

11.21 Class scope resolution operator ::

The class scope operator `::` is used to specify an identifier defined within the scope of a class. It has the following form:

```
class_identifier :: { class_identifier :: } identifier
```

Identifiers on the left side of the scope-resolution operator (`::`) can be class names or package names (see Section 18.2). LRM 174

Because classes and other scopes can have the same identifiers, the scope resolution operator uniquely identifies a member of a particular class. In addition, to disambiguating class scope identifiers, the `::` operator also allows access to static members (class properties and methods) from outside the class, as well as access to public or protected elements of a super-classes from within the derived classes. LRM 48

```
class Base;
  typedef enum {bin,oct,dec,hex} radix;
  static task print( radix r, integer n ); ... endtask
```

```
    endclass
    ...
    Base b = new;
    int bin = 123;
    b.print( Base::bin, bin );    // Base::bin and bin are different
    Base::print( Base::hex, 66 );
```

In SystemVerilog, the class scope operator applies to all static elements of a class: static class properties, static methods, typedefs, enumerations, structures, unions, and nested class declarations. Class-scope resolved expressions can be read (in expressions), written (in assignments or subroutines calls) or triggered off (in event expressions). They can also be used as the name of a type or a method call.

Like modules, classes are scopes and can nest. Nesting allows hiding of local names and local allocation of resources. This is often desirable when a new type is needed as part of the implementation of a class. Declaring types within a class helps prevent name collisions, and cluttering the outer scope with symbols that are used only by that class. Type declarations nested inside a class scope are public and can be accessed outside the class.

```
class StringList;
    class Node; // Nested class for a node in a linked list.
        string name;
        Node link;
    endclass
endclass

class StringTree;
    class Node; // Nested class for a node in a binary tree.
        string name;
        Node left, right;
    endclass
endclass
// StringList::Node is different from StringTree::Node
```

The scope resolution operator enables:

- Access to static public members (methods and class properties) from outside the class hierarchy. LRM 48
- Access to public or protected class members of a super-class from within the derived classes.
- Access to type declarations and enumeration named constants declared inside the class from outside the class hierarchy or from within derived classes. LRM 185

11.22 Out of block declarations

It is convenient to be able to move method definitions out of the body of the class declaration. This is done in two steps. Declare, within the class body, the method prototypes—whether it is a function or task, any qualifiers (**local**, **protected** or **virtual**), and the full argument specification plus the **extern** qualifier. The **extern** qualifier indicates that the body of the method (its implementation) is to be found outside the declaration. Then, outside the class declaration, declare the full method—like the prototype but without the qualifiers—and, to tie the method back to its class, qualify the method name with the class name and a pair of colons:

```
class Packet;
    Packet next;
    function Packet get_next(); // single line
        get_next = next;
    endfunction

    // out-of-body (extern) declaration
    extern protected virtual function int send(int value);
```

```

endclass

function int Packet::send(int value);
    // dropped protected virtual, added Packet::
    // body of method
    ...
endfunction

```

The out of block method declaration must match the prototype declaration exactly; the only syntactical difference is that the method name is preceded by the class name and scope operator (: :).

Out of block declarations must be declared in the same scope as the class declaration.

LRM 53

11.23 Parameterized classes

It is often useful to define a generic class whose objects can be instantiated to have different array sizes or data types. This avoids writing similar code for each size or type, and allows a single specification to be used for objects that are fundamentally different, and (like a templated class in C++) not interchangeable.

The normal Verilog parameter mechanism is used to parameterize a class:

```

class vector #(int size = 1);
    bit [size-1:0] a;
endclass

```

LRM 86

Instances of this class can then be instantiated like modules or interfaces:

```

vector #(10) vten;           // object with vector of size 10
vector #(.size(2)) vtwo;    // object with vector of size 2
typedef vector#(4) Vfour;  // Class with vector of size 4

```

This feature is particularly useful when using types as parameters:

```

class stack #(type T = int);
    local T items[];
    task push( T a ); ... endtask
    task pop( ref T a ); ... endtask
endclass

```

LRM 86

The above class defines a generic *stack* class that can be instantiated with any arbitrary type:

```

stack is;                    // default: a stack of int's
stack#(bit[1:10]) bs;       // a stack of 10-bit vector
stack#(real) rs;           // a stack of real numbers

```

Any type can be supplied as a parameter, including a user-defined type such as a **class** or **struct**.

The combination of a generic class and the actual parameter values is called a specialization (or variant). Each specialization of a class has a separate set of **static** member variables (this is consistent with C++ templated classes). To share static member variables among several class specializations, they must be placed in a non-parameterized base class.

```

class vector #(int size = 1);
    bit [size-1:0] a;
    static int count = 0;
    function void disp_count();
        $display( "count: %d of size %d", count, size );
    endfunction

```

LRM 86

```
endclass
```

The variable `count` in the example above can only be accessed by the corresponding `disp_count` method. Each specialization of the class `vector` has its own unique copy of `count`.

To avoid having to repeat the specialization either in the declaration or to create parameters of that type, a **typedef** should be used:

```
typedef vector#(4) Vfour;
typedef stack#(Vfour) Stack4;
Stack4 s1, s2;                // declare objects of type Stack4
```

A parameterized class can extend another parameterized class. For example:

LRM 57

```
class C #(parameter type T = bit); ... endclass    // base class
class D1 #(parameter type P = real) extends C;    // T is bit (the default)
class D2 #(parameter type P = real) extends C #(integer); // T is integer
class D3 #(parameter type P = real) extends C #(P); // T is P
```

Class `D1` extends the base class `C` using the base class's default type (`bit`) parameter. Class `D2` extends the base class `C` using an `integer` parameter. Class `D3` extends the base class `C` using the parameterized type (`P`) with which the extended class is parameterized.

11.24 Typedef class

Sometimes a class variable needs to be declared before the class itself has been declared. For example, if two classes each need a handle to the other. When, in the course of processing the declaration for the first class, the compiler encounters the reference to the second class, that reference is undefined and the compiler flags it as an error.

This is resolved using **typedef** to provide a forward declaration for the second class:

```
typedef class C2;           // C2 is declared to be of type class
class C1;
    C2 c;
endclass
class C2;
    C1 c;
endclass
```

LRM 64

In this example, `C2` is declared to be of type `class`, a fact that is re-enforced later in the source code. Note that the `class` construct always creates a type, and does not require a **typedef** declaration for that purpose (as in **typedef class** ...). This is consistent with common C++ use.

Note that the `class` keyword in the statement `typedef class C2;` is not necessary, and is used only for documentation purposes. The statement `typedef C2;` is equivalent and shall work the same way.

11.25 Classes, structures, and unions

SystemVerilog adds the object-oriented `class` construct. On the surface, it might appear that `class` and `struct` provide equivalent functionality, and only one of them is needed. However, that is not true; `class` differs from `struct` in four fundamental ways:

- 1) SystemVerilog `struct` are strictly static objects; they are created either in a static memory location (global or module scope) or on the stack of an automatic task. Conversely, SystemVerilog objects (i.e., class instances) are exclusively dynamic, their declaration doesn't create the object; that is done by calling `new`.

- 2) SystemVerilog structs are type compatible so long as their bit sizes are the same, thus copying structs of different composition but equal sizes is allowed. In contrast, SystemVerilog objects are strictly strongly-typed. Copying an object of one type onto an object of another is not allowed.
- 3) SystemVerilog objects are implemented using handles, thereby providing C-like pointer functionality. But, SystemVerilog disallows casting handles onto other data types, thus, unlike C, SystemVerilog handles are guaranteed to be safe.
- 4) SystemVerilog objects form the basis of an Object-Oriented data abstraction that provides true polymorphism. Class inheritance, abstract classes, and dynamic casting are powerful mechanisms that go way beyond the mere encapsulation mechanism provided by structs.

11.26 Memory management

Memory for objects, strings, and dynamic and associative arrays is allocated dynamically. When objects are created, SystemVerilog allocates more memory. When an object is no longer needed, SystemVerilog automatically reclaims the memory, making it available for re-use. The automatic memory management system is an integral part of SystemVerilog. Without automatic memory management, SystemVerilog's multi-threaded, re-entrant environment creates many opportunities for users to run into problems. A manual memory management system, such as the one provided by C's `malloc` and `free`, would not be sufficient.

For example, consider the following example:

```
myClass obj = new;  
fork  
    task1( obj );  
    task2( obj );  
join_none
```

In this example, the main process (the one that forks off the two tasks) does not know when the two processes might be done using the object `obj`. Similarly, neither `task1` nor `task2` knows when any of the other two processes will no longer be using the object `obj`. It is evident from this simple example that no single process has enough information to determine when it is safe to free the object. The only two options available to the user are (1) play it safe and never reclaim the object, or (2) add some form of reference count that can be used to determine when it might be safe to reclaim the object. Adopting the first option can cause the system to quickly run out of memory. The second option places a large burden on users, who, in addition to managing their testbench, must also manage the memory using less than ideal schemes. To avoid these shortcomings, SystemVerilog manages all dynamic memory automatically. Users do not need to worry about dangling references, premature deallocation, or memory leaks. The system shall automatically reclaim any object that is no longer being used. In the example above, all that users do is assign `null` to the handle `obj` when they no longer need it. Similarly, when an object goes out of scope the system implicitly assigns `null` to the object.

Section 12

Random Constraints

12.1 Introduction (informative)

Constraint-driven test generation allows users to automatically generate tests for functional verification. Random testing can be more effective than a traditional, directed testing approach. By specifying constraints, one can easily create tests that can find hard-to-reach corner cases. SystemVerilog allows users to specify constraints in a compact, declarative way. The constraints are then processed by a solver that generates random values that meet the constraints.

The random constraints are ~~built~~ typically specified on top of an object oriented data abstraction that models the data to be randomized as objects that contain random variables and user-defined constraints. The constraints determine the legal values that can be assigned to the random variables. Objects are ideal for representing complex aggregate data types and protocols such as Ethernet packets.

LRM 252

Section 12.2 provides an overview of object-based randomization and constraint programming. The rest of this section provides detailed information on random variables, constraint blocks, and the mechanisms used to manipulate them.

12.2 Overview

This section introduces the basic concepts and uses for generating random stimulus within objects. SystemVerilog uses an object-oriented method for assigning random values to the member variables of an object, subject to user-defined constraints. For example:

```
class Bus;
    rand bit [15:0] addr;
    rand bit [31:0] data;

    constraint word_align {addr[1:0] == 2'b0;}
endclass
```

The `Bus` class models a simplified bus with two random variables: `addr` and `data`, representing the address and data values on a bus. The `word_align` constraint declares that the random values for `addr` must be such that `addr` is word-aligned (the low-order 2 bits are 0).

The `randomize()` method is called to generate new random values for a bus object:

```
Bus bus = new;

repeat (50) begin
    if ( bus.randomize() == 1 )
        $display ("addr = %16h data = %h\n", bus.addr, bus.data);
    else
        $display ("Randomization failed.\n");
end
```

Calling `randomize()` causes new values to be selected for all of the random variables in an object such that all of the constraints are true (satisfied). In the program test above, a `bus` object is created and then randomized 50 times. The result of each randomization is checked for success. If the randomization succeeds, the new random values for `addr` and `data` are printed; if the randomization fails, an error message is printed. In this example, only the `addr` value is constrained, while the `data` value is unconstrained. Unconstrained variables are assigned any value in their declared range.

Constraint programming is a powerful method that lets users build generic, reusable objects that can later be

extended or constrained to perform specific functions. The approach differs from both traditional procedural and object-oriented programming, as illustrated in this example that extends the `Bus` class:

```
typedef enum {low, mid, high} AddrType;

class MyBus extends Bus;
  rand AddrType atype;
  constraint addr_range
  {
    (atype == low ) -> addr inside { [0 : 15] };
    (atype == mid ) -> addr inside { [16 : 127] };
    (atype == high) -> addr inside { [128 : 255] };
  }
endclass
```

LRM 71

The `MyBus` class inherits all of the random variables and constraints of the `Bus` class, and adds a random variable called `atype` that is used to control the address range using another constraint. The `addr_range` constraint uses implication to select one of three range constraints depending on the random value of `atype`. When a `MyBus` object is randomized, values for `addr`, `data`, and `atype` are computed such that all of the constraints are satisfied. Using inheritance to build layered constraint systems enables the development of general-purpose models that can be constrained to perform application-specific functions.

Objects can be further constrained using the `randomize()` `with` construct, which declares additional constraints in-line with the call to `randomize()`:

```
task exercise_bus (MyBus bus);
  int res;

  // EXAMPLE 1: restrict to small addresses
  res = bus.randomize() with with {atype == small;};

  // EXAMPLE 2: restrict to address between 10 and 20
  res = bus.randomize() with with {10 <= addr && addr <= 20;};

  // EXAMPLE 3: restrict data values to powers-of-two
  res = bus.randomize() with with {data & (data - 1) == 0;};
endtask
```

LRM 252

This example illustrates several important properties of constraints:

- Constraints can be any SystemVerilog expression with variables and constants of integral type (`bit`, `reg`, `logic`, `integer`, `enum`, `packed struct`, etc.).
- The constraint solver must be able to handle a wide spectrum of equations, such as algebraic factoring, complex boolean expressions, and mixed integer and bit expressions. In the example above, the power-of-two constraint was expressed arithmetically. It could have also been defined with expressions using a shift operator. For example, $1 \ll n$, where n is a 5-bit random variable.
- If a solution exists, the constraint solver must find it. The solver can fail only when the problem is over-constrained and there is no combination of random values that satisfy the constraints.
- Constraints interact bidirectionally. In this example, the value chosen for `addr` depends on `atype` and how it is constrained, and the value chosen for `atype` depends on `addr` and how it is constrained. All expression operators are treated bidirectionally, including the implication operator (`->`).
- Constraints support only 2-state values. 4-state values (X and or Z) values and or 4-state operators (e.g., `===`, `!==`) are illegal and shall result in an error.

LRM 71

LRM 252

LRM 116

Sometimes it is desirable to disable constraints on random variables. For example, to deliberately generate an illegal address (non-word aligned):

```

task exercise_illegal(MyBus bus, int cycles);
    int res;

    // Disable word alignment constraint.
    bus.word_align.constraint_mode(0);

    repeat (cycles) begin

        // CASE 1: restrict to small addresses.
        res = bus.randomize() with {addr[0] || addr[1];};
        ...
    end

    // Re-enable word alignment constraint
    bus.word_align.constraint_mode(1);
endtask

```

The `constraint_mode()` method can be used to enable or disable any named constraint block in an object. In this example, the word-alignment constraint is disabled, and the object is then randomized with additional constraints forcing the low-order address bits to be non-zero (and thus unaligned).

The ability to enable or disable constraints allows users to design constraint hierarchies. In these hierarchies, the lowest level constraints can represent physical limits grouped by common properties into named constraint blocks, which can be independently enabled or disabled.

Similarly, the `rand_mode()` method can be used to enable or disable any random variable. When a random variable is disabled, it behaves in exactly the same way as other nonrandom variables.

Occasionally, it is desirable to perform operations immediately before or after randomization. That is accomplished via two built-in methods, `pre_randomize()` and `post_randomize()`, which are automatically called before and after randomization. These methods can be overridden with the desired functionality:

LRM 54

```

class XYPair;
    rand integer x, y;
endclass

class MyYXPair extends XYPair
    function void pre_randomize();
        super super.pre_randomize();
        $display("Before randomize x=%0d, y=%0d", x, y);
    endfunction

    function void post_randomize();
        super.post_randomize();
        $display("After randomize x=%0d, y=%0d", x, y);
    endfunction
endclass

```

LRM 252

By default, `pre_randomize()` and `post_randomize()` call their overridden parent class methods. When `pre_randomize()` or `post_randomize()` are overridden, care must be taken to invoke the parent class' methods, unless the class is a base class (has no parent class), otherwise the base class methods shall not be called.

LRM 54

The random stimulus generation capabilities and the object-oriented constraint-based verification methodology enable users to quickly develop tests that cover complex functionality and better assure design correctness.

12.3 Random variables

Class variables can be declared random using the **rand** and **randc** type-modifier keywords.

The syntax to declare a random variable in a class is:

```
class_property ::= // from Annex A.1.8
    { property_qualifier } data_declaration
property_qualifier8 ::=
    rand
    | randc
```

Syntax 12-1—Random variable declaration syntax (excerpt from Annex A)

- The solver can randomize singular variables of any integral type.
- Arrays can be declared **rand** or **randc**, in which case all of their member elements are treated as **rand** or **randc**.
- Dynamic and associative arrays can be declared **rand** or **randc**. All of the elements in the array are randomized, overwriting any previous data. If the array elements are object handles, all of the array elements must be non-null. Individual array elements can be constrained, in which case the index expression must be a literal constant.
- The size of a dynamic array declared as **rand** or **randc** can also be constrained. In that case, the array shall be resized according to the size constraint, and then all the array elements shall be randomized. The array size constraint is declared using the `size` method. For example,

```
rand bit [7:0] len;
rand integer data[];
constraint db { data.size == len; }
```

The variable `len` is declared to be 8 bits wide. The randomizer computes a random value for the `len` variable in the 8-bit range of 0 to 255, and then randomizes the first `len` elements of the `data` array.

If a dynamic array's size is not constrained then `randomize()` randomizes all the elements in the array.

- An object handle can be declared **rand** in which case all of that object's variables and constraints are solved concurrently with the variables and constraints of the object that contains the handle. Objects cannot be declared **randc**.

12.3.1 rand modifier

Variables declared with the **rand** keyword are standard random variables. Their values are uniformly distributed over their range. For example:

```
rand bit [7:0] y;
```

This is an 8-bit unsigned integer with a range of 0 to 255. If unconstrained, this variable shall be assigned any value in the range 0 to 255 with equal probability. In this example, the probability of the same value repeating on successive calls to `randomize` is 1/256.

12.3.2 randc modifier

Variables declared with the **randc** keyword are random-cyclic variables that cycle through all the values in a random permutation of their declared range. Random-cyclic variables can only be of type **bit** or enumerated

types, and can be limited to a maximum size.

To understand `randc`, consider a 2-bit random variable `y`:

```
randc bit [1:0] y;
```

The variable `y` can take on the values 0, 1, 2, and 3 (range 0 to 3). `Randomize` computes an initial random permutation of the range values of `y`, and then returns those values in order on successive calls. After it returns the last element of a permutation, it repeats the process by computing a new random permutation.

The basic idea is that `randc` randomly iterates over all the values in the range and that no value is repeated within an iteration. When the iteration finishes, a new iteration automatically starts.

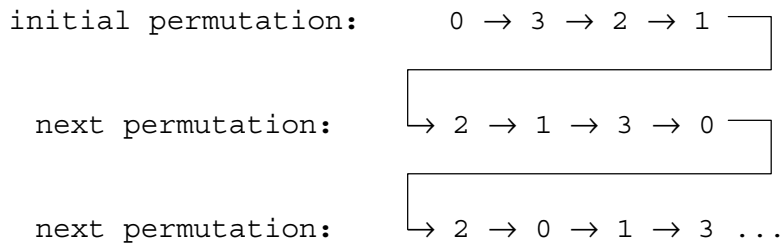

The permutation sequence for any given `randc` variable is recomputed whenever the constraints change on that variable, or when none of the remaining values in the permutation can satisfy the constraints.

To reduce memory requirements, implementations can impose a limit on the maximum size of a `randc` variable, but it should be no less than 8 bits.

The semantics of random-cyclical variables require that they be solved before other random variables. A set of constraints that includes both `rand` and `randc` variables shall be solved such that the `randc` variables are solved first, and this can sometimes cause `randomize()` to fail.

12.4 Constraint blocks

The values of random variables are determined using constraint expressions that are declared using constraint blocks. Constraint blocks are class members, like tasks, functions, and variables. Constraint block names must be unique within a class.

The syntax to declare a constraint block is:

```

constraint_declaration ::=                                     // from Annex A.1.9
    [ static ] constraint constraint_identifier { { constraint_block } }
constraint_block ::=
    solve identifier_list before identifier_list ;
    | constraint_expression
constraint_expression ::=
    expression ;
    | expression -> constraint_set
    | if ( expression ) constraint_set [ else constraint_set ]
    | expression dist { dist_list } ;
    | foreach ( array_identifier [ loop_variables ] ) constraint_set
constraint_set ::=
    constraint_expression
    | { { constraint_expression } }
dist_list ::= dist_item { , dist_item }
dist_item ::=
    value_range := expression
    | value_range := /expression
constraint_prototype ::= [ static ] constraint constraint_identifier
extern_constraint_declaration ::=
    [ static ] constraint class_identifier :: constraint_identifier { { constraint_block } }
identifier_list ::= identifier { , identifier }
loop_variables ::= [ index_variable_identifier ] { , [ index_variable_identifier ] } // from Annex A.6.8

```

LRM 252

LRM 63
LRM 70
LRM 71

Syntax 12-2—Constraint syntax (excerpt from Annex A)

constraint_identifier is the name of the constraint block. This name can be used to enable or disable a constraint using the `constraint_mode()` method (see Section 12.8).

constraint_block is a list of expression statements that restrict the range of a variable or define relations between variables. A *constraint_expression* is any SystemVerilog expression, or one of the constraint-specific operators: `->` and `dist` (see Sections 12.4.3, 12.4.4 and 12.4.5).

The declarative nature of constraints imposes the following restrictions on constraint expressions:

- Functions are allowed with certain limitations (see Section 12.4.11).
- Operators with side effects, such as `++` and `--` are not allowed.
- `randc` variables cannot be specified in ordering constraints (see `solve...before` in Section 12.4.9).
- `dist` expressions cannot appear in other expressions.

LRM 16

LRM 71

LRM 63

LRM 63

12.4.1 External constraint blocks

Constraint block bodies can be declared outside a class declaration, just like external task and function bodies:

```

// class declaration
class XYPair;
    rand integer x, y;
    constraint c;
endclass

```

```
// external constraint body declaration
constraint XYPair::c { x < y; }
```

12.4.2 Inheritance

Constraints follow the same general rules for inheritance as class variables, tasks, and functions:

- A constraint in a derived class that uses the same name as a constraint in its parent classes overrides the base class constraints. For example:

```
class A;
    rand integer x;
    constraint c { x < 0; }
endclass

class B extends A;
    constraint c { x > 0; }
endclass
```

An instance of class A constrains x to be less than zero whereas an instance of class B constrains x to be greater than zero. The extended class B overrides the definition of constraint c . In this sense, constraints are treated the same as virtual functions, so casting an instance of B to an A does not change the constraint set.

- The `randomize()` task is virtual. Accordingly, it treats the class constraints in a virtual manner. When a named constraint is **overloaded** **redefined in an extended class**, the previous definition is overridden.

LRM 252

12.4.3 Set membership

- Constraints support integer value sets and **the** set membership operators (as defined in Section 7.20).

LRM 252

Absent any other constraints, all values (either single values or value ranges), have an equal probability of being chosen by the **inside** operator.

LRM 16

- The negated form of **the inside operator** denotes that expression lies outside the set: `!(expression inside { set })`.

LRM 252

For example:

```
rand integer x, y, z;
constraint c1 {x inside {3, 5, [9:15], [24:32], [y:2*y], z};}

rand integer a, b, c;
constraint c2 {a inside {b, c};}

integer fives[0:3] = { 5, 10, 15, 20 };
rand integer v;
constraint c3 { v inside fives; }
```

- It is important to note that the **inside** operator is bidirectional, thus, the second example above is equivalent to `a == b || a == c`.

LRM 16

12.4.4 Distribution

In addition to set membership, constraints support sets of weighted values called distributions. Distributions have two properties: they are a relational test for set membership, and they specify a statistical distribution function for the results.

The syntax to define a distribution expression is:

```

constraint_block ::=                                     // from Annex A.1.9
    ...
    | expression dist { dist_list };
dist_list ::= dist_item { , dist_item }
dist_item ::= value_range [ dist_weight ]
             value_range := expression
             † value_range :/ expression
dist_weight ::=
             := expression
             | :/ expression
    
```

LRM 273

Syntax 12-3—Constraint distribution syntax (excerpt from Annex A)

expression can be any integral SystemVerilog expression.

The distribution operator **dist** evaluates to true if the value of the expression is contained in the set; otherwise it evaluates to false.

Absent any other constraints, the probability that the expression matches any value in the list is proportional to its specified weight.

The distribution set is a comma-separated list of integral expressions and ranges. Optionally, each term in the list can have a weight, which is specified using the `:=` or `:/` operators. If no weight is specified for an item, the default weight is `:= 1`. The weight can be any integral SystemVerilog expression.

LRM 276

The `:=` operator assigns the specified weight to the item, or if the item is a range, to every value in the range.

The `:/` operator assigns the specified weight to the item, or if the item is a range, to the range as a whole. If there are *n* values in the range, the weight of each value is `range_weight / n`.

For example:

```
x dist {100 := 1, 200 := 2, 300 := 5}
```

means *x* is equal to 100, 200, or 300 with weighted ratio of 1-2-5. If an additional constraint is added that specifies that *x* cannot be 200:

```
x != 200;
x dist {100 := 1, 200 := 2, 300 := 5}
```

then *x* is equal to 100 or 300 with weighted ratio of 1-5.

It is easier to think about mixing ratios, such as 1-2-5, than the actual probabilities because mixing ratios do not have to be normalized to 100%. Converting probabilities to mixing ratios is straightforward.

When weights are applied to ranges, they can be applied to each value in the range, or they can be applied to the range as a whole. For example,

```
x dist { [100:102] := 1, 200 := 2, 300 := 5}
```

means *x* is equal to 100, 101, 102, 200, or 300 with a weighted ratio of 1-1-1-2-5.

```
x dist { [100:102] :/ 1, 200 := 2, 300 := 5}
```

means x is equal to one of 100, 101, 102, 200, or 300 with a weighted ratio of 1/3-1/3-1/3-2-5.

In general, distributions guarantee two properties: set membership and monotonic weighting, which means that increasing a weight **shall increase** **increases** the likelihood of choosing those values.

LRM 252

Limitations:

- A **dist** operation shall not be applied to **randc** variables.
- A **dist** expression requires that expression contain at least one **rand** variable.

12.4.5 Implication

Constraints provide two constructs for declaring conditional (predicated) relations: *implication* and **if...else**.

The implication operator (**->**) can be used to declare an expression that implies a constraint.

LRM 71

The syntax to define an implication constraint is:

```
constraint_expression ::= //from Annex A.1.9
    ...
    | expression -> constraint_set
```

Syntax 12-4—Constraint implication syntax (excerpt from Annex A)

The *expression* can be any integral SystemVerilog expression.

The boolean equivalent of the implication operator $a \rightarrow b$ is $(!a \mid \mid b)$. This states that if the expression is true, then random numbers generated are constrained by the constraint (or constraint **block set**). Otherwise the random numbers generated are unconstrained.

LRM 252

The *constraint_set* represents any valid constraint or an unnamed constraint **block set**. If the expression is true, all of the constraints in the constraint **block set** must also be satisfied.

For example:

```
mode == small -> len < 10;
mode == large -> len > 100;
```

LRM 71

In this example, the value of `mode` implies that the value of `len` shall be constrained to less than 10 (`mode == small`), greater than 100 (`mode == large`), or unconstrained (`mode != small` and `mode != large`).

In the following example:

```
bit [3:0] a, b;
constraint c { (a == 0) -> (b == 1); }
```

Both `a` and `b` are 4 bits, so there are 256 combinations of `a` and `b`. Constraint `c` says that `a == 0` implies that `b == 1`, thereby eliminating 15 combinations: $\{0,0\}$, $\{0,2\}$, ... $\{0,15\}$. Therefore, the probability that `a == 0` is thus $1/(256-15)$ or $1/241$.

12.4.6 if...else constraints

if...else style constraints are also supported.

The syntax to define an **if...else** constraint is:

```
constraint_expression ::= //from Annex A.1.9
    ...
    | if ( expression ) constraint_set [ else constraint_set ]
```

Syntax 12-5—*if...else constraint syntax (excerpt from Annex A)*

expression can be any integral SystemVerilog expression.

constraint_set represents any valid constraint or an unnamed constraint block. If the expression is true, all of the constraints in the first constraint or constraint **block set** must be satisfied, otherwise all of the constraints in the optional **else** constraint or constraint-block must be satisfied. Constraint **blocks sets** can be used to group multiple constraints.

LRM 252

If...else style constraint declarations are equivalent to implications:

```
if (mode == small)
    len < 10;
else if (mode == large)
    len > 100;
```

is equivalent to

```
mode == small -> len < 10 ;
mode == large -> len > 100 ;
```

LRM 71

In this example, the value of `mode` implies that the value of `len` is less than 10, greater than 100, or unconstrained.

Just like implication, **if...else** style constraints are bidirectional. In the declaration above, the value of `mode` constrains the value of `len`, and the value of `len` constrains the value of `mode`.

LRM 2

Because the **else** part of an **if...else** style constraint declaration is optional, there can be confusion when an **else** is omitted from a nested **if** sequence. This is resolved by always associating the **else** with the closest previous **if** that lacks an **else**. In the example below, the **else** goes with the inner **if**, as shown by indentation:

```
if (mode != large)
    if (mode == small)
        len < 10;
    else // the else applies to preceding if
        len > 100;
```

12.4.7 Iterative Constraints

LRM 63

Iterative constraints allow arrayed variables to be constrained in a parameterized manner using loop variables and indexing expressions.

The syntax to define an iterative constraint is:

```
constraint_expression ::= //from Annex A.1.9
    ...
    | foreach ( array_identifier [ loop_variables ] ) constraint_set
loop_variables ::= [ index_variable_identifier ] { , [ index_variable_identifier ] } //from Annex A.6.8
```

LRM 248

Syntax 12-6—foreach iterative constraint syntax (excerpt from Annex A)

The **foreach** construct specifies iteration over the elements of an array. Its argument is an identifier that designates any type of array (fixed-size, dynamic, associative, or queue) followed by a list of loop variables enclosed in square brackets. Each loop variable corresponds to one of the dimensions of the array.

For example:

```
class C;
  rand byte A[] ;

  constraint C1 { foreach ( A [ i ] ) A[i] inside {2,4,8,16}; }
  constraint C2 { foreach ( A [ j ] ) A[j] > 2 * j; }
endclass
```

C1 constrains each element of the array A to be in the set [2,4,8,16]. C2 constrains each element of the array A to be greater than twice its index.

The number of loop variables must not exceed the number of dimensions of the array variable. The scope of each loop variable is the **foreach** constraint construct, including its `constraint_set`. The type of each loop variable is implicitly declared to be consistent with the type of array index. An empty loop variable indicates no iteration over that dimension of the array. As with default arguments, a list of commas at the end can be omitted, thus, `foreach(arr [j])` is a shorthand for `foreach(arr [j, , ,])`. It shall be an error for any loop variable to have the same identifier as the array.

The mapping of loop variables to array indexes is determined by the dimension cardinality, as described in Section 23.7.

```
//      1 2 3          3 4          1 2          -> Dimension numbers
int A [2][3][4];    bit [3:0][2:1] B [5:1][4];

foreach( A [ i, j, k ] ) ...
foreach( B [ q, r, , s ] ) ...
```

The first **foreach** causes *i* to iterate from 0 to 1, *j* from 0 to 2, and *k* from 0 to 3. The second **foreach** causes *q* to iterate from 5 to 1, *r* from 0 to 3, and *s* from 2 to 1.

Iterative constraints can include predicates. For example:

```
class C;
  rand int A[] ;

  constraint c1 { arr.size inside {[1:10]}; }
  constraint c2 { foreach ( A[ k ] ) (k < A.size - 1) -> A[k + 1] > A[k]; }
endclass
```

The first constraint, *c1*, constrains the size of the array A to be between 1 and 10. The second constraint, *c2*, constrains each array value to be greater than the preceding one, i.e., an array sorted in ascending order.

Within a **foreach**, predicate expressions involving only constants, state variables, object handle comparisons, loop variables, or the size of the array being iterated behave as guards against the creation of constraints, and not as logical relations. For example, the implication in constraint *c2* above involves only a loop variable and the size of the array being iterated, thus, it allows the creation of a constraint only when `k < A.size() - 1`, which in this case prevents an out-of-bounds access in the constraint. Guards are described in more detail in Section 12.4.12.

Index expressions can include loop variables, constants, and state variables. Invalid or out of bound array indexes are not automatically eliminated; users must explicitly exclude these indexes using predicates.

The size method of a dynamic or associative array can be used to constrain the size of the array (see constraint `c1` above). If an array is constrained by both size constraints and iterative constraints, the size constraints are solved first, and the iterative constraints next. As a result of this implicit ordering between size constraints and iterative constraints, the size method shall be treated as a state variable within the `foreach` block of the corresponding array. For example, the expression `A.size` is treated as a random variable in constraint `c1`, and as a state variable in constraint `c2`. This implicit ordering can cause the solver to fail in some situations.

12.4.8 Global constraints

When an object member of a class is declared `rand`, all of its constraints and random variables are randomized simultaneously along with the other class variables and constraints. Constraint expressions involving random variables from other objects are called global constraints.

```
class A;           // leaf node
  rand bit [7:0] v;
endclass

class B extends A; // heap node
  rand A left;
  rand A right;

  constraint heapcond {left.v <= v; right.v <= v;}
endclass
```

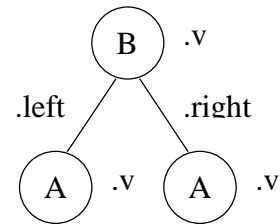

This example uses global constraints to define the legal values of an ordered binary tree. Class `A` represents a leaf node with an 8-bit value `* v`. Class `B` extends class `A` and represents a heap-node with value `v`, a left subtree, and a right subtree. Both subtrees are declared as `rand` in order to randomize them at the same time as other class variables. The constraint block named `heapcond` has two global constraints relating the left and right subtree values to the heap-node value. When an instance of class `B` is randomized, the solver simultaneously solves for `B` and its left and right children, which in turn can be leaf nodes or more heap-nodes.

LRM 252

The following rules determine which objects, variables, and constraints are to be randomized:

- 1) First, determine the set of objects that are to be randomized as a whole. Starting with the object that invoked the `randomize()` method, add all objects that are contained within it, are declared `rand`, and are active (see `rand_mode` in Section 12.7). The definition is recursive and includes all of the active random objects that can be reached from the starting object. The objects selected in this step are referred to as the active random objects.
- 2) Next, select all of the active constraints from the set of active random objects. These are the constraints that are applied to the problem.
- 3) Finally, select all of the active random variables from the set of active random objects. These are the variables that are to be randomized. All other variable references are treated as state variables, whose current value is used as a constant.

12.4.9 Variable ordering

The solver must assure that the random values are selected to give a uniform value distribution over legal value combinations (that is, all combinations of legal values have the same probability of being the solution). This important property guarantees that all legal value combinations are equally probable, which allows randomization to better explore the whole design space.

Sometimes, however, it is desirable to force certain combinations to occur more frequently. Consider the case where a 1-bit control variable `s` constrains a 32-bit data value `d`:

```
class B;
  rand bit s;
```

```

    rand bit [31:0] d;

    constraint c { s -> d == 0; }
endclass

```

LRM 71

The constraint *c* says “*s* implies *d* equals zero”. Although this reads as if *s* determines *d*, in fact *s* and *d* are determined together. There are 2^{32} valid combinations of $\{s, d\}$, but *s* is only true for $\{1, 0\}$. Thus, the probability that *s* is true is $1/2^{32}$, which is practically zero.

The constraints provide a mechanism for ordering variables so that *s* can be chosen independently of *d*. This mechanism defines a partial ordering on the evaluation of variables, and is specified using the `solve` keyword.

```

class B;
    rand bit s;
    rand bit [31:0] d;
    constraint c { s -> d == 0; }
    constraint order { solve s before d; }
endclass

```

LRM 71

In this case, the order constraint instructs the solver to solve for *s* before solving for *d*. The effect is that *s* is now chosen true with 50% probability, and then *d* is chosen subject to the value of *s*. Accordingly, $d == 0$ shall occur 50% of the time, and $d != 0$ shall occur for the other 50%.

Variable ordering can be used to force selected corner cases to occur more frequently than they would otherwise. However, a “`solve...before ...`” constraint does not change the solution space, and so cannot cause the solver to fail.

LRM 119

The syntax to define variable order in a constraint block is:

```

constraint_block ::=
    solve identifier_list before identifier_list ;
| constraint_expression

```

LRM 252

Syntax 12-7—Solve...before constraint ordering syntax (excerpt from Annex A)

`solve` and `before` each take a comma-separated list of integral variables or array elements.

The following restrictions apply to variable ordering:

- Only random variables are allowed, that is, they must be `rand`.
- `randc` variables are not allowed. `randc` variables are always solved before any other.
- The variables must be integral values.
- A constraint block can contain both regular value constraints and ordering constraints.
- There must be no circular dependencies in the ordering, such as “solve a before b” combined with “solve b before a”.
- Variables that are not explicitly ordered shall be solved with the last set of ordered variables. These values are deferred until as late as possible to assure a good distribution of values.
- Variables can be solved in an order that is not consistent with the ordering constraints, provided that the outcome is the same. An example situation where this might occur is:

```

x == 0;
x < y;
solve y before x;

```

In this case, since x has only one possible assignment (0), x can be solved for before y . The constraint solver can use this flexibility to speed up the solving process.

12.4.10 Static constraint blocks

A constraint block can be defined as static by including the `static` keyword in its definition.

The syntax to declare a static constraint block is:

```
static constraint constraint_identifier { constraint_expressions }
```

<pre>constraint_declaration ::= [static] constraint constraint_identifier { { constraint_block } }</pre>	<i>// from Annex A.1.9</i>
--	----------------------------

LRM 252

Syntax 12-8—Static constraint syntax (excerpt from Annex A)

If a constraint block is declared as `static`, then calls to `constraint_mode()` shall affect all instances of the specified constraint in all objects. Thus, if a static constraint is set to OFF, it is off for all instances of that particular class.

12.4.11 Functions in Constraints

LRM 63

Some properties are unwieldy or impossible to express in a single expression. For example, the natural way to compute the number of 1's in a packed array uses a loop:

```
function int count_ones ( bit [9:0] w );
    for( count_ones = 0; w != 0; w = w >> 1 )
        count_ones += w & 1'b1;
endfunction
```

Such a function could be used to constrain other random variables to the number of 1 bits:

```
constraint C1 { length == count_ones( v ) };
```

Without the ability to call a function, this constraint requires the loop to be unrolled and expressed as a sum of the individual bits:

```
constraint C2
{
    length == ((w>>9)&1) + ((w>>8)&1) + ((w>>7)&1) + ((w>>6)&1) + ((w>>5)&1) +
              ((w>>4)&1) + ((w>>3)&1) + ((w>>2)&1) + ((w>>1)&1) + ((w>>0)&1);
}
```

Unlike the `count_ones` function, more complex properties, which require temporary state or unbounded loops, may be impossible to convert into a single expression. The ability to call functions, thus, enhances the expressive power of the constraint language and reduces the likelihood of errors. Note that the two constraints above are not completely equivalent; C2 is bidirectional (length can constrain w and vice-versa), whereas C1 is not.

To handle these common cases, SystemVerilog allows constraint expressions to include function calls, but it imposes certain semantic restrictions.

- Functions that appear in constraint expressions cannot contain output or `ref` arguments (`const ref` are allowed).
- Functions that appear in constraint expressions should be automatic (or preserve no state information) and have no side effects.

- Functions that appear in constraints cannot modify the constraints, for example, calling `rand_mode` or `constraint_mode` methods.
- Functions shall be called before constraints are solved, and their return values shall be treated as state variables.
- Random variables used as function arguments shall establish an implicit variable ordering or priority. Constraints that include only variables with higher priority are solved before other, lower priority, constraints. Random variables solved as part of a higher priority set of constraints become state variables to the remaining set of constraints. For example:

```
class B;
  rand int x, y;
  constraint C { x <= F(y); };
  constraint D { y inside { 2, 4, 8 } };
endclass
```

Forces `y` to be solved before `x`. Thus, constraint `D` is solved separately before constraint `C`, which uses the values of `y` and `F(y)` as state variables. Note that the behavior for variable ordering implied by function arguments differs from the behavior for ordering specified using the “`solve...before...`” constraint; function argument variable ordering subdivides the solution space thereby changing it. Since constraints on higher-priority variables are solved without considering lower-priority constraints at all this subdivision can cause the overall constraints to fail. Within each prioritized set of constraints, cyclical (`randc`) variables are solved first.

LRM 119

- Circular dependencies created by the implicit variable ordering shall result in an error.
- Function calls in active constraints are executed an unspecified number of times (at least once), in an unspecified order.

12.4.12 Constraint guards

LRM 63

Constraint guards are predicate expressions that function as guards against the creation of constraints, and not as logical relations to be satisfied by the solver. These predicate expressions are evaluated before the constraints are solved, and are characterized by involving only the following items:

- constants
- state variables
- object handle comparisons (comparisons between two handles or a handle and the constant `null`)

In addition to the above, iterative constraints (see Section 12.4.7) also consider loop variables and the size of the array being iterated as state variables.

Treating these predicate expressions as constraint guards prevents the solver from generating evaluation errors, thereby failing on some seemingly correct constraints. This enables users to write constraints that avoid errors due to nonexistent object handles or array indices out of bounds. For example, the sort constraint of the singly-linked list, `SList`, shown below is intended to assign a random sequence of numbers that is sorted in ascending order. However, the constraint expression will fail on the last element when `next.n` results in an evaluation error due to a non-existent handle.

```
class SList;
  rand int n;
  rand SList next;

  constraint sort { n < next.n; }
endclass
```

The error condition above can be avoided by writing a predicate expression to guard against that condition:

```
constraint sort { if( next != null ) n < next.n; }
```

In the sort constraint above, the **if** prevents the creation of a constraint when `next == null`, which in this case avoids accessing a non-existent object. Both implication (\rightarrow) and **if...else** can be used as guards.

Guard expressions can themselves include sub-expressions that result in evaluation errors (e.g., null references), and they are also guarded from generating errors. This logical sifting is accomplished by evaluating predicate sub-expressions using the following 4-state representation:

- 0 **TRUE FALSE** Sub-expression evaluates to **TRUE FALSE**
- 1 **FALSE TRUE** Sub-expression evaluates to **FALSE TRUE**
- E **ERROR** Sub-expression causes an evaluation error
- R **RANDOM** Expression includes random variables and cannot be evaluated

LRM 252

Every sub-expression within a predicate expression is evaluated to yield one of the above four values. The sub-expressions are evaluated in an arbitrary order, and the result of that evaluation plus the logical operation define the outcome in the alternate 4-state representation. A conjunction (**&&**), disjunction (**||**), or negation (**!**) of sub-expressions can include some (perhaps all) guard sub-expressions. The following rules specify the resulting value for the guard:

- Conjunction (**&&**): If any one of the sub-expressions evaluates to **FALSE**, then the guard evaluates to **FALSE**. Otherwise, if any one sub-expression evaluates to **ERROR**, then the guard evaluates to **ERROR**, else the guard evaluates to **TRUE**.
 - If the guard evaluates to **FALSE** then the constraint is eliminated.
 - If the guard evaluates to **TRUE** then a (possibly conditional) constraint is generated.
 - If the guard evaluates to **ERROR** then an error is generated and randomize fails.
- Disjunction (**||**): If any one of the sub-expressions evaluates to **TRUE**, then the guard evaluates to **TRUE**. Otherwise, if any one sub-expression evaluates to **ERROR**, then the guard evaluates to **ERROR**, else the guard evaluates to **FALSE**.
 - If the guard evaluates to **FALSE** then a (possibly conditional) constraint is generated.
 - If the guard evaluates to **TRUE** then an unconditional constraint is generated.
 - If the guard evaluates to **ERROR** then an error is generated and randomize fails.
- Negation (**!**): If the sub-expression evaluates to **ERROR**, then the guard evaluates to **ERROR**. Otherwise, if the sub-expression evaluates to **TRUE** or **FALSE** then the guard evaluates to **FALSE** or **TRUE**, respectively.

LRM 252

These rules are codified by the following truth tables:

&&	0	1	E	R
0	0	0	0	0
1	0	1	E	R
E	0	E	E	E
R	0	R	E	R

Conjunction

 	0	1	E	R
0	0	1	E	R
1	1	1	1	1
E	E	1	E	E
R	R	1	E	R

Disjunction

!	
0	1
1	0
E	E
R	R

Negation

These above rules are applied recursively until all sub-expressions are evaluated. The final value of the evaluated predicate expression determines the outcome as follows:

- If the result is TRUE then an unconditional constraint is generated.
- If the result is FALSE then the constraint is eliminated, and can generate no error.
- If the result is ERROR then an unconditional error is generated and the constraint fails.
- If the final result of the evaluation is RANDOM then a **guarded conditional** constraint is generated.

LRM 252

When final value is RANDOM a traversal of the predicate expression tree is needed to collect all conditional guards that evaluate to RANDOM. When the final value is ERROR, a subsequent traversal of the expression tree is not required, allowing implementations to issue only one error.

Example 1:

```
class D;
    int x;
endclass

class C;
    rand int x, y;
    D a, b;
    constraint c1 { (x < y || a.x > b.x || a.x == 5 ) -> x+y == 10; }
endclass
```

In the example above, the predicate sub-expressions are $(x < y)$, $(a.x > b.x)$, and $(a.x == 5)$, which are all connected by disjunction. Some possible cases are:

- Case 1: a is non-**null**, b is **null**, a.x is 5.
 - Since $(a.x==5)$ is true, the fact that b.x generates an error does not result in an error.
 - The unconditional constraint $(x+y == 10)$ is generated.
- Case 2: a is **null**
 - This always results in error, irrespective of the other conditions.
- Case 3: a is non-**null**, b is non-**null**, a.x is 10, b.x is 20.
 - All the guard sub-expressions evaluate to FALSE.
 - The conditional constraint $(x<y) \rightarrow (x+y == 10)$ is generated.

Example 2:

```
class D;
    int x;
endclass

class C;
    rand int x, y;
    D a, b;
    constraint c1 { (x < y && a.x > b.x && a.x == 5 ) -> x+y == 10; }
endclass
```

In the example above, the predicate sub-expressions are $(x < y)$, $(a.x > b.x)$, and $(a.x == 5)$, which are all connected by conjunction. Some possible cases are:

- Case 1: a is non-**null**, b is **null**, a.x is 6.
 - Since $(a.x==5)$ is false, the fact that b.x generates an error does not result in an error.
 - The constraint is eliminated.
- Case 2: a is **null**

This always results in error, irrespective of the other conditions.

- Case 3: a is non-**null**, b is non-**null**, a . x is 5, b . x is 2.

All the guard sub-expressions evaluate to **TRUE**, producing constraint $(x < y) \rightarrow (x + y == 10)$.

Example 3:

```
class D;
    int x;
endclass

class C;
    rand int x, y;
    D a, b;
    constraint c1 { (x < y && (a.x > b.x || a.x == 5)) -> x+y == 10; }
endclass
```

In the example above, the predicate sub-expressions are $(x < y)$ and $(a.x > b.x || a.x == 5)$, which is connected by disjunction. Some possible cases are:

- Case 1: a is non-**null**, b is **null**, a . x is 5.

The guard expression evaluates to $(\text{ERROR} || a.x == 5)$, which evaluates to $(\text{ERROR} || \text{TRUE})$.

The guard sub-expression evaluates to **TRUE**.

The conditional constraint $(x < y) \rightarrow (x + y == 10)$ is generated.

- Case 2: a is non-**null**, b is **null**, a . x is 8.

The guard expression evaluates to $(\text{ERROR} || \text{FALSE})$, and generates an error.

- Case 3: a is **null**

This always results in error, irrespective of the other conditions.

- Case 4: a is non-**null**, b is non-**null**, a . x is 5, b . x is 2.

All the guard sub-expressions evaluate to **TRUE**.

The conditional constraint $(x < y) \rightarrow (x + y == 10)$ is generated.

12.5 Randomization methods

12.5.1 randomize()

Variables in an object are randomized using the `randomize()` class method. Every class has a built-in `randomize()` virtual method, declared as:

Conjunction

LRM 252

```
virtual function int randomize();
```

The `randomize()` method is a virtual function that generates random values for all the active random variables in the object, subject to the active constraints.

The `randomize()` method returns 1 if it successfully sets all the random variables and objects to valid values, otherwise it returns 0.

Example:

```
class SimpleSum;
    rand bit [7:0] x, y, z;
```

```
    constraint c {z == x + y;}
endclass
```

This class definition declares three random variables, `x`, `y`, and `z`. Calling the `randomize()` method shall randomize an instance of class `SimpleSum`:

```
SimpleSum p = new;
int success = p.randomize();
if (success == 1) ...
```

Checking the return status can be necessary because the actual value of state variables or addition of constraints in derived classes can render seemingly simple constraints unsatisfiable.

12.5.2 `pre_randomize()` and `post_randomize()`

Every class contains built-in `pre_randomize()` and `post_randomize()` functions, that are automatically called by `randomize()` before and after computing new random values.

The built-in definition for `pre_randomize()` is:

```
function void pre_randomize;
    if (super) super.pre_randomize(); // test super to see if the
                                     // object handle exists
    // Optional programming before randomization goes here
endfunction
```

The built-in definition for `post_randomize()` is:

```
function void post_randomize;
    if (super) super.post_randomize(); // test super to see if the
                                       // object handle exists
    // Optional programming after randomization goes here
endfunction
```

When `obj.randomize()` is invoked, it first invokes `pre_randomize()` on `obj` and also all of its random object members that are enabled. `pre_randomize()` then calls `super.pre_randomize()`. After the new random values are computed and assigned, `randomize()` invokes `post_randomize()` on `obj` and also all of its random object members that are enabled. `post_randomize()` then calls `super.post_randomize()`.

Users can override the `pre_randomize()` in any class to perform initialization and set pre-conditions before the object is randomized.

LRM 54

Users can override the `post_randomize()` in any class to perform cleanup, print diagnostics, and check post-conditions after the object is randomized.

If these methods are overridden, they must call their associated parent class methods, otherwise their pre- and post-randomization processing steps shall be skipped.

The `pre_randomize()` and `post_randomize()` methods are not virtual. However, because they are automatically called by the `randomize()` method, which is virtual, they appear to behave as virtual methods.

12.5.3 Randomization methods notes

- Random variables declared as static are shared by all instances of the class in which they are declared. Each time the `randomize()` method is called, the variable is changed in every class instance.
- If `randomize()` fails, the constraints are infeasible and the random variables retain their previous values.
- If `randomize()` fails, `post_randomize()` is not called.

- The `randomize()` method ~~shall not be built-in and cannot~~ be overridden. LRM 54
LRM 252
- The `randomize()` method implements object random stability. An object can be seeded by ~~the~~ `$srandom()` ~~system call~~ calling its `srandom()` method (see Section 12.12.3), ~~specifying the object in the second argument.~~
- The built-in methods `pre_randomize()` and `post_randomize()` are functions and cannot block.

12.6 In-line constraints — `randomize()` with

By using the `randomize()...with` construct, users can declare in-line constraints at the point where the `randomize()` method is called. These additional constraints are applied along with the object constraints.

The syntax for `randomize()...with` is:

<pre style="margin: 0;"> blocking_assignment ::= // from Annex A.6.2 ... class_variable_identifier . randomize [()] with constraint_block </pre>	<div style="border: 1px solid black; padding: 2px; margin-bottom: 2px;">LRM 248</div> <div style="border: 1px solid black; padding: 2px; margin-bottom: 2px;">LRM 59</div> <div style="border: 1px solid black; padding: 2px;">LRM 117</div>
<pre style="margin: 0;"> inline_constraint_declaration ::= // not in Annex A class_variable_identifier . randomize [([variable_identifier_list null])] with { { constraint_block } } </pre>	

Syntax 12-9—In-line constraint syntax (except from not in Annex A)

LRM 248

`class_variable_identifier` is the name of an instantiated object.

The unnamed *constraint_block* contains additional in-line constraints to be applied along with the object constraints declared in the class.

For example:

```

class SimpleSum
  rand bit [7:0] x, y, z;
  constraint c {z == x + y;}
endclass

task InlineConstraintDemo(SimpleSum p);
  int success;
  success = p.randomize() with {x < y;};
endtask

```

This is the same example used before, however, `randomize()...with` is used to introduce an additional constraint that `x < y`.

The `randomize()...with` construct can be used anywhere an expression can appear. The constraint block following `with` can define all of the same constraint types and forms as would otherwise be declared in a class.

The `randomize()...with` constraint block can also reference local variables and task and function arguments, eliminating the need for mirroring a local state as member variables in the object class. The scope for variable names in a constraint block, from inner to outer, is: `randomize()...with` object class, automatic and local variables, task and function arguments, class variables, variables in the enclosing scope. The `randomize()...with` class is brought into scope at the innermost nesting level.

In the example below, the `randomize()...with` class is `Foo`.

```
class Foo;
```

```

    rand integer x;
endclass

class Bar;
    integer x;
    integer y;

    task doit(Foo f, integer x, integer z);
        int result;
        result = f.randomize() with {x < y + z;};
    endtask
endclass

```

In the `f.randomize()` **with** constraint block, `x` is a member of class `Foo`, and hides the `x` in class `Bar`. It also hides the `x` argument in the `doit()` task. `y` is a member of `Bar`. `z` is a local argument.

12.7 Disabling random variables with `rand_mode()`

The `rand_mode()` method can be used to control whether a random variable is active or inactive. When a random variable is inactive, it is treated the same as if it had not been declared **rand** or **randc**. Inactive variables are not randomized by the `randomize()` method, and their values are treated as state variables by the solver. All random variables are initially active.

The syntax for the `rand_mode()` method is:

```
task object[.random_variable]::rand_mode( bit on_off );
```

or

```
function int object.random_variable::rand_mode();
```

object is any expression that yields the object handle in which the random variable is defined.

random_variable is the name of the random variable to which the operation is applied. If it is not specified (only allowed when called as a task), the action is applied to all random variables within the specified object.

When called as a task, the argument to the `rand_mode` method determines the operation to be performed:

Table 12-1: `rand_mode` argument

Value	Meaning	Description
0	OFF	Sets the specified variables to inactive so that they are not randomized on subsequent calls to the <code>randomize()</code> method.
1	ON	Sets the specified variables to active so that they are randomized on subsequent calls to the <code>randomize()</code> method.

For array variables, `random_variable` can specify individual elements using the corresponding index. Omitting the index results in all the elements of the array being affected by the call.

If the random variable is an object handle, only the mode of the variable is changed, not the mode of random variables within that object (see global constraints in Section 12.4.8).

A compiler error shall be issued if the specified variable does not exist within the class hierarchy or it exists but is not declared as **rand** or **randc**.

When called as a function, `rand_mode()` returns the current active state of the specified random variable. It

returns 1 if the variable is active (ON), and 0 if the variable is inactive (OFF).

The function form of `rand_mode()` only accepts singular variables, thus, if the specified variable is an unpacked array, a single element must be selected via its index.

Example:

```
class Packet;
    rand integer source_value, dest_value;
    ... other declarations
endclass

int ret;
Packet packet_a = new;
// Turn off all variables in object
packet_a.rand_mode(0);

// ... other code
// Enable source_value
packet_a.source_value.rand_mode(1);

ret = packet_a.dest_value.rand_mode();
```

This example first disables all random variables in the object `packet_a`, and then enables only the `source_value` variable. Finally, it sets the `ret` variable to the active status of variable `dest_value`.

The `rand_mode()` method is built-in and cannot be overridden.

12.8 Controlling constraints with `constraint_mode()`

The `constraint_mode()` method can be used to control whether a constraint is active or inactive. When a constraint is inactive, it is not considered by the `randomize()` method. All constraints are initially active.

The syntax for the `constraint_mode()` method is:

```
task object[.constraint_identifier]::constraint_mode( bit on_off );
```

or

```
function int object.constraint_identifier::constraint_mode();
```

object is any expression that yields the object handle in which the constraint is defined.

constraint_identifier is the name of the constraint block to which the operation is applied. The constraint name can be the name of any constraint block in the class hierarchy. If no constraint name is specified (only allowed when called as a task), the operation is applied to all constraints within the specified object.

When called as a task, the argument to the `constraint_mode` task method determines the operation to be performed:

Table 12-2: `constraint_mode` argument

Value	Meaning	Description
0	OFF	Sets the specified constraint block to inactive so that it is not enforced by subsequent calls to the <code>randomize()</code> method.

Table 12-2: constraint_mode argument

Value	Meaning	Description
1	ON	Sets the specified constraint block to active so that it is considered on subsequent calls to the <code>randomize()</code> method.

A compiler error shall be issued if the specified constraint block does not exist within the class hierarchy.

When called as a function, `constraint_mode()` returns the current active state of the specified constraint block. It returns 1 if the constraint is active (ON), and 0 if the constraint is inactive (OFF).

Example:

```

class Packet;
    rand integer source_value;
    constraint filter1 { source_value > 2 * m; }
endclass

function integer toggle_rand( Packet p );
    if ( p.filter1.constraint_mode() )
        p.filter1.constraint_mode(0);
    else
        p.filter1.constraint_mode(1);

    toggle_rand = p.randomize();
endfunction

```

In this example, the `toggle_rand` function first checks the current active state of the constraint `filter1` in the specified `Packet` object `p`. If the constraint is active, **then** the function **shall** deactivate it; if it is inactive, the function **shall** activate it. Finally, the function calls the `randomize` method to generate a new random value for variable `source_value`.

LRM 252

The `constraint_mode()` method is built-in and cannot be overridden.

12.9 Dynamic constraint modification

There are several ways to dynamically modify randomization constraints:

- Implication and `if...else` style constraints allow declaration of predicated constraints.
- Constraint blocks can be made active or inactive using the `constraint_mode()` built-in method. Initially, all constraint blocks are active. Inactive constraints are ignored by the `randomize()` function.
- Random variables can be made active or inactive using the `rand_mode()` built-in method. Initially, all `rand` and `randc` variables are active. Inactive variables are ignored by the `randomize()` function.
- The weights in a `dist` constraint can be changed, affecting the probability that particular values in the set are chosen.

12.10 In-line random variable control

LRM 63

The `randomize()` method can be used to temporarily control the set of random and state variables within a class instance or object. When the `randomize` method is called with no arguments, it behaves as described in the previous sections, that is, it assigns new values to all random variables in an object—those declared as `rand` or `randc`—such that all of the constraints are satisfied. When `randomize` is called with arguments, those arguments designate the complete set of random variables within that object; all other variables in the object are considered state variables. For example, consider the following class and calls to `randomize`:

```

class CA;
  rand byte x, y;
  byte v, w;

  constraint c1 { x < v && y > w };
endclass

CA a = new;

a.randomize();           // random variables: x, y state variables: v, w
a.randomize( x );       // random variables: x state variables: y, v, w
a.randomize( v, w );    // random variables: v, w state variables: x, y
a.randomize( w, x );    // random variables: w, x state variables: y, v

```

LRM 252

This mechanism controls the set of active random variables for the duration of the call to `randomize`, which is conceptually equivalent to making a set of calls to the `rand_mode()` method to disable or enable the corresponding random variables. Calling `randomize()` with arguments allows changing the random mode of any class property, even those not declared as `rand` or `randc`. This mechanism, however, does not affect the cyclical random mode; it cannot change a non-random variable into a cyclical random variable (`randc`), and cannot change a cyclical random variable into a non-cyclical random variables (change from `randc` to `rand`).

The scope of the arguments to the `randomize` method is the object class. Arguments are limited to the names of properties of the calling object; expressions are not allowed. The random mode of local class members can only be changed when the call to `randomize` has access to those properties, that is, within the scope of the class in which the local members are declared.

12.10.1 In-line constraint checker

Normally, calling the `randomize` method of a class that has no random variables causes the method to behave as a checker, that is, it assigns no random values, and only returns a status: one if all constraints are satisfied and zero otherwise. The in-line random variable control mechanism can also be used to force the `randomize()` method to behave as a checker.

The `randomize` method accepts the special argument `null` to indicate no random variables for the duration of the call. That is, all class members behave as state variables. This causes the `randomize` method to behave as a checker instead of a generator. A checker evaluates all constraints and simply returns one if all constraints are satisfied, and zero otherwise. For example, if class `CA` defined above executes the following call:

```
success = a.randomize( null ); // no random variables
```

Then the solver considers all variables as state variables and only checks whether the constraint is satisfied, namely, that the relation $(x < v \ \&\& \ y > w)$ is true using the current values of `x`, `y`, `v`, and `w`.

12.11 Randomization of scope variables — `std::randomize()`

LRM 115

LRM 63

The built-in class `randomize` method operates exclusively on class member variables. Using classes to model the data to be randomized is a powerful mechanism that enables the creation of generic, reusable objects containing random variables and constraints that can be later extended, inherited, constrained, overridden, enabled, disabled, merged with or separated from other objects. The ease with which classes and their associated random variables and constraints can be manipulated make classes an ideal vehicle for describing and manipulating random data and constraints. However, some less-demanding problems that do not require the full flexibility of classes, can use a simpler mechanism to randomize data that does not belong to a class. The scope `randomize` ~~method~~ `function`, `std::randomize()`, enables users to randomize data in the current scope, without the need to define a class or instantiate a class object.

LRM 254

The syntax of the scope `randomize` ~~method~~ `function` is:

```

statement ::= [ block_identifier : ] { attribute_instance } statement_item  // from Annex A.6.4
statement_item ::=
    ...
    † scope_randomize
scope_randomize ::= [ std:: ] randomize ( [ variable_identifier_list ] ) [ with { constraint_block } ]
variable_identifier_list ::= variable_identifier { , variable_identifier }
scope_randomize ::= // not in Annex A
    [ std:: ] randomize ( [ variable_identifier_list ] ) [ with { { constraint_block } } ]

```

LRM 248

LRM 115

Syntax 12-10—scope randomize *method function* syntax (*excerpt from not in Annex A*)

LRM 248
LRM 254

The scope randomize *method function* behaves exactly the same as a class randomize method, except that it operates on the variables of the current scope instead of class member variables. Arguments to this *method function* specify the variables that are to be assigned random values, i.e., the random variables.

LRM 254

For example:

```

module stim;
    bit [15:0] addr;
    bit [31:0] data;

    function bit gen_stim();
        bit success, rd_wr;

        success = randomize( addr, data, rd_wr ); // call std::randomize
        return rd_wr ;
    endfunction

    ...
endmodule

```

LRM 115

The function gen_stim calls std::randomize() with three variables as arguments: addr, data, and rd_wr. Thus, std::randomize() assigns new random variables to those variables that are visible in the scope of the gen_stim function. Note that addr and data have module scope, whereas rd_wr has scope local to the function. The above example can also be written using a class:

```

class stimc;
    rand bit [15:0] addr;
    rand bit [31:0] data;
    rand bit rd_wr;
endclass

function bit gen_stim( stimc p );
    bit success;
    success = p.randomize();
    addr = p.addr;
    data = p.data;
    return p.rd_wr;
endfunction

```

However, for this simple application, the scope randomize *method function* leads to a straightforward implementation.

LRM 254

The scope randomize *method function* returns 1 if it successfully sets all the random variables to valid values, otherwise it returns 0. If the scope randomize *method function* is called with no arguments then it behaves as a

checker, and simply returns status.

12.11.1 Adding constraints to scope variables - `std::randomize()` with

The `std::randomize()` **with** form of the scope `randomize` **method function** allows users to specify random constraints to be applied to the local scope variables. When specifying constraints, the arguments to the scope `randomize` **method function** become random variables, all other variables are considered state variables.

LRM 252
LRM 254

```
task stimulus( int length );
    int a, b, c, success;

    success = std::randomize( a, b, c ) with { a < b ; a + b < length };
    ...
    success = std::randomize( a, b ) with { b - a > length };
    ...
endtask
```

The task `stimulus` above calls `std::randomize` twice resulting in two sets of random values for its local variables `a`, `b`, and `c`. In the first call variables `a` and `b` are constrained such that variable `a` is less than `b`, and their sum is less than the task argument `length`, which is designated as a state variable. In the second call, variables `a` and `b` are constrained such that their difference is greater than state variable `length`.

12.12 Random number system functions and methods

LRM 63

12.12.1 `$urandom`

The system function `$urandom` provides a mechanism for generating pseudorandom numbers. The function returns a new 32-bit random number each time it is called. The number shall be unsigned.

The syntax for `$urandom` is:

```
function int unsigned $urandom [ (int seed) ] ;
```

The `seed` is an optional argument that determines the sequence of random numbers generated. The seed can be any integral expression. The random number generator shall generate the same sequence of random numbers every time the same seed is used.

The random number generator is deterministic. Each time the program executes, it cycles through the same random sequence. This sequence can be made nondeterministic by seeding the `$urandom` function with an extrinsic random variable, such as the time of day.

For example:

```
bit [64:1] addr;

$urandom( 254 );           // Initialize the generator
addr = {$urandom, $urandom }; // 64-bit random number
number = $urandom & 15;    // 4-bit random number
```

The `$urandom` function is similar to the `$random` system function, with two exceptions. `$urandom` returns unsigned numbers and is automatically thread stable (see Section 12.13.2).

12.12.2 `$urandom_range()`

The `$urandom_range()` function returns an unsigned integer within a specified range.

The syntax for `$urandom_range()` is:

```
function int unsigned $urandom_range( int unsigned maxval,
                                     int unsigned minval = 0 );
```

The function shall return an unsigned integer in the range maxval ... minval.

Example: val = \$urandom_range(7,0);

If minval is omitted, the function shall return a value in the range maxval ... 0.

Example: val = \$urandom_range(7);

If maxval is less than minval, the arguments are automatically reversed so that the first argument is larger than the second argument.

Example: val = \$urandom_range(0,7);

All of the three previous examples produce a value in the range of 0 to 7, inclusive.

\$urandom_range() is automatically thread stable (see Section 12.13.2).

12.12.3 srandom()

LRM 63

The `srandom()` method allows manually seeding the Random Number Generator (RNG) of objects or threads. The RNG of a process can be seeded using the `srandom()` method of the process (see Section 9.9).

The prototype of the `srandom()` method is:

```
function void srandom( int seed );
```

The `srandom()` method initializes an object's random number generator using the value of the given seed.

12.12.4 get_randstate()

LRM 63

The `get_randstate()` method retrieves the current state an object's Random Number Generator (RNG). The state of the RNG associated with a process is retrieved using the `get_randstate()` method of the process (see Section 9.9).

The prototype of the `get_randstate()` method is:

```
function string get_randstate();
```

The `get_randstate()` method returns a copy of the internal state of the RNG associated with the given object.

The RNG state is a string of unspecified length and format. The length and contents of the string are implementation dependent.

12.12.5 set_randstate()

LRM 63

The `set_randstate()` method sets the state of an object's Random Number Generator (RNG). The state of the RNG associated with a process is set using the `set_randstate()` method of the process (see Section 9.9).

The prototype of the `set_randstate()` method is:

```
function void set_randstate( string state );
```

The `set_randstate()` method copies the given state into the internal state of an object's RNG.

The RNG state is a string of unspecified length and format. Calling `set_randstate()` with a string value that was not obtained from `get_randstate()`—or from a different implementation of

`get_randstate()`—is undefined.

12.13 Random stability

The Random Number Generator (RNG) is localized to threads and objects. Because the sequence of random values returned by a thread or object is independent of the RNG in other threads or objects, this property is called *random stability*. Random stability applies to:

- The system randomization calls, `$urandom()` and `$urandom_range()`, ~~and `$srandom()`.~~
- The object and process random seeding method, `srandom()`.
- The object randomization method, `randomize()`.

LRM 252

Testbenches with this feature exhibit more stable RNG behavior in the face of small changes to the user code. Additionally, it enables more precise control over the generation of random values by manually seeding threads and objects.

12.13.1 Random stability properties

Random stability encompasses the following properties:

— Thread stability

Each thread has an independent RNG for all randomization system calls invoked from that thread. When a new thread is created, its RNG is seeded with the next random value from its parent thread. This property is called *hierarchical seeding*.

Program and thread stability is guaranteed as long as thread creation and random number generation is done in the same order as before. When adding new threads to an existing test, they can be added at the end of a code block in order to maintain random number stability of previously created work.

— Object stability

Each class instance (object) has an independent RNG for all randomization methods in the class. When an object is created using `new`, its RNG is seeded with the next random value from the thread that creates the object.

Object stability is guaranteed as long as object and thread creation, as well as random number generation, are done in the same order as before. In order to maintain random number stability, new objects, threads and random numbers can be created after existing objects are created.

— Manual seeding

All RNG's can be manually seeded. Combined with hierarchical seeding, this facility allows users to define the operation of a subsystem (hierarchy subtree) completely with a single seed at the root thread of the system.

12.13.2 Thread stability

Random values returned from the `$urandom` system call are independent of thread execution order. For example:

```
integer x, y, z;
fork //set a seed at the start of a thread
  begin $process::self.srandom(100); x = $urandom; end
  //set a seed during a thread
  begin y = $urandom; $process::self.srandom(200); end
  // draw 2 values from the thread RNG
  begin z = $urandom + $urandom ; end
join join
```

LRM 252

The above program fragment illustrates several properties:

- Thread locality. The values returned for `x`, `y` and `z` are independent of the order of thread execution. This is an important property because it allows development of subsystems that are independent, controllable, and predictable.
- Hierarchical seeding. When a thread is created, its random state is initialized using the next random value from the parent thread as a seed. The three forked threads are all seeded from the parent thread.

Each thread is seeded with a unique value, determined solely by its parent. The root of a thread execution subtree determines the random seeding of its children. This allows entire subtrees to be moved, and preserves their behavior by manually seeding their root thread.

12.13.3 Object stability

The `randomize()` method built into every class exhibits object stability. This is the property that calls to `randomize()` in one instance are independent of calls to `randomize()` in other instances, and independent of calls to other randomize functions.

For example:

```
class Foo;
    rand integer x;
endclass

class Bar;
    rand integer y;
endclass

initial begin
    Foo foo = new();
    Bar bar = new();
    integer z;
    void' (foo.randomize());
    // z = $random;
    void' (bar.randomize());
end
```

LRM 108

- The values returned for `foo.x` and `bar.y` are independent of each other.
- The calls to `randomize()` are independent of the `$random` system call. If one uncomments the line `z = $random` above, there is no change in the values assigned to `foo.x` and `bar.y`.
- Each instance has a unique source of random values that can be seeded independently. That random seed is taken from the parent thread when the instance is created.
- Objects can be seeded at any time using the `$srandom()` ~~system task with an optional object argument~~ `.method`.

LRM 252

```
class Foo;
    function new (integer seed);
        //set a new seed for this instance
        $this.srandom(seed, this);
    endfunction
endclass
```

Once an object is created there is no guarantee that the creating thread can change the object's random state before another thread accesses the object. Therefore, it is best that objects self-seed within their `new` method rather than externally.

An object's seed can be set from any thread. However, a thread's seed can only be set from within the thread itself.

12.14 Manually seeding randomize

Each object maintains its own internal random number generator, which is used exclusively by its `randomize()` method. This allows objects to be randomized independent of each other and of calls to other system randomization functions. When an object is created, its random number generator (RNG) is seeded using the next value from the RNG of the thread that creates the object. This process is called *hierarchical object seeding*.

Sometimes it is desirable to manually seed an object's RNG using the `$srandom()` **system-call** method. This can be done either in a class method, or external to the class definition:

LRM 252

An example of seeding the RNG internally, as a class method is:

```
class Packet;
  rand bit[15:0] header;
  ...
  function new (int seed);
    $this.srandom(seed, this);
    ...
  endfunction
endclass
```

An example of seeding the RNG externally is:

```
Packet p = new(200); // Create p with seed 200.
$p.srandom(300, p); // Re-seed p with seed 300.
```

Calling `$srandom()` in an object's `new()` function, assures the object's RNG is set with the new seed before any class member values are randomized.

12.15 Random weighted case — randcase

LRM 30

```
statement_item ::= //from Annex A.6.4
  ...
  | randcase_statement
randcase_statement ::= //from Annex A.6.7
  randcase randcase_item { randcase_item } endcase
randcase_item ::= expression : statement_or_null
```

LRM 66

Syntax 12-11—randcase syntax (excerpt from Annex A)

The keyword `randcase` introduces a case statement that randomly selects one of its branches. The `randcase` item expressions are non-negative integral values that constitute the branch weights. An item's weight divided by the sum of all weights gives the probability of taking that branch. For example:

```
randcase
  3 : x = 1;
  1 : x = 2;
  4 : x = 3;
endcase
```

The sum of all weights is 8, so the probability of taking the first branch is 0.375, the probability of taking the second is 0.125, and the probability of taking the third is 0.5.

If a branch specifies a zero weight then that branch is not taken. If all randcase items specify zero weights then no branch is taken and a warning can be issued.

The randcase weights can be arbitrary expressions, not just constants. For example:

```
byte a, b;

randcase
  a + b : x = 1;
  a - b : x = 2;
  a ^ ~b : x = 3;
  12'b800 : x = 4;
endcase
```

The precision of each weight expression is self-determined. The sum of the weights is computed using standard addition semantics (maximum precision of all weights), where each summand is unsigned. Each weight expression is evaluated at most once (implementations can cache identical expressions) in an unspecified order. In the example above, the first three weight expressions are computed using 8-bit precision, the fourth expression is computed using 12-bit precision; the resulting weights are added as unsigned values using 12-bit precision. The weight selection then uses unsigned 12-bit comparison.

Each call to **randcase** retrieves one random number in the range zero to the sum of the weights. The weights are then selected in declaration order: smaller random numbers correspond to the first (top) weight statements.

Randcase statements exhibit thread stability. The random numbers are obtained from \$urandom_range, thus, random values drawn are independent of thread execution order.

12.16 Random sequence generation — randsequence

LRM 62
LRM 66

Parser generators, such as yacc, use a Backus-Naur Form (BNF) or similar notation to describe the grammar of the language to be parsed. The grammar is thus used to generate a program that is able to check if a stream of tokens represents a syntactically correct utterance in that language. SystemVerilog's sequence generator reverses this process. It uses the grammar to randomly create a correct utterance (i.e., a stream of tokens) of the language described by the grammar. The random sequence generator is useful for randomly generating structured sequences of stimulus such as instructions or network traffic patterns.

The sequence generator uses a set of rules and productions within a **randsequence** block. The syntax of the **randsequence** block is:

```

statement_item ::= // from Annex A.6.4
    ...
    | randsequence_statement
randsequence_statement ::= randsequence ( ( [ production_identifier ] ) // from Annex A.6.12
    production { production }
    endsequence
production ::= [ function_data_type ] production_name ( ( tf_port_list ) ) : rs_rule { | rs_rule } ;
rs_rule ::= rs_production_list [ := expression [ rs_code_block ] ]
rs_production_list ::=
    rs_prod { rs_prod }
    | rand join [ ( expression ) ] production_item production_item { production_item }
rs_code_block ::= { { data_declaration } { statement_or_null } }
rs_prod ::=
    production_item
    | rs_code_block
    | rs_if_else
    | rs_repeat
    | rs_case
production_item ::= production_identifier [ ( list_of_arguments ) ]
rs_if_else ::= if ( expression ) production_item [ else production_item ]
rs_repeat ::= repeat ( expression ) production_item
rs_case ::= case ( expression ) rs_case_item { rs_case_item } endcase
rs_case_item ::=
    expression { , expression } : production_item
    | default [ : ] production_item

```

Syntax 12-12—randsequence syntax (excerpt from Annex A)

A **randsequence** grammar is composed of one or more productions. Each production contains a name and a list of production items. Production items are further classified into terminals and nonterminals. Nonterminals are defined in terms of terminals and other nonterminals. A terminal is an indivisible item that needs no further definition than its associated code block. Ultimately, every nonterminal is decomposed into its terminals. A production list contains a succession of production items, indicating that the items must be streamed in sequence. A single production can contain multiple production lists separated by the | symbol. Production lists separated by a | imply a set of choices, which the generator will make at random.

A simple example illustrates the basic concepts:

```

randsequence ( main )
    main      : first second done ;
    first     : add | dec ;
    second    : pop | push ;
    done      : { $display("done"); } ;
    add       : { $display("add"); } ;
    dec       : { $display("dec"); } ;
    pop       : { $display("pop"); } ;
    push      : { $display("push"); } ;
endsequence

```

The production main is defined in terms of three nonterminals: first, second, and done. When main is chosen, it generates the sequence, first, second, and done. When first is generated, it is decomposed into

its productions, which specifies a random choice between `add` and `dec`. Similarly, the second production specifies a choice between `pop` and `push`. All other productions are terminals; they are completely specified by their code block, which in the example displays the production name. Thus, the grammar leads to the following possible outcomes:

```
add pop done
add push done
dec pop done
dec push done
```

When the `randsequence` statement is executed, it generates a grammar-driven stream of random productions. As each production is generated, the side effects of executing its associated code blocks produce the desired stimulus. In addition to the basic grammar, the sequence generator provides for random weights, interleaving and other control mechanisms. Although the `randsequence` statement does not intrinsically create a loop, a recursive production will cause looping.

The `randsequence` statement creates an automatic scope. All production identifiers are local to the scope. In addition, each code block within the `randsequence` block creates an anonymous automatic scope. Hierarchical references to the variables declared within the code blocks are not allowed. To declare a static variable, the static prefix must be used. The `randsequence` keyword can be followed by an optional production name (inside the parenthesis) that designates the name of the top-level production. If unspecified, the first production becomes the top-level production.

12.16.1 Random production weights

The probability that a production list is generated can be changed by assigning weights to production lists. The probability that a particular production list is generated is proportional to its specified weight.

```
production ::= [ function_data_type ] production_name ( ( tf_port_list ) ) : rs_rule { | rs_rule } ;
rs_rule ::= rs_production_list [ := expression [ rs_code_block ] ]
```

The `:=` operator assigns the weight specified by the expression to its production list. Weight expression must evaluate to integral non-negative values. A weight is only meaningful when assigned to alternative productions, that is, production list separated by a `|`. Weight expressions are evaluated when their enclosing production is selected, thus allowing weights to change dynamically. For example, the `first` production of the previous example can be re-written as:

```
first : add := 3
      | dec := 2
      ;
```

This defines the production `first` in terms of two weighted production lists `add` and `dec`. The production `add` will be generated with 60% probability and the production `dec` will be generated with 40% probability.

If no weight is specified, a production shall use a weight of 1. If only some weights are specified, the unspecified weights shall use a weight of 1.

12.16.2 If...else production statements

A production can be made conditionally by means of an `if...else` production statement. The syntax of the `if...else` production statement is:

```
rs_if_else ::= if ( expression ) production_item [ else production_item ]
```

The expression can be any expression that evaluates to a boolean value. If the expression evaluates to true, the production following the expression is generated, otherwise the production following the optional else state-

ment is generated. For example:

```

randsequence ()
  ...
  PP_PO : if ( depth < 2 ) PUSH else POP ;
  PUSH : { ++depth; do_push(); };
  POP   : { --depth; do_pop(); };
endsequence

```

This example defines the production PP_OP. If the variable depth is less than 2 then production PUSH is generated, otherwise production POP is generated. The variable depth is updated by the code blocks of both the PUSH and POP productions.

12.16.3 Case production statements

A production can be selected from a set of alternatives using a **case** production statement. The syntax of the **case** production statement is:

```

rs_case ::= case ( expression ) rs_case_item { rs_case_item } endcase
rs_case_item ::=
    expression { , expression } : production_item
    | default [ : ] production_item

```

The case production statement is analogous to the procedural case statement except as noted below. The case expression is evaluated, and its value is compared against the value of each case-item expression, which are evaluated and compared in the order in which they are given. The production **generated is the one** associated with the first case-item expression **that matches matching** the case expression **is generated**. If no matching case-item expression is found then the production associated with the optional default item is generated, or nothing if there no default item. Multiple default statements in one case production statement shall be illegal. Case-item expressions separated by commas allow multiple expressions to share the production. For example:

LRM 256

```

randsequence ()
  SELECT : case ( device & 7 )
    0      : NETWORK
    1, 2   : DISK
    default : MEMORY
  endcase ;
  ...
endsequence

```

This example defines the production SELECT with a **case** statement. The case expression (device & 7) is evaluated and compared against the two case-item expressions. If the expression matches 0, the production NETWORK is generated, and if it matches 1 or 2 the production DISK is generated. Otherwise the production MEMORY is generated.

12.16.4 Repeat production statements

The **repeat** production statement is used to iterate over a production a specified number of times. The syntax of the **repeat** production statement is:

```

rs_repeat ::= repeat ( expression ) production_item

```

The **repeat** expression must evaluate to a non-negative integral value. That value specifies the number of times that the corresponding production is generated. For example:

```

randsequence ()

```

```

...
PUSH_OPER : repeat( $urandom_range( 2, 6 ) ) PUSH ;
PUSH      : ...
endsequence

```

In this example the `PUSH_OPER` production specifies that the `PUSH` production be repeated a random number of times (between 2 and 6) depending on by the value returned by `$urandom_range()`.

The `repeat` production statement itself cannot be terminated prematurely. A `break` statement will terminate the entire `randsequence` block (see Section 12.16.6).

LRM 164

12.16.5 Interleaving productions — `rand join`

The `rand join` production control is used to randomly interleave two or more production sequences while maintaining the relative order of each sequence. The syntax of the `rand join` production control is:

```

rs_production_list ::=
    rs_prod { rs_prod }
    | rand join [ ( expression ) ] production_item production_item { production_item }

```

For example:

```

randsequence( TOP )
    TOP : rand join S1 S2 ;
    S1  : A B ;
    S2  : C D ;
endsequence

```

The generator will randomly produce the following sequences:

```

A B C D
A C B D
A C D B
C D A B
C A B D
C A D B

```

The optional expression following the `rand join` keywords must be a real number in the range 0.0 to 1.0. The value of this expression represents the degree to which the length of the sequences to be interleaved affects the probability of selecting a sequence. A sequence's length is the number of productions not yet interleaved at a given time. If the expression is 0.0, the shortest sequences are given higher priority. If the expression is 1.0, the longest sequences are given priority. For instance, using the previous example:

```

TOP : rand join (0.0) S1 S2 ;

```

Gives higher priority to the sequences: A B C D C D A B

```

TOP : rand join (1.0) S1 S2 ;

```

Gives higher priority to the sequences: A C B D A C D B C A B D C A D B

If unspecified, the generator used the default value of 0.5, which does not prioritize any sequence length.

At each step, the generator interleaves nonterminal symbols to depth of one.

12.16.6 Aborting productions — `break` and `return`

Two procedural statements can be used to terminate a production prematurely: `break` and `return`. These two

statements can appear in any code block; they differ in what they consider the scope from which to exit.

The **break** statement terminates the sequence generation. When a **break** statement is executed from within a production code block, it forces a jump out of the **randsequence** block. For example:

```

randsequence (
    WRITE      : SETUP DATA ;
    SETUP     : { if( fifo_length >= max_length ) break; } COMMAND ;
    DATA     : ...
endsequence
next_statement : ...

```

When the example above executes the **break** statement within the **SETUP** production, the **COMMAND** production is not generated, and execution continues on the line labeled `next_statement`. Use of the **break** statement within a loop statement behaves as defined in Section 8.6. Thus, the **break** statement terminates the smallest enclosing loop statement, otherwise the **randsequence** block.

The **return** statement aborts the generation of the current production. When a **return** statement is executed from within a production code block, the current production is aborted. Sequence generation continues with the next production following the aborted production. For example:

```

randsequence (
    TOP : P1 P2 ;
    P1  : A B C ;
    P2  : A { if( flag == 1 ) return; } B C ;
    A   : { $display( "A" ); } ;
    B   : { if( flag == 2 ) return; $display( "B" ); } ;
    C   : { $display( "C" ); } ;
endsequence

```

Depending on the value of variable `flag`, the example above displays the following:

```

flag == 0 ==> A B C A B C
flag == 1 ==> A B C A
flag == 2 ==> A C A C

```

When `flag == 1`, production `P2` is aborted in the middle, after generating `A`. When `flag == 2`, production `B` is aborted twice (once as part of `P1` and once as part of `P2`), but each time, generation continues with the next production, `C`.

12.16.7 Value passing between productions

Data can be passed down to a production about to be generated, and generated productions can return data to the nonterminals that triggered their generation. Passing data to a production is similar to a task call, and uses the same syntax. Returning data from a production requires that a type be declared for the production, which uses syntax similar to a function declaration.

Productions that accept data include a formal argument list. The syntax for declaring the arguments to a production is similar to a task prototype; the syntax for passing data to the production is the same as a task call.

```

production ::= [ function_data_type ] production_name [ ( tf_port_list ) ] : rs_rule { | rs_rule } ;
production_item ::= production_identifier [ ( list_of_arguments ) ]

```

For example, the first example above could be written as:

```

randsequence( main )
    main                : first second gen ;
    first               : add | dec ;
    second              : pop | push ;

```

```

    add          : gen("add") ;
    dec          : gen("dec") ;
    pop          : gen("pop") ;
    push        : gen("push") ;
    gen( string s = "done" ) : { $display( s ); } ;
endsequence

```

In this example, the production `gen` accepts a string argument whose default is "done". Five other productions generate this production, each with a different argument (the one in `main` uses the default).

A production creates a scope, which encompasses all its rules and code blocks. Thus, arguments passed down to a production are available throughout the production.

Productions that return data require a type declaration. The optional return type precedes the production. Productions that do not specify a return type shall assume a void return type.

A value is returned from a production by using the `return` with an expression. When the `return` statement is used with a production that returns a value, it must specify an expression of the correct type, just like non-void functions. The `return` statement assigns the given expression to the corresponding production. The return value can be read in the code blocks of the production that triggered the generation of the production returning a value. Within these code blocks, return values are accessed using the production name plus an optional indexing expression. Within each production, a variable of the same name is implicitly declared for each production that returns a value.

If the same production appears multiple times then a one-dimensional array that starts at 1 is implicitly declared. For example:

```

randsequence( bin_op )
    void bin_op      : value operator value // void type is optional
                    { $display( "%s %b %b", operator, value[1], value[2] ); }
                    ;
    bit [7:0] value  : { return $urandom } ;
    string operator  : add := 5 { return "+" ; }
                    | dec := 2 { return "-" ; }
                    | mult := 1 { return "*" ; }
                    ;
endsequence

```

In the example above, the `operator` and `value` productions return a string and an 8-bit value, respectively. The production `bin_op` includes these two value-returning productions. Therefore, the code block associated with production `bin_op` has access to the following implicit variable declarations:

```

bit [7:0] value [1:2];
string operator;

```

Accessing these implicit variables yields the values returned from the corresponding productions. When executed, the example above displays a simple three-item random sequence: an operator followed by two 8-bit values. The operators `+`, `-`, and `*` are chosen with a distribution of 5/8, 2/8, and 1/8, respectively.

Only the return values of productions already generated (i.e., to the left of the code block accessing them) can be retrieved. Attempting to read the return value of a production that has not been generated results in an undefined value. For example:

```

X : A {int y = B;} B ; // invalid use of B
X : A {int y = A[2];} B A ; // invalid use of A[2]
X : A {int y = A;} B {int j = A + B;} ; // valid

```

The sequences produced by `randsequence` can be driven directly into a system, as a side effect of production generation, or the entire sequence can be generated for future processing. For example, the following function

generates and returns a queue of random numbers in the range given by its arguments. The first and last queue item correspond to the lower and upper bounds, respectively. Also, the size of the queue is randomly selected based on the production weights.

```
function int[$] GenQueue(int low, int high);
    int[$] q;

    randsequence()
        TOP      : BOUND(low) LIST BOUND(high) ;
        LIST     : LIST ITEM:= 8   { q = { q, ITEM }; }
                  | ITEM       := 2   { q = { q, ITEM }; }
                  ;
        int ITEM : { return $urandom_range( low, high ); } ;

        BOUND(int b) : { q = { q, b }; } ;
    endsequence
    GenQueue = q;
endfunction
```

When the **randsequence** in function `GenQueue` executes, it generates the `TOP` production, which causes three productions to be generated: `BOUND` with argument `low`, `LIST`, and `BOUND` with argument `high`. The `BOUND` production simply appends its argument to the queue. The `LIST` production consists of a weighted `LIST ITEM` production and an `ITEM` production. The `LIST ITEM` production is generated with 80% probability, which causes the `LIST` production to be generated recursively, thereby postponing the generation of the `ITEM` production. The selection between `LIST ITEM` and `ITEM` is repeated until the `ITEM` production is selected, which terminates the `LIST` production. Each time the `ITEM` production is generated, it produces a random number in the indicated range, which is later appended to the queue.

The following example uses a **randsequence** block to produce random traffic for a DSL packet network.

```
class DSL; ... endclass // class that creates valid DSL packets

    randsequence (STREAM)
        STREAM : GAP DATA := 80
                | DATA    := 20 ;

        DATA : PACKET(0) := 94 { transmit( PACKET ); }
                | PACKET(1) := 6 { transmit( PACKET ); } ;

        DSL PACKET (bit bad) : { DSL d = new;
                                if( bad ) d.crc ^= 23; // mangle crc
                                return d;
                            } ;

        GAP: { ## { $urandom_range( 1, 20 ) }; } ;
    endsequence
```

LRM 275

In this example, the traffic consists of a stream of (good and bad) data packets and gaps. The first production, `STREAM`, specifies that 80% of the time the traffic consists of a `GAP` followed by some `DATA`, and 20% of the time it consists of just `DATA` (no `GAP`). The second production, `DATA`, specifies that 94% of all data packets are good packets, and the remaining 6% are bad packets. The `PACKET` production implements the DSL packet creation; if the production argument is 1 then a bad packet is produced by mangling the crc of a valid DSL packet. Finally, the `GAP` production implements the transmission gaps by waiting a random number of cycles between 1 and 20.

Section 13 Inter-Process Synchronization and Communication

13.1 Introduction (informative)

High-level and easy-to-use synchronization and communication mechanism are essential to control the kinds of interactions that occur between dynamic processes used to model a complex system or a highly reactive testbench. Verilog provides basic synchronization mechanisms (i.e., `->` and `@`), but they are all limited to static objects and are adequate for synchronization at the hardware level, but fall short of the needs of a highly dynamic, reactive testbench. At the system level, an essential limitation of Verilog is its inability to create dynamic events and communication channels, which match the capability to create dynamic processes.

SystemVerilog adds a powerful and easy-to-use set of synchronization and communication mechanisms, all of which can be created and reclaimed dynamically. SystemVerilog adds a *semaphore* built-in class, which can be used for synchronization and mutual exclusion to shared resources, and a *mailbox* built-in class that can be used as a communication channel between processes. SystemVerilog also enhances Verilog's named `event` data type to satisfy many of the system-level synchronization requirements.

Semaphores and mailboxes are built-in types, nonetheless, they are classes, and can be used as base classes for deriving additional higher level classes. These built-in classes reside in the built-in std package (see Section 7.10.1), thus, they can be re-defined by user code in any other scope.

LRM 115

LRM 23

13.2 Semaphores

Conceptually, a *semaphore* is a bucket. When a semaphore is allocated, a bucket that contains a fixed number of keys is created. Processes using semaphores must first procure a key from the bucket before they can continue to execute. If a specific process requires a key, only a fixed number of occurrences of that process can be in progress simultaneously. All others must wait until a sufficient number of keys is returned to the bucket. Semaphores are typically used for mutual exclusion, access control to shared resources, and for basic synchronization.

An example of creating a semaphore is:

```
semaphore smTx;
```

Semaphore is a built-in class that provides the following methods:

- Create a semaphore with a specified number of keys: `new()`
- Obtain one or more keys from the bucket: `get()`
- Return one or more keys into the bucket: `put()`
- Try to obtain one or more keys without blocking: `try_get()`

13.2.1 new()

Semaphores are created with the `new()` method.

The prototype for semaphore `new()` is:

```
function new(int keyCount = 0 );
```

The *KeyCount* specifies the number of keys initially allocated to the semaphore bucket. The number of keys in the bucket can increase beyond *KeyCount* when more keys are put into the semaphore than are removed. The default value for *KeyCount* is 0.

The `new()` function returns the semaphore handle, or `null` if the semaphore cannot be created.

13.2.2 put()

The semaphore `put ()` method is used to return keys to a semaphore.

The prototype for `put ()` is:

```
task put(int keyCount = 1);
```

keyCount specifies the number of keys being returned to the semaphore. The default is 1.

When the `semaphore.put ()` task is called, the specified number of keys are returned to the semaphore. If a process has been suspended waiting for a key, that process shall execute if enough keys have been returned.

13.2.3 get()

The semaphore `get ()` method is used to procure a specified number of keys from a semaphore.

The prototype for `get ()` is:

```
task get(int keyCount = 1);
```

keyCount specifies the required number of keys to obtain from the semaphore. The default is 1.

If the specified number of keys are available, the method returns and execution continues. If the specified number of key are not available, the process blocks until the keys become available.

The semaphore waiting queue is First-In First-Out (FIFO). This does not guarantee the order in which processes arrive at the queue, only that their arrival order shall be preserved by the semaphore.

13.2.4 try_get()

The semaphore `try_get ()` method is used to procure a specified number of keys from a semaphore, but without blocking.

The prototype for `try_get ()` is:

```
function int try_get(int keyCount = 1);
```

keyCount specifies the required number of keys to obtain from the semaphore. The default is 1.

If the specified number of keys are available, the method returns 1 and execution continues. If the specified number of key are not available, the method returns 0.

13.3 Mailboxes

A *mailbox* is a communication mechanism that allows messages to be exchanged between processes. Data can be sent to a mailbox by one process and retrieved by another.

Conceptually, mailboxes behave like real mailboxes. When a letter is delivered and put into the mailbox, one can retrieve the letter (and any data stored within). However, if the letter has not been delivered when one checks the mailbox, one must choose whether to wait for the letter or retrieve the letter on subsequent trips to the mailbox. Similarly, SystemVerilog's mailboxes provide processes to transfer and retrieve data in a controlled manner. Mailboxes are created as having either a bounded or unbounded queue size. A bounded mailbox becomes full when it contains the bounded number of messages. A process that attempts to place a message into a full mailbox shall be suspended until enough room becomes available in the mailbox queue. Unbounded mailboxes never suspend a thread in a send operation.

An example of creating a mailbox is:

```
mailbox mbxRcv;
```

Mailbox is a built-in class that provides the following methods:

- Create a mailbox: `new()`
- Place a message in a mailbox: `put()`
- Try to place a message in a mailbox without blocking: `try_put()`
- Retrieve a message from a mailbox: `get()` or `peek()`
- Try to retrieve a message from a mailbox without blocking: `try_get()` or `try_peek()`
- Retrieve the number of messages in the mailbox: `num()`

13.3.1 new()

Mailboxes are created with the `new()` method.

The prototype for mailbox `new()` is:

```
function new(int bound = 0);
```

The `new()` function returns the mailbox handle, or `null` if the mailboxes cannot be created. If the `bound` argument is zero then the mailbox is unbounded (the default) and a `put()` operation shall never block. If `bound` is non-zero, it represents the size of the mailbox queue.

The `bound` must be positive. Negative bounds are illegal and can result in indeterminate behavior, but implementations can issue a warning.

13.3.2 num()

The number of messages in a mailbox can be obtained via the `num()` method.

The prototype for `num()` is:

```
function int num();
```

The `num()` method returns the number of messages currently in the mailbox.

The returned value should be used with care, since it is valid only until the next `get()` or `put()` is executed on the mailbox. These mailbox operations can be from different processes than the one executing the `num()` method. Therefore, the validity of the returned value shall depend on the time that the other methods start and finish.

13.3.3 put()

The `put()` method places a message in a mailbox.

The prototype for `put()` is:

```
task put(singular message);
```

The `message` is any singular expression, including object handles.

The `put()` method stores a message in the mailbox in strict FIFO order. If the mailbox was created with a bounded queue the process shall be suspended until there is enough room in the queue.

13.3.4 try_put()

The `try_put()` method attempts to place a message in a mailbox.

The prototype for `try_put()` is:

```
function int try_put( singular message );
```

The message is any singular expression, including object handles.

The `try_put()` method stores a message in the mailbox in strict FIFO order. This method is meaningful only for bounded mailboxes. If the mailbox is not full then the specified message is placed in the mailbox and the function returns 1. If the mailbox is full, the method returns 0.

13.3.5 get()

The `get()` method retrieves a message from a mailbox.

The prototype for `get()` is:

```
task get( ref singular message );
```

The message can be any singular expression, and it must be a valid left-hand side expression.

The `get()` method retrieves one message from the mailbox, that is, removes one message from the mailbox queue. If the mailbox is empty then the current process blocks until a message is placed in the mailbox. If there is a type mismatch between the *message* variable and the message in the mailbox, a runtime error is generated.

Non-parameterized mailboxes are type-less, that is, a single mailbox can send and receive different types of data. Thus, in addition to the data being sent (i.e., the message queue), a mailbox implementation must maintain the message data type placed by `put()`. This is required in order to enable the runtime type checking.

The mailbox waiting queue is FIFO. This does not guarantee the order in which processes arrive at the queue, only that their arrival order shall be preserved by the mailbox.

13.3.6 try_get()

The `try_get()` method attempts to retrieve a message from a mailbox without blocking.

The prototype for `try_get()` is:

```
function int try_get( ref singular message );
```

The *message* can be any singular expression, and it must be a valid left-hand side expression.

The `try_get()` method tries to retrieve one message from the mailbox. If the mailbox is empty, then the method returns 0. If there is a type mismatch between the *message* variable and the message in the mailbox, the method returns -1. If a message is available and the message type matches the type of the *message* variable, the message is retrieved and the method returns 1.

13.3.7 peek()

The `peek()` method copies a message from a mailbox without removing the message from the queue.

The prototype for `peek()` is:

```
task peek( ref singular message );
```

The *message* can be any singular expression, and it must be a valid left-hand side expression.

The `peek()` method copies one message from the mailbox without removing the message from the mailbox queue. If the mailbox is empty then the current process blocks until a message is placed in the mailbox. If there is a type mismatch between the *message* variable and the message in the mailbox, a runtime error is generated.

Note that calling `peek()` can cause one message to unblock more than one process. As long as a message remains in the mailbox queue, any process blocked in either a `peek()` or `get()` operation shall become unblocked.

13.3.8 try_peek()

The `try_peek()` method attempts to copy a message from a mailbox without blocking.

The prototype for `try_peek()` is:

```
function int try_peek( ref singular message );
```

The message can be any singular expression, and it must be a valid left-hand side expression.

The `try_peek()` method tries to copy one message from the mailbox without removing the message from the mailbox queue. If the mailbox is empty, then the method returns 0. If there is a type mismatch between the *message* variable and the message in the mailbox, the method returns -1. If a message is available and the message type matches, the type of the *message* variable, the message is copied and the method returns 1.

13.4 Parameterized mailboxes

The default mailbox is type-less, that is, a single mailbox can send and receive any type of data. This is a very powerful mechanism that, unfortunately, can also result in run-time errors due to type mismatches between a message and the type of the variable used to retrieve the message. Frequently, a mailbox is used to transfer a particular message type, and, in that case, it is useful to detect type mismatches at compile time.

Parameterized mailboxes use the same parameter mechanism as parameterized classes (see Section 11.23), modules, and interfaces:

```
mailbox #(type = dynamic_type)
```

Where `dynamic_type` represents a special type that enables run-time type-checking (the default).

A parameterized mailbox of a specific type is declared by specifying the type:

```
typedef mailbox #(string) s_mbox;
```

```
s_mbox sm = new;  
string s;
```

```
sm.put( "hello" );  
...  
sm.get( s ); // s <- "hello"
```

Parameterized mailboxes provide all the same standard methods as *dynamic* mailboxes: `num()`, `new()`, `get()`, `peek()`, `put()`, `try_get()`, `try_peek()`, `try_put()`.

The only difference between a generic (dynamic) mailbox and a parameterized mailbox is that for a parameterized mailbox, the compiler ensures that the `put`, `try_put`, `peek`, `try_peek`, `get` and `try_get` methods are compatible with the mailbox type, so that all type mismatches are caught by the compiler and not at run-time.

13.5 Event

In Verilog, named events are static objects that can be triggered via the `->` operator, and processes can wait for an event to be triggered via the `@` operator. SystemVerilog events support the same basic operations, but enhance Verilog events in several ways. The most salient enhancement is that the triggered state of Verilog named events has no duration, whereas in SystemVerilog this state persists throughout the time-step in which the event triggered. Also, SystemVerilog events act as handles to synchronization queues, thus, they can be passed as arguments to tasks, and they can be assigned to one another or compared.

Existing Verilog event operations (`@` and `->`) are backward compatible and continue to work the same way when used in the static Verilog context. The additional functionality described below works with all events in either the static or dynamic context.

A SystemVerilog event provides a handle to an underlying synchronization object. When a process waits for an event to be triggered, the process is put on a queue maintained within the synchronization object. Processes can wait for a SystemVerilog event to be triggered either via the `@` operator, or by using the `wait()` construct to examine their triggered state. Events are triggered using the `->` or the `->>` operator.

```
event_trigger ::= // from Annex A.6.5
    -> hierarchical_event_identifier ;
    | ->> [ delay_or_event_control ] hierarchical_event_identifier ;
```

Syntax 13-1—Event trigger syntax (excerpt from Annex A)

The syntax to declare named events is discussed in Section 3.8.

13.5.1 Triggering an event

Named events are triggered via the `->` operator.

Triggering an event unblocks all processes currently waiting on that event. When triggered, named events behave like a one-shot, that is, the trigger state itself is not observable, only its effect. This is similar to the way in which an edge can trigger a flip-flop but the state of the edge cannot be ascertained, i.e., `if (posedge clock)` is illegal.

13.5.2 Nonblocking event trigger

Nonblocking events are triggered using the `->>` operator.

The effect of the `->>` operator is that the statement executes without blocking and it creates a nonblocking assign update event in the time in which the delay control expires, or the event-control occurs. The effect of this update event shall be to trigger the referenced event in the nonblocking assignment region of the simulation cycle.

13.5.3 Waiting for an event

The basic mechanism to wait for an event to be triggered is via the event control operator, `@`.

```
@ hierarchical_event_identifier;
```

LRM 18

The `@` operator blocks the calling process until the given event is triggered.

For a trigger to unblock a process waiting on an event, the waiting process must execute the `@` statement before the triggering process executes the trigger operator, `->`. If the trigger executes first, then the waiting process remains blocked.

13.5.4 Persistent trigger: triggered property

SystemVerilog can distinguish the event trigger itself, which is instantaneous, from the event's triggered state, which persists throughout the time-step (i.e., until simulation time advances). The triggered event property allows users to examine this state.

The triggered property is invoked using a method-like syntax:

```
hierarchical_event_identifier.triggered
```

LRM 18

The triggered event property evaluates to true if the given event has been triggered in the current time-step and false otherwise. If `event_identifier` is `null`, then the triggered event property evaluates to false.

The triggered event property is most useful when used in the context of a `wait` construct:

```
wait ( hierarchical_event_identifier.triggered )
```

Using this mechanism, an event trigger shall unblock the waiting process whether the `wait` executes before or at the same simulation time as the trigger operation. The triggered event property, thus, helps eliminate a common race condition that occurs when both the trigger and the `wait` happen at the same time. A process that blocks waiting for an event might or might not unblock, depending on the execution order of the waiting and triggering processes. However, a process that waits on the triggered state always unblocks, regardless of the order of execution of the wait and trigger operations.

Example:

```
event done, blast;           // declare two new events
event done_too = done;       // declare done_too as alias to done

task trigger( event ev );
    -> ev;
endtask

...

fork
    @ done_too;                // wait for done through done_too
    #1 trigger( done );        // trigger done through task trigger
join

fork
    -> blast;
    wait ( blast.triggered );
join
```

The first fork in the example shows how two event identifiers, `done` and `done_too`, refer to the same synchronization object, and also how an event can be passed to a generic task that triggers the event. In the example, one process waits for the event via `done_too`, while the actual triggering is done via the `trigger` task that is passed `done` as an argument.

In the second fork, one process can trigger the event `blast` before the other process (if the processes in the `fork...join` execute in source order) has a chance to execute, and wait for the event. Nonetheless, the second process unblocks and the fork terminates. This is because the process waits for the event's triggered state, which remains in its triggered state for the duration of the time-step.

13.6 Event sequencing: wait_order()

The `wait_order` construct suspends the calling process until all of the specified events are triggered in the

given order (left to right) or any of the un-triggered events are triggered out of order and thus causes the operation to fail.

The syntax for the `wait_order` construct is:

```
wait_statement ::= // from Annex A.6.5
    ...
    | wait_order ( hierarchical_identifier [ , hierarchical_identifier ] ) action_block
action_block ::=
    statement_or_null
    | [ statement ] else statement
```

Syntax 13-2—wait_order event sequencing syntax (excerpt from Annex A)

For `wait_order` to succeed, at any point in the sequence, the subsequent events—which must all be un-triggered at this point, or the sequence would have already failed—must be triggered in the prescribed order. Preceding events are not limited to occur only once. That is, once an event occurs in the prescribed order, it can be triggered again without causing the construct to fail.

Only the first event in the list can wait for the persistent `triggered` property.

The action taken when the construct fails depends on whether or not the optional phrase `else` statement (the fail statement) is specified. If it is specified, then the given statement is executed upon failure of the construct. If the fail statement is not specified, a failure generates a run-time error.

For example:

```
wait_order( a, b, c );
```

suspends the current process until events a, b, and c trigger in the order a -> b -> c. If the events trigger out of order, a run-time error is generated.

Example:

```
wait_order( a, b, c ) else $display( "Error: events out of order" );
```

In this example, the fail statement specifies that upon failure of the construct, a user message be displayed, but without an error being generated.

Example:

```
bit success;
wait_order( a, b, c ) success = 1; else success = 0;
```

In this example, the completion status is stored in the variable `success`, without an error being generated.

13.7 Event variables

An event is a unique data type with several important properties. Unlike Verilog, SystemVerilog events can be assigned to one another. When one event is assigned to another the synchronization queue of the source event is shared by both the source and the destination event. In this sense, events act as full fledged variables and not merely as labels.

13.7.1 Merging events

When one event variable is assigned to another, the two become merged. Thus, executing `->` on either event

variable affects processes waiting on either event variable.

For example:

```

event a, b, c;
a = b;
-> c;
-> a;    // also triggers b
-> b;    // also triggers a
a = c;
b = a;
-> a;    // also triggers b and c
-> b;    // also triggers a and c
-> c;    // also triggers a and b

```

When events are merged, the assignment only affects the execution of subsequent event control or wait operations. If a process is blocked waiting for event1 when another event is assigned to event1, the currently waiting process shall never unblock. For example:

```

fork
  T1: while(1) @ E2;
  T2: while(1) @ E1;
  T3: begin
      E2 = E1;
      while(1) -> E2;
  end
join

```

This example forks off three concurrent processes. Each process starts at the same time. Thus, at the same time that process T1 and T2 are blocked, process T3 assigns event E1 to E2. This means that process T1 shall never unblock, because the event E2 is now E1. To unblock both threads T1 and T2, the merger of E2 and E1 must take place before the fork.

13.7.2 Reclaiming events

When an event variable is assigned the special **null** value, the association between the event variable and the underlying synchronization queue is broken. When no event variable is associated with an underlying synchronization queue, the resources of the queue itself become available for re-use.

Triggering a **null** event shall have no effect. The outcome of waiting on a **null** event is undefined, and implementations can issue a run-time warning.

For example:

```

event E1 = null;
@ E1;                // undefined: might block forever or not at all
wait( E1.triggered ); // undefined
-> E1;                // no effect

```

13.7.3 Events comparison

Event variables can be compared against other event variables or the special value **null**. Only the following operators are allowed for comparing event variables:

- Equality (==) with another event or with **null**.
- Inequality (!=) with another event or with **null**.
- Case equality (===) with another event or with **null** (same semantics as ==).

| SystemVerilog 3.1a/draft 5

- Case inequality (`!==(`) with another event or with `null` (same semantics as `!=`).
- Test for a boolean value that shall be 0 if the event is `null` and 1 otherwise.

Example:

```
event E1, E2;
if ( E1 ) // same as if ( E1 != null )
    E1 = E2;
if ( E1 == E2 )
    $display( "E1 and E2 are the same event" );
```

Section 14 Scheduling Semantics

14.1 Execution of a hardware model and its verification environment

The balance of the sections of this standard describes the behavior of each of the elements of the language. This section gives an overview of the interactions between these elements, especially with respect to the scheduling and execution of events. Although SystemVerilog is not limited to simulation, the semantics of the language are defined for event directed simulation, and other uses of the hardware description language are abstracted from this base definition.

14.2 Event simulation

The SystemVerilog language is defined in terms of a discrete event execution model. The discrete event simulation is described in more detail in this section to provide a context to describe the meaning and valid interpretation of SystemVerilog constructs. These resulting definitions provide the standard SystemVerilog reference algorithm for simulation, which all compliant simulators shall implement. Note that there is a great deal of choice in the definitions that follow, and differences in some details of execution are to be expected between different simulators. In addition, SystemVerilog simulators are free to use different algorithms than those described in this section, provided the user-visible effect is consistent with the reference algorithm.

A SystemVerilog description consists of connected threads of execution or processes. Processes are objects that can be evaluated, that can have state, and that can respond to changes on their inputs to produce outputs. Processes are concurrently scheduled elements, such as `initial` blocks. Example of processes include, but are not limited to, primitives, `initial`, `always`, `always_comb`, `always_latch`, and `always_ff` procedural blocks, continuous assignments, asynchronous tasks, and procedural assignment statements.

LRM 55

Every change in state of a net or variable in the system description being simulated is considered an update event.

Processes are sensitive to update events. When an update event is executed, all the processes that are sensitive to that event are considered for evaluation in an arbitrary order. The evaluation of a process is also an event, known as an evaluation event.

Evaluation events also include PLI callbacks, which are points in the execution model where user-defined external routines can be called from the simulation kernel.

In addition to events, another key aspect of a simulator is time. The term simulation time is used to refer to the time value maintained by the simulator to model the actual time it would take for the system description being simulated. The term time is used interchangeably with simulation time in this section.

To fully support clear and predictable interactions, a single time slot is divided into multiple regions where events can be scheduled that provide for an ordering of particular types of execution. This allows properties and checkers to sample data when the design under test is in a stable state. Property expressions can be safely evaluated, and testbenches can react to both properties and checkers with zero delay, all in a predictable manner. This same mechanism also allows for non-zero delays in the design, clock propagation, and/or stimulus and response code to be mixed freely and consistently with cycle accurate descriptions.

14.3 The stratified event scheduler

A compliant SystemVerilog simulator must maintain some form of data structure that allows events to be dynamically scheduled, executed and removed as the simulator advances through time. The data structure is normally implemented as a time ordered set of linked lists, which are divided and sub-divided in a well defined manner.

The first division is by time. Every event has one and only one simulation execution time, which at any given

point during simulation can be the current time or some future time. All scheduled events at a specific time define a time slot. Simulation proceeds by executing and removing all events in the current simulation time slot before moving on to the next non-empty time slot, in time order. This procedure guarantees that the simulator never goes backwards in time.

A time slot is divided into a set of ordered regions:

- 1) Preponed
- 2) Pre-active
- 3) Active
- 4) Inactive
- 5) Pre-NBA
- 6) NBA
- 7) Post-NBA
- 8) Observed
- 9) Post-observed
- 10) Reactive
- 11) Postponed

The purpose of dividing a time slot into these ordered regions is to provide predictable interactions between the design and testbench code.

Except for the Observed and Reactive regions and the Post-observed PLI region, these regions essentially encompass the Verilog 1364-2001 standard reference model for simulation, with exactly the same level of determinism. This means that legacy Verilog code shall continue to run correctly without modification within the new mechanism. The Postponed region is where the monitoring of signals, and other similar events, takes place. No new value changes are allowed to happen in the time slot once the Postponed region is reached.

The Observed and Reactive regions are new in the SystemVerilog 3.1 standard, and events are only scheduled into these new regions from new language constructs.

The Observed region is for the evaluation of the property expressions when they are triggered. A criterion for this determinism is that the property evaluations must only occur once in any clock triggering time slot. During the property evaluation, pass/fail code shall be scheduled in the Reactive region of the current time slot.

LRM 137

The sampling time of sampled data for property expressions is controlled in the clocking block. The new `#1step` sampling delay provides the ability to sample data immediately before entering the current time slot, and is a preferred construct over other equivalent constructs because it allows the `1step` time delay to be parameterized. This `#1step` construct is a conceptual mechanism that provides a method for defining when sampling takes place, and does not require that an event be created in this previous time slot. Conceptually this `#1step` sampling is identical to taking the data samples in the Preponed region of the current time slot.

Code specified in the program block, and pass/fail code from property expressions, are scheduled in the Reactive region.

LRM 137

The Pre-active, Pre-NBA, and Post-NBA are new in the SystemVerilog 3.1 standard but support existing PLI callbacks. The Post-observed region is new in the SystemVerilog 3.1 standard and has been added for PLI support.

The Pre-active region is specifically for a PLI callback control point that allows for user code to read and write values and create events before events in the Active region are evaluated (see Section 14.4).

The Pre-NBA region is specifically for a PLI callback control point that allows for user code to read and write values and create events before the events in the NBA region are evaluated (see Section 14.4).

The Post-NBA region is specifically for a PLI callback control point that allows for user code to read and write values and create events after the events in the NBA region are evaluated (see Section 14.4).

The Post-observed region is specifically for a PLI callback control point that allows for user code to read values after properties are evaluated (in Observed or earlier region).

The flow of execution of the event regions is specified in Figure 14-1.

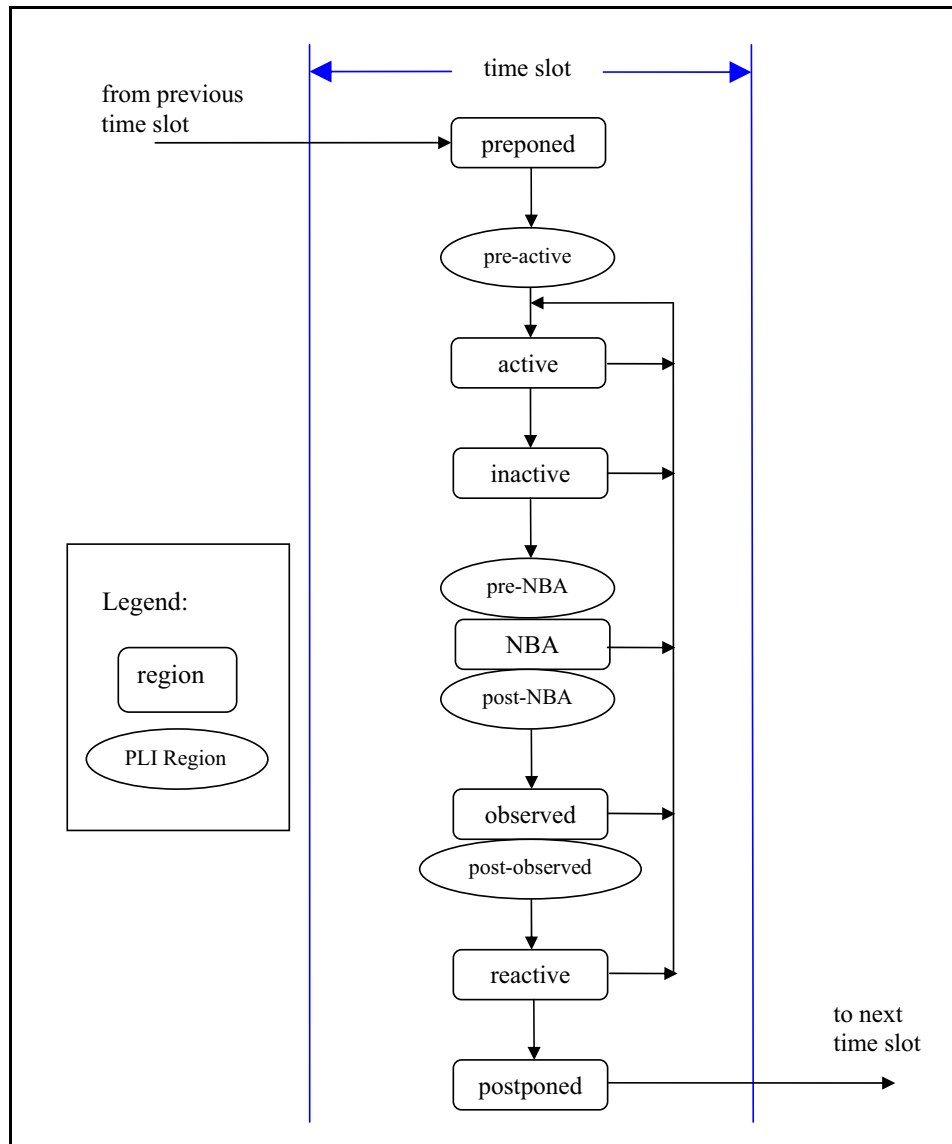

Figure 14-1 — The SystemVerilog flow of time slots and event regions

The Active, Inactive, Pre-NBA, NBA, Post-NBA, Observed, Post-observed and Reactive regions are known as the *iterative* regions.

The Preponed region is specifically for a PLI callback control point that allows for user code to access data at the current time slot before any net or variable has changed state.

The Active region holds current events being evaluated and can be processed in any order.

The Inactive region holds the events to be evaluated after all the active events are processed.

An *explicit* #0 delay requires that the process be suspended and an event scheduled into the Inactive region of the current time slot so that the process can be resumed in the next inactive to active iteration.

LRM 137

A nonblocking assignment creates an event in the NBA region, scheduled for current or a later simulation time.

The Postponed region is specifically for a PLI callback control point that allows for user code to be suspended until after all the Active, Inactive and NBA regions have completed. Within this region, it is illegal to write values to any net or variable, or to schedule an event in any previous region within the current time slot.

14.3.1 The SystemVerilog simulation reference algorithm

```

execute_simulation {
    T = 0;
    initialize the values of all nets and variables;
    schedule all initialization events into time 0 slot;
    while (some time slot is non-empty) {
        move to the next future non-empty time slot and set T;
        execute_time_slot (T);
    }
}

execute_time_slot {
    execute_region (preponed);
    while (some iterative region is non-empty) {
        execute_region (active);
        scan iterative regions in order {
            if (region is non-empty) {
                move events in region to the active region;
                break from scan loop;
            }
        }
    }
    execute_region (postponed);
}

execute_region {
    while (region is non-empty) {
        E = any event from region;
        remove E from the region;
        if (E is an update event) {
            update the modified object;
            evaluate processes sensitive to the object and possibly schedule
            further events for execution;
        } else { /* E is an evaluation event */
            evaluate the process associated with the event and possibly
            schedule further events for execution;
        }
    }
}

```

The Iterative regions and their order are: Active, Inactive, Pre-NBA, NBA, Post-NBA, Observed, Post-observed and Reactive.

14.4 The PLI callback control points

There are two kinds of PLI callbacks, those that are executed immediately when some specific activity occurs, and those that are explicitly registered as a one-shot evaluation event.

It is possible to explicitly schedule a PLI callback event in any region. Thus, an explicit PLI callback registration is identified by a tuple: (time, region).

The following list provides the mapping from the various current PLI callbacks

Table 14-3: PLI Callbacks

Callback	Identification
tf_synchronize	(time, Pre-NBA)
tf_ishynchronize	(time, Pre-NBA)
tf_rosynchronize	(time, Postponed)
tf_irosynchronize	(time, Postponed)
cbReadWriteSynch	(time, Post-NBA)
cbAtStartOfSimTime	(time, Pre-active)
cbReadOnlySynch	(time, Postponed)
cbNBASynch	(time, Pre-NBA)
cbAtEndOfSimTime	(time, Postponed)
cbNextSimTime	(time, Pre-active)
cbAfterDelay	(time, Pre-active)

Section 15

Clocking Blocks

LRM 137

15.1 Introduction (informative)

In Verilog, the communication between blocks is specified using module ports. SystemVerilog adds the interface, a key construct that encapsulates the communication between blocks, thereby enabling users to easily change the level of abstraction at which the inter-module communication is to be modeled.

An interface can specify the signals or nets through which a testbench communicates with a device under test. However, an interface does not explicitly specify any timing disciplines, synchronization requirements, or clocking paradigms.

SystemVerilog adds the `clocking` block that identifies clock signals, and captures the timing and synchronization requirements of the blocks being modeled. A clocking block assembles signals that are synchronous to a particular clock, and makes their timing explicit. The clocking block is a key element in a cycle-based methodology, which enables users to write testbenches at a higher level of abstraction. Rather than focusing on signals and transitions in time, the test can be defined in terms of cycles and transactions. Depending on the environment, a testbench can contain one or more clocking blocks, each containing its own clock plus an arbitrary number of signals.

LRM 137

The clocking block separates the timing and synchronization details from the structural, functional, and procedural elements of a testbench. Thus, the timing for sampling and driving clocking block signals is implicit and relative to the clocking-block's clock. This enables a set of key operations to be written very succinctly, without explicitly using clocks or specifying timing. These operations are:

- Synchronous events
- Input sampling
- Synchronous drives

15.2 Clocking block declaration

LRM 137

The syntax for the `clocking` block is:

```

clocking_declaration ::=                                     //from Annex A.6.11
    [ default ] clocking [ clocking_identifier ] clocking_event ;
    { clocking_item }
    endclocking [ : clocking_identifier ]

clocking_event ::=
    @ identifier
    | @ ( event_expression )

clocking_item ::=
    default default_skew ;
    | clocking_direction list_of_clocking_decl_assign ;
    | { attribute_instance } concurrent_assertion_item_declaration

default_skew ::=
    input clocking_skew
    | output clocking_skew
    | input clocking_skew output clocking_skew

clocking_direction ::=
    input [ clocking_skew ]
    | output [ clocking_skew ]
    | input [ clocking_skew ] output [ clocking_skew ]
    | inout

list_of_clocking_decl_assign ::= clocking_decl_assign { , clocking_decl_assign }
clocking_decl_assign ::= signal_identifier [ = hierarchical_identifier ]
clocking_skew ::=
    edge_identifier [ delay_control ]
    | delay_control

edge_identifier ::= posedge | negedge                                     //from Annex A.7.4
delay_control ::=                                             //from Annex A.6.5
    # delay_value
    | # ( mintypmax_expression )

```

Syntax 15-1—*Class Clocking block syntax (excerpt from Annex A)*

The *delay_control* must be either a time literal or a constant expression that evaluates to a positive integer value.

The *clocking_identifier* specifies the name of the clocking block being declared.

The *signal_identifier* identifies a signal in the scope enclosing the clocking block declaration, and declares the name of a signal in the clocking block. Unless a *hierarchical_expression* is used, both the signal and the *clocking_item* names shall be the same.

The *clocking_event* designates a particular event to act as the clock for the clocking block. Typically, this expression is either the **posedge** or **negedge** of a clocking signal. The timing of all the other signals specified in a given clocking block is governed by the clocking event. All **input** or **inout** signals specified in the clocking block are sampled when the corresponding clock event occurs. Likewise, all **output** or **inout** signals in the clocking block are driven when the corresponding clock event occurs. Bidirectional signals (**inout**) are sampled as well as driven.

The *clocking_skew* determines how many time units away from the clock event a signal is to be sampled or driven. Input skews are implicitly negative, that is, they always refer to a time before the clock, whereas output skews always refer to a time after the clock (see Section 15.3). When the clocking event specifies a simple edge, instead of a number, the skew can be specified as the specific edge of the signal. A single skew can be

specified for the entire block by using a **default** clocking item.

```

clocking ck1 @(posedge clk);
    default input #1step output negedge; // legal
    // outputs driven on the negedge clk
    input ... ;
    output ... ;
endclocking

clocking ck2 @(clk); // no edge specified!
    default input #1step output negedge; // legal
    input ... ;
    output ... ;
endclocking

```

LRM 137

LRM 219

The *hierarchical_identifier* specifies that, instead of a local port, the signal to be associated with the clocking block is specified by its hierarchical name (cross-module reference).

LRM 137

Example:

```

clocking bus @(posedge clock1);
    default input #10ns output #2ns;
    input data, ready, enable = top.mem1.enable;
    output negedge ack;
    input #1step addr;
endclocking

```

In the above example, the first line declares a clocking block called `bus` that is to be clocked on the positive edge of the signal `clock1`. The second line specifies that by default all signals in the clocking block shall use a `10ns` input skew and a `2ns` output skew. The next line adds three input signals to the clocking block: `data`, `ready`, and `enable`; the last signal refers to the hierarchical signal `top.mem1.enable`. The fourth line adds the signal `ack` to the clocking block, and overrides the default output skew so that `ack` is driven on the negative edge of the clock. The last line adds the signal `addr` and overrides the default input skew so that `addr` is sampled one step before the positive edge of the clock.

LRM 137

Unless otherwise specified, the default **input** skew is **1step** and the default **output** skew is **0**. A **step** is a special time unit whose value is defined in Section 18.10. A **1step** input skew allows input signals to sample their steady-state values in the time step immediately before the clock event (i.e., in the preceding Postponed region). Unlike other time units, which represent physical units, a step cannot be used to set or modify either the precision or the timeunit.

15.3 Input and output skews

Input (or inout) signals are sampled at the designated clock event. If an input skew is specified then the signal is sampled at *skew* time units *before* the clock event. Similarly, output (or inout) signals are driven *skew* simulation time units *after* the corresponding clock event. Figure 15-1 shows the basic sample/drive timing for a positive edge clock.

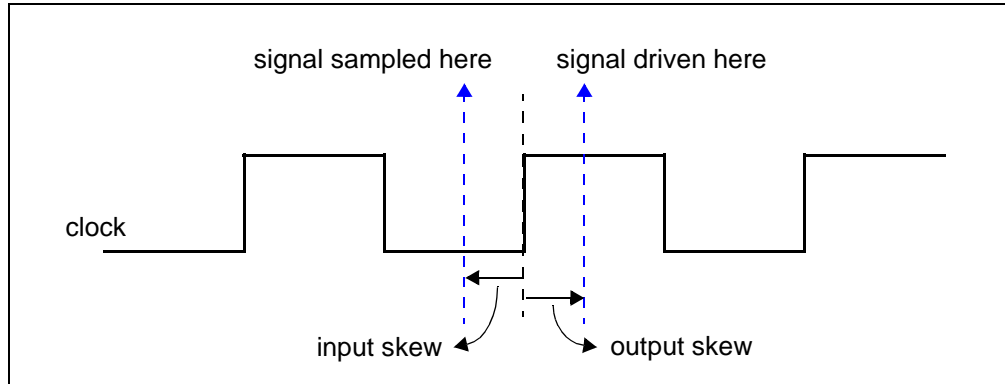

Figure 15-1 — Sample and drive times including skew with respect to the positive edge of the clock.

A skew must be a constant expression, and can be specified as a parameter. If the skew does not specify a time unit, the current time unit is used. If a number is used, the skew is interpreted using the timescale of the current scope.

```
clocking dram @(clk);
    input #1ps address;
    input #5 output #6 data;
endclocking
```

An input skew of `1step` indicates that the signal is to be sampled at the end of the previous time step. That is, the value sampled is always the signal's last value immediately before the corresponding clock edge.

Inputs with explicit `#0` skew are sampled at the same time as their corresponding clocking event, but to avoid races, they are sampled in the Observed region. Likewise, clocking block outputs with no skew (or explicit `#0` skew) are driven at the same time as their specified clocking event, as nonblocking assignments (in the NBA region).

LRM 137

Skews are declarative constructs, thus, they are semantically very different from the syntactically similar procedural delay statement. In particular, an explicit `#0` skew, does not suspend any process nor does it execute or sample values in the Inactive region.

15.4 Hierarchical expressions

Any signal in a clocking block can be associated with an arbitrary hierarchical expression. As described in Section 15.2, a hierarchical expression is introduced by appending an equal sign (=) followed by the hierarchical expression:

```
clocking cd1 @(posedge phi1);
    input #1step state = top.cpu.state;
endclocking
```

However, hierarchical expressions are not limited to simple names or signals in other scopes. They can be used to declare slices and concatenations (or combinations thereof) of signals in other scopes or in the current scope.

```
clocking mem @(clock);
    input instruction = { opcode, regA, regB[3:1] };
endclocking
```

15.5 Signals in multiple clocking blocks

LRM 137

The same signals—clock, inputs, inouts, or outputs—can appear in more than one clocking block. Clocking blocks that use the same clock (or clocking expression) shall share the same synchronization event, in the same manner as several latches can be controlled by the same clock. Input semantics are described in Section 15.12, and output semantics are described in Section 15.14.

15.6 Clocking block scope and lifetime

LRM 137

A **clocking** block is both a declaration and an instance of that declaration. A separate instantiation step is not necessary. Instead, one copy is created for each instance of the block containing the declaration (like an always block). Once declared, the clocking signals are available via the clocking block name and the dot (.) operator:

```
dom.sig // signal sig in clocking dom
```

Clocking blocks cannot be nested. They cannot be declared inside functions, tasks, packages, or outside all declarations in a compilation unit. Clocking blocks can only be declared inside a module, interface or program (see Section 16).

LRM 58

Clocking blocks have static lifetime and scope local to their enclosing module, interface or program.

15.7 Multiple clocking blocks example

LRM 137

In this example, a simple test program includes two clocking blocks. The program construct used in this example is discussed in Section 16.

```
program test( input phi1, input [15:0] data, output logic write,
             input phi2, inout [8:1] cmd, input enable
             );
  reg [8:1] cmd_reg;

  clocking cd1 @(posedge phi1);
    input data;
    output write;
    input state = top.cpu.state;
  endclocking

  clocking cd2 @(posedge phi2);
    input #2 output #4ps cmd;
    input enable;
  endclocking

  initial begin
    // program begins here
    ...
    // user can access cd1.data , cd2.cmd , etc...
  end
  assign cmd = enable ? cmd_reg : 'x;
endprogram
```

The test program can be instantiated and connected to a device under test (cpu and mem).

```
module top;
  logic phi1, phi2;
  wire [8:1] cmd; // cannot be logic (two bidirectional drivers)
  logic [15:0] data;
```

```

    test main( phi1, data, write, phi2, cmd, enable );
    cpu cpu1( phi1, data, write );
    mem mem1( phi2, cmd, enable );
endmodule

```

15.8 Interfaces and clocking blocks

LRM 137

A **clocking** encapsulates a set of signals that share a common clock, therefore, specifying a clocking block using a SystemVerilog **interface** can significantly reduce the amount of code needed to connect the testbench. Furthermore, since the signal directions in the clocking block within the testbench are with respect to the testbench, and not the design under test, a **modport** declaration can appropriately describe either direction. A testbench program can be contained within a *program* and its ports can be interfaces that correspond to the signals declared in each clocking block. The interface's wires shall have the same direction as specified in the clocking block when viewed from the testbench side (i.e., **modport test**), and reversed when viewed from the device under test (i.e., **modport dut**).

For example, the previous example could be re-written using interfaces as follows:

```

interface bus_A (input clk);
    logic [15:0] data;
    logic write;
    modport test (input data, output write);
    modport dut (output data, input write);
endinterface

interface bus_B (input clk);
    logic [8:1] cmd;
    logic enable;
    modport test (input enable);
    modport dut (output enable);
endinterface

program test( bus_A.test a, bus_B.test b );

    clocking cd1 @(posedge a.clk);
        input a.data;
        output a.write;
        inout state = top.cpu.state;
    endclocking

    clocking cd2 @(posedge b.clk);
        input #2 output #4ps b.cmd;
        input b.enable;
    endclocking

    initial begin
        // program begins here
        ...
        // user can access cd1.a.data , cd2.b.cmd , etc..
    end
endprogram

```

The test module can be instantiated and connected as before:

```

module top;
    logic phi1, phi2;

```

```

    bus_A a(phi1);
    bus_B b(phi2);

    test main( a, b );
    cpu cpu1( a );
    mem mem1( b );
endmodule

```

Alternatively, in the program test above, the clocking block can be written using both interfaces and hierarchical expressions as:

LRM 137

```

clocking cd1 @(posedge a.clk);
    input data = a.data;
    output write = a.write;
    inout state = top.cpu.state;
endclocking

clocking cd2 @(posedge b.clk);
    input #2 output #4ps cmd = b.cmd;
    input enable = b.enable;
endclocking

```

This would allow using the shorter names (`cd1.data`, `cd2.cmd`, ...) instead of the longer interface syntax (`cd1.a.data`, `cd2.b.cmd`,...).

15.9 Clocking block events

LRM 137

The clocking event of a clocking block is available directly by using the clocking block name, regardless of the actual clocking event used to declare the clocking block.

For example.

```

clocking dram @(posedge phi1);
    inout data;
    output negedge #1 address;
endclocking

```

The clocking event of the `dram` clocking block can be used to wait for that particular event:

```
@( dram );
```

The above statement is equivalent to `@(posedge phi1)`.

15.10 Cycle delay:

The `##` operator can be used to delay execution by a specified number of clocking events, or clock cycles.

The syntax for the cycle delay statement is:

```

procedural_timing_control_statement ::=                                // from Annex A.6.5
    procedural_timing_control_statement_or_null
procedural_timing_control ::=
    ...
    | cycle_delay
cycle_delay ::= ##expression                                       // from Annex A.6.11
               ## integral_number
               | ## identifier
               | ## ( expression )
    
```

LRM-262
LRM 271

LRM 139

Syntax 15-2—Cycle delay syntax (excerpt from Annex A)

The *expression* can be any SystemVerilog expression that evaluates to a positive integer value.

LRM 139

What constitutes a cycle is determined by the default clocking in effect (see Section 15.11). If no default clocking has been specified for the current module, interface, or program then the compiler shall issue an error.

Example:

```

## 5;                // wait 5 cycles (clocking events) using the default clocking
## ( j + 1 );       // wait j+1 cycles (clocking events) using the default clocking
    
```

LRM 271

15.11 Default clocking

One **clocking** can be specified as the default for all cycle delay operations within a given **module**, **interface**, or **program**.

The syntax for the default cycle specification statement is:

```

module_or_generate_item_declaration ::=                               //from Annex A.1.5
    ...
    | default clocking clocking_identifier ;
clocking_declaration ::=                                           //from Annex A.6.11
    [ default ] clocking [ clocking_identifier ] clocking_event ;
    { clocking_item }
    endclocking [ : clocking_identifier ]
    
```

LRM 270

Syntax 15-3—Default clocking syntax (excerpt from Annex A)

The *clocking_identifier* must be the name of a clocking block.

LRM 137

Only one default clocking can be specified in a program, module, or interface. Specifying a default clocking more than once in the same program or module shall result in a compiler error.

A default clocking is valid only within the scope containing the default clocking specification. This scope includes the module, interface, or program that contains the declaration as well as any nested modules or interfaces. It does not include instantiated modules or interfaces.

Example 1. Declaring a clocking as the default:

```

program test( input bit clk, input reg [15:0] data );
  default clocking bus @(posedge clk);
  inout data;
  endclocking

  initial begin
    ## 5;
    if ( bus.data == 10 )
      ## 1;
    else
      ...
  end
endprogram

```

LRM 100

Example 2. Assigning an existing clocking to be the default:

```

module processor ...
  clocking busA @(posedge clk1); ... endclocking
  clocking busB @(negedge clk2); ... endclocking
module cpu( interface y );
  default clocking busA ;
  initial begin
    ## 5; // use busA => (posedge clk1)
    ...
  end
endmodule
endmodule

```

LRM 100

15.12 Input sampling

All clocking block inputs (input or inout) are sampled at the corresponding clocking event. If the input skew is not an explicit #0, then the value sampled corresponds to the signal value at the Postponed region of the time step skew time-units prior to the clocking event (see Figure 15-1 in Section 15.3). If the input skew is an explicit #0, then the value sampled corresponds to the signal value in the Observed region.

LRM 137

Samples happen immediately (the calling process does not block). When a signal appears in an expression, it is replaced by the signal's sampled value, that is, the value that was sampled at the last sampling point.

When the same signal is an input to multiple clocking blocks, the semantics are straightforward; each clocking block samples the corresponding signal with its own clocking event.

LRM 137

15.13 Synchronous events

Explicit synchronization is done via the event control operator, @, which allows a process to wait for a particular signal value change, or a clocking event (see Section 15.9).

The syntax for the synchronization operator is given in Section 8.10.

The expression used with the event control can denote clocking block input (**input** or **inout**), or a slice thereof. Slices can include dynamic indices, which are evaluated once, when the @ expression executes.

LRM 137

These are some example synchronization statements:

— Wait for the next change of signal `ack_1` of clocking block `ram_bus`

```
@(ram_bus.ack_1);
```

- Wait for the next clocking event in clocking block `ram_bus`

```
@(ram_bus);
```

- Wait for the positive edge of the signal `ram_bus.enable`

```
@(posedge ram_bus.enable);
```

- Wait for the falling edge of the specified 1-bit slice `dom.sign[a]`. Note that the index `a` is evaluated at runtime.

```
@(negedge dom.sign[a]);
```

- Wait for either the next positive edge of `dom.sig1` or the next change of `dom.sig2`, whichever happens first.

```
@(posedge dom.sig1 or dom.sig2);
```

- Wait for either the negative edge of `dom.sig1` or the positive edge of `dom.sig2`, whichever happens first.

```
@(negedge dom.sig1 or posedge dom.sig2);
```

The values used by the synchronization event control are the synchronous values, that is, the values sampled at the corresponding clocking event.

15.14 Synchronous drives

- Clocking block outputs (`output` or `inout`) are used to drive values onto their corresponding signals, but at a specified time. That is, the corresponding signal changes value at the indicated clocking event as modified by the output skew. LRM 137

The syntax to specify a synchronous drive is similar to an assignment:

```
statement ::= [ block_identifier : ] { attribute_instance } statement_item           //from Annex A.6.4
statement_item ::=
    ...
    | clocking_drive ;
clocking_drive ::=                                                                    //from Annex A.6.11
    clockvar_expression <= [ cycle_delay ] expression
    | cycle_delay clockvar_expression <= expression
cycle_delay ::= ## expression
clockvar ::= clocking_identifier . identifier
clockvar_expression ::=
    clockvar range
    | clockvar [ range_expression ]
```

LRM 250

LRM 66

Syntax 15-4—Default clocking syntax (excerpt from Annex A)

- The `clockvar_expression` is either a bit-select, slice, or the entire clocking block output whose corresponding LRM 137

signal is to be driven (concatenation is not allowed):

```
dom.sig          // entire clockvar
dom.sig[2]       // bit-select
dom.sig[8:2]     // slice
```

The expression (in the [clocking_drive production](#)) can be any valid expression that is assignment compatible with the type of the corresponding signal. LRM 262

The *event_count* refers to the expression after the ## in the [cycle_delay production](#) and is an integral expression that optionally specifies the number of clocking events (i.e. cycles) that must pass before the statement executes. Specifying a non-zero *event_count* blocks the current process until the specified number of clocking events have elapsed, otherwise the statement executes at the current time. The *event_count* uses syntax similar to the cycle-delay operator (see Section 15.10), however, the synchronous drive uses the clocking block of the signal being driven and not the default clocking. LRM 137

The second form of the synchronous drive uses the intra-assignment syntax. An intra-assignment *event_count* specification also delays execution of the assignment. In this case the process does not block and the right-hand side expression is evaluated when the statement executes.

Examples:

```
bus.data[3:0] <= 4'h5; // drive data in the NBA region of the current cycle
##1 bus.data <= 8'hz; // wait 1 (bus) cycle and then drive data
##2; bus.data <= 2; // wait 2 default clocking cycles, then drive data
bus.data <= ##2 r; // remember the value of r and then drive
// data 2 (bus) cycles later
```

LRM 137

Regardless of when the drive statement executes (due to *event_count* delays), the driven value is assigned to the corresponding signal only at the time specified by the output skew.

15.14.1 Drives and nonblocking assignments

Synchronous signal drives are processed as nonblocking assignments.

A key feature of *inout* clocking block variables and synchronous drives is that a drive does not change the clocking block input. This is because reading the input always yields the last sampled value, and not the driven value. LRM 137

15.14.2 Drive value resolution

When more than one synchronous drive is applied to the same clocking block output (or *inout*) at the same simulation time, the driven values are checked for conflicts. When conflicting drives are detected a runtime error is issued, and each conflicting bit is driven to X (or 0 for a 2-state port). LRM 137

For example:

```
clocking pe @(posedge clk);
    output nibble; // four bit output
endclocking

pe.nibble <= 4'b0101;
pe.nibble <= 4'b0011;
```

The driven value of `nibble` is `4'b0xx1`, regardless of whether `nibble` is a **reg** or a **wire**.

When the same variable is an output from multiple clocking blocks, the last drive determines the value of the variable. This allows a single module to model multi-rate devices, such as a DDR memory, using a different clocking block to model each active edge. For example:

LRM 137

```
reg j;

clocking pe @(posedge clk);
    output j;
endclocking

clocking ne @(negedge clk);
    output j;
endclocking
```

The variable `j` is an output to two clocking blocks using different clocking events (**posedge** vs. **negedge**). When driven, the variable `j` shall take on the value most recently assigned by either clocking block.

LRM 137

Clocking block outputs driving a net (i.e. through different ports) cause the net to be driven to its resolved signal value. When a clocking block output corresponds to a wire, a driver for that wire is created that is updated as if by a continuous assignment from a register inside the clocking block that is updated as a nonblocking assignment.

Section 16

Program Block

16.1 Introduction (informative)

The module is the basic building block in Verilog. Modules can contain hierarchies of other modules, wires, task and function declarations, and procedural statements within always and initial blocks. This construct works extremely well for the description of hardware. However, for the testbench, the emphasis is not in the hardware-level details such as wires, structural hierarchy, and interconnects, but in modeling the complete environment in which a design is verified. A lot of effort is spent getting the environment properly initialized and synchronized, avoiding races between the design and the testbench, automating the generation of input stimuli, and reusing existing models and other infrastructure.

The program block serves three basic purposes:

- 1) It provides an entry point to the execution of testbenches.
- 2) It creates a scope that encapsulates program-wide data.
- 3) It provides a syntactic context that specifies scheduling in the Reactive region.

LRM 137

The program construct serves as a clear separator between design and testbench, and, more importantly, it specifies specialized execution semantics in the Reactive region for all elements declared within the program.

Together with clocking blocks, the program construct provides for race-free interaction between the design and the testbench, and enables cycle and transaction level abstractions.

LRM 137

The abstraction and modeling constructs of SystemVerilog simplify the creation and maintenance of testbenches. The ability to instantiate and individually connect each program instance enables their use as generalized models.

16.2 The program construct

A typical program contains type and data declarations, subroutines, connections to the design, and one or more procedural code streams. The connection between design and testbench uses the same interconnect mechanism as used by SystemVerilog to specify port connections, including interfaces. The syntax for the program block is:

```

program_nonansi_header ::=                                     // from Annex A.1.3
    { attribute_instance } program [ lifetime ] program_identifier
    [ parameter_port_list ] list_of_ports ;
program_ansi_header ::=
    { attribute_instance } program [ lifetime ] program_identifier
    [ parameter_port_list ] [ list_of_port_declarations ] ;
program_declaration ::=
    program_nonansi_header [ timeunits_declaration ] { program_item }
    endprogram [ : program_identifier ]
    | program_ansi_header [ timeunits_declaration ] { non_port_program_item }
    endprogram [ : program_identifier ]
    | { attribute_instance } program program_identifier (.*);
    [ timeunits_declaration ] { program_item }
    endprogram [ : program_identifier ]
    | extern program_nonansi_header
    | extern program_ansi_header

program_item ::=                                           // from Annex A.1.7
    port_declaration ;
    | non_port_program_item
non_port_program_item ::=
    { attribute_instance } continuous_assign
    | { attribute_instance } module_or_generate_item_declaration
    | { attribute_instance } specparam_declaration
    | { attribute_instance } local_parameter_declaration
    | { attribute_instance } parameter_declaration
    | { attribute_instance } initial_construct
    | { attribute_instance } concurrent_assertion_item
    | { attribute_instance } timeunits_declaration19
    | class_declaration

lifetime ::= static | automatic                             // from Annex A.2.1.3

```

LRM 242
LRM 250

LRM 99

Syntax 16-1—Program declaration syntax (excerpt from Annex A)

For example:

```

program test (input clk, input [16:1] addr, inout [7:0] data);
    initial ...
endprogram

```

or

```

program test ( interface device_ifc );
    initial ...
endprogram

```

A more complete example is included in Sections 15.7 and 15.8.

Although the **program** construct is new to SystemVerilog, its inclusion is a natural extension. The **program** construct can be considered a leaf module with special execution semantics. Once declared, a program block can be instantiated in the required hierarchical location (typically at the top level) and its ports can be connected in the same manner as any other module.

Program blocks can be nested within modules or interfaces. This allows multiple cooperating programs to share variables local to the scope. Nested programs with no ports or top-level programs that are not explicitly instantiated are implicitly instantiated once. Implicitly instantiated programs have the same instance and declaration name. For example:

```

module test(...)
    int shared; // variable shared by programs p1 and p1

    program p1;
        ...
    endprogram

    program p2;
        ...
    endprogram // p1 and p2 are implicitly instantiated once in module test

endmodule

```

A program block can contain one or more **initial** blocks. It cannot contain **always** blocks, UDPs, modules, interfaces, or other programs.

Type and data declarations within the program are local to the program scope and have static lifetime. Program variables can only be assigned using blocking assignments. Non-program variables can only be assigned using nonblocking assignments. Using nonblocking assignments with program variables or blocking assignments with design (non-program) variables shall be an error. References to program variables from outside any program block shall be an error.

LRM 68

16.3 Multiple programs

It is allowed to have any arbitrary number of program definitions or instances. The programs can be fully independent (without inter-program communication), or cooperative. The degree of communication can be controlled by choosing to share data using nested blocks, packages, or hierarchical references, or making the data private by declaring it inside the corresponding program block.

LRM 58

16.4 Eliminating testbench races

There are two major sources of non-determinism in Verilog. The first one is that active events are processed in an arbitrary order. The second one is that statements without time-control constructs in behavioral blocks do not execute as one event. However, from the testbench perspective, these effects are all unimportant details. The primary task of a testbench is to generate valid input stimulus for the design under test, and to verify that the device operates correctly. Furthermore, testbenches that use cycle abstractions are only concerned with the stable or steady state of the system for both checking the current outputs and for computing stimuli for the next cycle. Formal tools also work in this fashion.

Statements within a program block that are sensitive to changes (e.g., update events) in design signals (declared in modules, not program blocks) are scheduled in the Reactive region. Consider a program block that contains the statement `@(clk) S1;` where `clk` is a design signal in some module. Every transition of signal `clk` will cause the statement `S1` to be scheduled into the Reactive region. Likewise, initial blocks within program blocks are scheduled in the Reactive region; in contrast, initial blocks in modules are scheduled in the Active region. In addition, design signals driven from within the program must be assigned using nonblocking assignments and are updated in the NBA region. Thus, even signals driven with no delay are propagated into the design as one event. With this behavior, correct cycle semantics can be modeled without races; thereby making program-based testbenches compatible with clocked assertions and formal tools.

LRM 137

Since the program schedules events in the Reactive region, the clocking block construct is very useful to automatically sample the steady-state values of previous time steps or clock cycles. Programs that read design values exclusively through clocking blocks with `#0` input skews are insensitive to read-write races. It is important

LRM 137

to note that simply sampling input signals (or setting non-zero skews on clocking block inputs) does not eliminate the potential for races. Proper input sampling only addresses a single clocking block. With multiple clocks, the arbitrary order in which overlapping or simultaneous clocks are processed is still a potential source for races. The program construct addresses this issue by scheduling its execution in the Reactive region, after all design events have been processed, including clocks driven by nonblocking assignments.

16.4.1 Zero-skew clocking block races

LRM 137

When a clocking block sets both input and output skews to #0 (see Section 15.3) then its inputs are sampled (in the observed region) at the same time as its outputs are driven (in the NBA region). This type of explicit #0 delay processing is a common source of non-determinism that can result in races. Nonetheless, even in this case, the program minimizes races by means of two mechanisms. First, by constraining program statements to be scheduled in the Reactive region, after all explicit #0 delay transitions have propagated through the design and the system has reached a quasi steady state. Second, by requiring design variables or nets to be modified only via nonblocking assignments. These two mechanisms reduce the likelihood of a race; nonetheless, a race is still possible when skews are set to explicit #0.

16.5 Blocking tasks in cycle/event mode

Calling program tasks or functions from within design modules is illegal and shall result in an error. This is because the design must not be aware of the testbench. Programs are allowed to call tasks or functions in other programs or within design modules. Functions within design modules can be called from a program, and require no special handling. However, blocking tasks (a task that does not execute in 0 simulation time) within design modules that are called from a program do require explicit synchronization upon return from the task. That is, when blocking tasks return to the program code, the program block execution is automatically postponed until the Reactive region. The copy out of the parameters happens when the task returns.

LRM 137

Calling blocking tasks in design modules from within programs requires careful consideration. Expressions evaluated by the task before blocking on the first timing control shall use the values after they have been updated by nonblocking assignments. In contrast, if the task is called from a module at the start of the time step (before nonblocking assignments are processed) then those same expressions shall use the values before they have been updated by nonblocking assignments.

```
module ...
  task T;
    S1: a = b;      // might execute before or after the Observe region
    #5;
    S2: b <= 1'b1; // always executes before the Observe region
  endtask
endmodule
```

If task `T`, above, is called from within a module, then the statement `S1` can execute immediately when the Active region is processed, before variable `b` is updated by a nonblocking assignment. If the same task is called from within a program, then the statement `S1` shall execute when the Reactive region is processed, after variable `b` might have been updated by nonblocking assignments. Statement `S2` always executes immediately after the delay expires; it does not wait for the Reactive region even though it was originally called from the program block.

16.6 Program control tasks

In addition to the normal simulation control tasks (`$stop` and `$finish`), a program can use the `$exit` control task.

16.6.1 `$exit()`

Each program can be finished by calling the `$exit` system task. When all programs exit, the simulation finishes.

The syntax for the `$exit` system task is:

```
task $exit();
```

When all `initial` blocks in a program finish (i.e., they execute their last statement), the program implicitly calls `$exit`. Calling `$exit` causes all processes spawned by the current program to be terminated.

Section 17 Assertions

17.1 Introduction (informative)

SystemVerilog adds features to specify assertions of a system. An assertion specifies a behavior of the system. Assertions are primarily used to validate the behavior of a design. In addition, assertions can be used to provide functional coverage and generate input stimulus for validation.

There are two kinds of assertions: concurrent and immediate.

- Immediate assertions follow simulation event semantics for their execution and are executed like a statement in a procedural block. Immediate assertions are primarily intended to be used with simulation.
- Concurrent assertions are based on clock semantics and use sampled values of variables. One of the goals of SystemVerilog assertions is to provide a common semantic meaning for assertions so that they can be used to drive various design and verification tools. Many tools, such as formal verification tools, evaluate circuit descriptions using a cycle-based semantics, which typically relies on a clock signal or signals to drive the evaluation of the circuit. Any timing or event behavior between clock edges is abstracted away. Concurrent assertions incorporate this these clock semantic. While this approach generally simplifies the evaluation of a circuit description, there are a number of scenarios under which this cycle-based evaluation provides different behavior from the standard event-based evaluation of SystemVerilog.

LRM 238

This section describes both types of assertions.

17.2 Immediate assertions

The immediate assertion statement is a test of an expression performed when the statement is executed in the procedural code. The expression is non-temporal and ~~treated as a condition as in an~~ is interpreted the same way as an expression in the condition of a procedural `if` statement. That is, if the expression evaluates to X, Z or 0, then it is interpreted as being false and the assertion is said to fail. Otherwise, the expression is interpreted as being true and the assertion is said to pass.

LRM 238

The immediate `assert` statement is a *statement_item* and can be specified anywhere a procedural statement is specified.

LRM 240

```

procedural_assertion_item procedural_assertion_statement ::= //from Annex A.6.10
    ...
    | immediate_assert_statement
immediate_assert_statement ::=
    assert ( expression ) action_block
action_block ::= //from Annex A.6.3
    statement_or_null
    | [ statement ] else statement
    
```

Syntax 17-1—Immediate assertion syntax (excerpt from Annex A)

The *action_block* specifies what actions are taken upon success or failure of the assertion. The statement associated with the success of the `assert` statement is the first statement. It is called the *pass statement* and is executed if the expression evaluates to true. ~~The evaluation of the expression follows the same semantic as that of the conditional context of the if statement. As with the if statement, if the conditional expression evaluates to x, z or 0, then the assertion fails.~~ The pass statement can, for example, record the number of successes for a coverage log, but can be omitted altogether. If the pass statement is omitted, then no user-specified action is

LRM 238

taken when the assert expression is true. The statement associated with **else** is called a *fail statement* and is executed if the ~~assertion fails. That is, the expression does not evaluate to a known, non-zero value~~ expression evaluates to false. The **else** statement can also be omitted. The action block is executed immediately after the evaluation of the assert expression.

The optional statement label (identifier and colon) creates a named block around the assertion statement (or any other SystemVerilog statement) and can be displayed using the `%m` format specification.

```
assert_foo : assert (foo) $display("%m passed"); else $display("%m failed");
```

Note: The assertion control system tasks are described in Section 23.9.

Since the assertion is a statement that something must be true, the failure of an assertion shall have a severity associated with it. By default, the severity of an assertion failure is *error*. Other severity levels can be specified by including one of the following severity system tasks in the fail statement:

- `$fatal` is a run-time fatal, which shall terminate the simulation with an error code. The first argument passed to `$fatal` shall be consistent with the argument to `$finish`.
- `$error` is a run-time error.
- `$warning` is a run-time warning, which can be suppressed in a tool-specific manner.
- `$info` indicates that the assertion failure carries no specific severity.

The syntax for these system tasks is shown in Section 23.8.

If an assertion fails and no **else** clause is specified, the tool shall, by default, call `$error`, unless a tool-specific option, such as a command-line option, is enabled to suppress the failure.

All of these severity system tasks shall print a tool-specific message indicating the severity of the failure, and specific information about the specific failure, which shall include the following information:

- The file name and line number of the assertion statement.
- The hierarchical name of the assertion, if it is labeled, or the scope of the assertion if it is not labeled.

For simulation tools, these tasks shall also include the simulation run-time at which the severity system task is called.

Each system task can also include additional user-specified information using the same format as the Verilog `$display`.

If more than one of these system tasks is included in the **else** clause, then each shall be executed as specified.

If the severity system task is executed at a time other than when the assertion fails, the actual failure time of the assertion can be recorded and displayed programmatically. For example:

```
time t;

always @(posedge clk)
  if (state == REQ)
    assert (req1 || req2)
    else begin
      t = $time;
      #5 $error("assert failed at time %0t",t);
    end
```

If the assertion fails at time 10, the error message shall be printed at time 15, but the user-defined string printed shall be "assert failed at time 10".

The display of messages of warning and info types can be controlled by a tool-specific option, such as a command-line option.

Since the fail statement, like the pass statement, is any legal SystemVerilog procedural statement, it can also be used to signal a failure to another part of the testbench.

```
assert (myfunc(a,b)) count1 = count + 1; else ->event1;
assert (y == 0) else flag = 1;
```

17.3 Concurrent assertions overview

Concurrent assertions describe behavior that spans over time. Unlike immediate assertions, the evaluation model is based on a clock such that a concurrent assertion is evaluated only at the occurrence of a clock tick. The values of variables used in the evaluation are the sampled values. This way, a predictable result can be obtained from the evaluation, regardless of the simulator's internal mechanism of ordering events and evaluating events. This model of execution also corresponds to the synthesis model of hardware interpretation from an RTL description.

The values of variables used in assertions are sampled in the Preponed region of a time slot and the assertions are evaluated during the Observe region. This is explained in Section 14, Scheduling Semantics.

The timing model employed in a concurrent assertion specification is based on clock ticks and uses a generalized notion of clock cycles. The definition of a clock is explicitly specified by the user and can vary from one expression to another.

A *clock tick* is an atomic moment in time ~~and implies that there is no duration of time in a clock tick that itself spans no duration of time. It is also given that a clock shall tick only once at any simulation time, and the sampled values for that simulation time are used for evaluation.~~ A clock shall tick only once at any simulation time and the sampled values for that simulation time are used for evaluation of concurrent assertions. In an assertion, the sampled value is the only valid value of a variable at a clock tick. Figure 17-1 shows the values of a variable as the clock progresses. The value of signal req is low at clock ticks 1 and 2. At clock tick 3, the value is sampled as high and remains high until clock tick 6. The sampled value of variable req at clock tick 6 is low and remains low until clock tick 10. Notice that, ~~at clock tick 9,~~ the simulation value transitions to high ~~at clock tick 9.~~ However, the sampled value ~~at clock tick 9~~ is low.

LRM 238

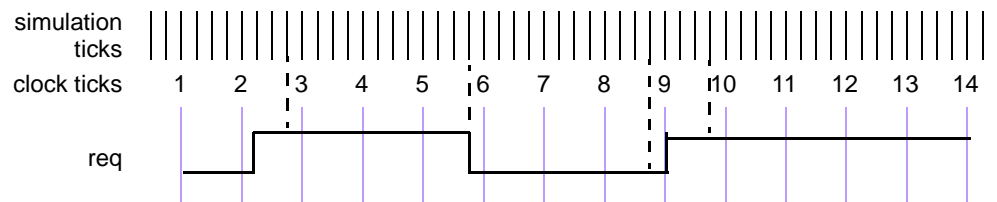

Figure 17-1 — Sampling a variable on simulation ticks

An expression used in an assertion is always tied to a clock definition. The sampled values are used to evaluate value change expressions or boolean sub-expressions that are required to determine a match ~~with respect to a sequence expression~~ of a sequence.

LRM 238

Note:

- It is important to ensure that the defined clock behavior is glitch free. Otherwise, wrong values can be sampled.
- If a variable that appears in the expression for clock also appears in an expression ~~for the with an~~ assertion, the values of the two usages of the variable can be different. The ~~current~~ value of the variable ~~is~~ used in the clock expression ~~is the current value~~, while ~~for~~ the sampled value of the variable is used within the assertion ~~the sampled value of the variable is used~~.

LRM 238

The clock expression that controls evaluation of a sequence can be more complex than just a single signal name. An expression such as `(clk && gating_signal) and (clk iff gating_signal)` could be used to represent a gated clock. Other more complex expressions are possible. In order to ensure proper behavior of the system and conform as closely as possible to truly cycle-based semantics, the signals in a clock expression must be glitch-free and should only transition once at any simulation time.

LRM 238

An example of a concurrent assertion is:

```
base_rule1: assert property (cont_prop(rst,in1,in2)) pass_stat else fail_stat;
```

The keyword **property** distinguishes a concurrent assertion from an immediate assertion. The syntax of concurrent assertions is discussed in 17.13.

17.4 Boolean expressions

The expressions used in sequences are evaluated over sampled values of the variables that appear in the expressions. The outcome of the evaluation of an expression is boolean and is interpreted the same way as an expression is interpreted in the condition of a procedural **if** statement. That is, if the expression evaluates to `x`, `z`, or `0`, then it is interpreted as being false. Otherwise, it is true.

LRM 238

There are certain restrictions on the expressions that can appear in concurrent assertions. The restrictions on operand types, variables, and operators are specified in the following sections.

Expressions are allowed to include function calls, but certain semantic restrictions are imposed.

LRM 210

- Functions that appear in expressions cannot contain output or **ref** arguments (**const ref** are allowed).
- Functions should be automatic (or preserve no state information) and have no side effects.

17.4.1 Operand types

The following types are not allowed:

- non-integer types (~~time~~, ~~shortreal~~, ~~real~~ and ~~realtime~~)
- **string**
- **event**
- **chandle**
- **class**
- associative arrays
- dynamic arrays

LRM 238

Fixed size arrays, packed or unpacked, can be used as a whole or as part selects or as indexed bit or part selects. The indices can be constants, parameters, or variables.

The following example shows some possible forms of comparison of ~~over~~ members of structures and unions:

LRM 238

```
typedef int [4] array;
typedef struct { int a, b, c,d } record;
union { record r; array a; } p, q;
```

The following comparisons are legal in expressions:

```
p.a == q.a
```

and

```
p.r == q.r
```

The following example provides further illustration of the use of arrays in expressions.

```
logic [7:0] arrayA [0:15], arrayB[0:15];
```

The following comparisons are legal:

```
arrayA == arrayB;  
arrayA != arrayB;  
arrayA[i] >= arrayB[j];  
arrayB[i][j+:2] == arrayA[k][m -:2];  
(arrayA[i] & (~arrayB[j])) == 0;
```

17.4.2 Variables

The variables that can appear in expressions must be static design variables or function calls returning values of types described in Section 17.4.1. Static variables declared in programs, interfaces or clocking blocks can also be accessed. If a reference is to a static variable declared in a task, that variable is sampled as any other variable, independent of calls to the task.

LRM 137

17.4.3 Operators

All operators that are valid for the types described in Section 17.4.1 are allowed with the exception of assignment operators ~~or~~ and increment and decrement operators. SystemVerilog includes the C assignment operators, such as +=, and the C increment and decrement operators, ++ and --. These operators cannot be used in expressions that appear in assertions. This restriction prevents side effects.

LRM 238

17.5 Sequences

```

sequence_expr ::= //from Annex A.2.10
    cycle_delay_range sequence_expr { cycle_delay_range sequence_expr }
  | sequence_expr cycle_delay_range sequence_expr { cycle_delay_range sequence_expr }
  | expression_or_dist [ boolean_abbrev ]
  | ( expression_or_dist { , sequence_match_item } ) [ boolean_abbrev ]
  | sequence_instance [ sequence_abbrev ]
  | ( sequence_expr { , sequence_match_item } ) [ sequence_abbrev ]
  | sequence_expr and sequence_expr
  | sequence_expr intersect sequence_expr
  | sequence_expr or sequence_expr
  | first_match ( sequence_expr { , sequence_match_item } )
  | expression_or_dist throughout sequence_expr
  | sequence_expr within sequence_expr
  | clocking_event sequence_expr

cycle_delay_range ::=
    ## constant_expression
    ## integral_number
  | ## identifier
  | ## ( constant_expression )
  | ## [ cycle_delay_const_range_expression ]

sequence_match_item ::=
    variable_assignment
  | subroutine_call

sequence_instance ::=
    ps_sequence_identifier [ ( [ actual_arg_list ] ) ]
formal_list_item ::= formal_identifier [ = actual_arg_expr ]
actual_arg_list ::=
    { actual_arg_expr { , actual_arg_expr } }
  | { . formal_identifier ( actual_arg_expr ) { , . formal_identifier ( actual_arg_expr ) } }

actual_arg_expr ::=
    event_expression
  | $

boolean_abbrev ::=
    consecutive_repetition
  | non_consecutive_repetition
  | goto_repetition

sequence_abbrev ::= consecutive_repetition
consecutive_repetition ::= [* const_or_range_expression ]
non_consecutive_repetition ::= [*= [= const_or_range_expression ]
goto_repetition ::= [*-> [-> const_or_range_expression ]

const_or_range_expression ::=
    constant_expression
  | cycle_delay_const_range_expression

cycle_delay_const_range_expression ::=
    constant_expression : constant_expression
  | constant_expression : $

expression_or_dist ::= expression [ dist { dist_list } ]

```

LRM 208
LRM 209
LRM 249
LRM 275
LRM 278

LRM 129
LRM 133

LRM 180

LRM 100

LRM 137

Syntax 17-2—Sequence syntax (excerpt from Annex A)

Properties are often constructed out of sequential behaviors. The **sequence** feature provides the capability to build and manipulate sequential behaviors. The simplest sequential behaviors are linear. A **sequence linear sequence** is a finite list of SystemVerilog boolean expressions in a linear order of increasing time. ~~The boolean expressions must be true at those specific clock ticks for the sequence to be true over time. A boolean expression at a point in time is a simple case of a sequence with time length of one clock cycle. To determine a match of a sequence, the boolean expressions are evaluated at each successive clock tick in an attempt to satisfy the sequence. If all expressions are true, then a match of the sequence occurs.~~ The linear sequence is said to match along a finite interval of consecutive clock ticks provided the first boolean expression evaluates to true at the first clock tick, the second boolean expression evaluates to true at the second clock tick, and so forth, up to and including the last boolean expression evaluating to true at the last clock tick. A single boolean expression is an example of a simple linear sequence, and it matches at a single clock tick provided the boolean expression evaluates to true at that clock tick.

LRM 238

~~A sequence expression describes one or more sequences by using regular expressions. Such a regular expression can concisely specify a set of zero, finitely many, or infinitely many sequences that satisfy the sequence expression.~~

More complex sequential behaviors are described by SystemVerilog sequences. A sequence is a regular expression over the SystemVerilog boolean expressions that concisely specifies a set of zero, finitely many, or infinitely many linear sequences. If at least one of the linear sequences from this set matches along a finite interval of consecutive clock ticks, then the sequence is said to match along that interval.

A property may involve checking of one or more sequential behaviors beginning at various times. An attempted evaluation of a sequence is a search for a match of the sequence beginning at a particular clock tick. To determine whether such a match exists, appropriate boolean expressions are evaluated beginning at the particular clock tick and continuing at each successive clock tick until either a match is found or it is deduced that no match can exist.

Sequences ~~and sequence expressions~~ can be composed by concatenation, analogous to a concatenation of lists. The concatenation specifies a delay, using ##, from the end of the first sequence until the beginning of the second sequence.

The following is the syntax for sequence concatenation.

```
sequence_expr ::=                                     // from Annex A.2.10
    cycle_delay_range sequence_expr { cycle_delay_range sequence_expr }
    | sequence_expr cycle_delay_range sequence_expr { cycle_delay_range sequence_expr }
    ...
cycle_delay_range ::=
    ## constant_expression
    ## integral_number
    | ## identifier
    | ## ( constant_expression )
    | ## [ cycle_delay_const_range_expression ]
cycle_delay_const_range_expression ::=
    constant_expression : constant_expression
    | constant_expression : $
```

LRM 275

Syntax 17-3—Sequence concatenation syntax (excerpt from Annex A)

In this syntax:

— *constant_expression* is computed at compile time and must result in an integer value.

- *constant_expression* can only be 0 or greater.
- The \$ token is used to indicate the end of simulation. For formal verification tools, \$ is used to indicate a finite, unbounded, range.
- When a range is specified with two expressions, the second expression must be greater or equal to the first expression.

The context in which a sequence occurs determines when the sequence is evaluated. The first expression in a sequence is checked at the first occurrence of the clock tick at or after the expression that triggered evaluation of the sequence. Each successive element (if any) in the sequence is checked at the next subsequent occurrence of the clock.

~~A ## followed by an optional number or range specifies that the *sequence_expr* should occur later than the current cycle. A number of 1 indicates that the next element should occur a single cycle later than the current cycle. The number 0 specifies that the next expression should occur in parallel with the current clock tick.~~

A ## followed by a number or range specifies the delay from the current cycle to the beginning of the sequence that follows. The delay ##1 indicates that the beginning of the sequence that follows is one clock tick later than the current cycle. The delay ##0 indicates that the beginning of the sequence that follows is at the same clock tick as the current cycle.

LRM 238

When used as a concatenation between two sequences, the delay is from the end of the first sequence to the beginning of the second sequence. The delay ##1 indicates that the beginning of the second sequence is one clock tick later than the end of the first sequence. The delay ##0 indicates that the beginning of the second sequence is at the same clock tick as the end of the first sequence.

The following are examples of delay expressions. ``true` is a boolean expression that always evaluates to true; and is used for visual clarity. It can be defined as:

```

`define true 1

##0 a      // means a
##1 a      // means `true ##1 a
##2 a      // means `true ##1 `true ##1 a
##[0:3]a   // means (a) or (`true ##1 a) or (`true ##1 `true ##1 a) or
            //      (`true ##1 `true ##1 `true ##1 a)
a ##2 b    // means a ##1 `true ##1 b

```

The sequence:

```
req ##1 gnt ##1 !req
```

specifies that `req` be true on the current clock tick, `gnt` shall be true on the first subsequent tick, and `req` shall be false on the next clock tick after that. The ##1 operator specifies one clock tick separation. A delay of more than one clock tick can be specified, as in:

```
req ##2 gnt
```

This specifies that `req` shall be true on the current clock tick, and `gnt` shall be true on the second subsequent clock tick, as shown in Figure 17-2.

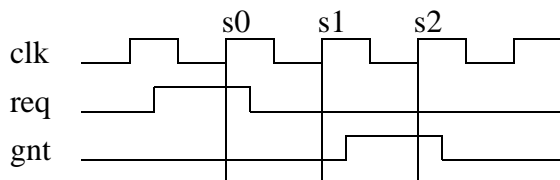

Figure 17-2 — Concatenation of sequences

The following specifies that signal `b` shall be true on the `N`th clock tick after signal `a`:

```
a ##N b // check b on the Nth sample
```

To specify a concatenation of overlapped sequences, where the end point of one sequence coincides with the start of the next sequence, a value of 0 is used, as shown below.

```
a ##1 b ##1 c // first sequence seq1
d ##1 e ##1 f // second sequence seq2
seq1 ##0 seq2 // overlapped concatenation
(a ##1 b ##1 c) ##0 (d ##1 e ##1 f) // overlapped concatenation
```

LRM 238

In the above example, `c` is must be true at the endpoint of sequence `seq1`, and `d` is must be true at the start of sequence `seq2`. When concatenated with 0 clock tick delay, `c` and `d` must ~~both~~ be true at the same time, resulting in a concatenated sequence equivalent to:

```
a ##1 b ##1 c&&d ##1 e ##1 f
```

It should be noted that no other form of overlapping between the sequences can be expressed using the concatenation operation.

In cases where the delay can be any value in a range, a time window can be specified as follows:

```
req ##[4:32] gnt
```

In the above case, signal `req` must be true at the current clock tick, and signal `gnt` must be true at some clock tick between the 4th and the 32nd clock tick after the current clock tick.

LRM 238

The time window can extend to a finite, but unbounded, range by using `$` as in the example below.

```
req ##[4:$] gnt
```

A sequence can be unconditionally extended by concatenation with ``true`.

```
a ##1 b ##1 c ##3 `true
```

After satisfying signal `c`, the sequence length is extended by 3 clock ticks. Such adjustments in the length of sequences can be required when complex sequences are constructed by combining simpler sequences.

17.6 Declaring sequences

A **sequence** can be declared in

- a module *as a module_or_generate_item*
- an interface *as an interface_or_generate_item*
- a program *as a non_port_program_item*
- a clocking block *as a clocking_item*
- a package
- a compilation-unit scope

LRM 240

LRM 137

LRM 58

Sequences are declared using the following syntax.:

```

concurrent_assertion_item_declaration ::=                               // from Annex A.2.10
    ...
    | sequence_declaration
sequence_declaration ::=
    sequence sequence_identifier [ sequence_formal_list ( [ list_of_formals ] ) ] ;
    { assertion_variable_declaration }
    sequence_spec
    sequence_expr ;
    endsequence [ : sequence_identifier ]
sequence_formal_list ::=
    ( formal_list_item { , formal_list_item } )
sequence_spec ::=
    multi_clock_sequence
    † sequence_expr
multi_clock_sequence ::=
    sequence_expr
    † clocking_event multi_clock_sequence
    † ( multi_clock_sequence )
    † multi_clock_sequence ## multi_clock_sequence
    † multi_clock_sequence cycle_delay_range multi_clock_sequence
sequence_instance ::=
    ps_sequence_identifier [ ( [ actual_arg_list ] ) ]
actual_arg_list ::=
    ( actual_arg_expr { , actual_arg_expr } )
    | ( . formal_identifier ( actual_arg_expr ) { , . formal_identifier ( actual_arg_expr ) } )
actual_arg_expr ::=
    event_expression
    | $
assertion_variable_declaration ::=
    data_type list_of_variable_identifiers ;

```

LRM 208
LRM 211
LRM 278

LRM 131

LRM 135

Syntax 17-4—Declaring sequence syntax (excerpt from Annex A)

The *clocking_event* specifies the clock for the sequence.

Formal arguments can be optionally specified. A formal argument is untyped, and is used for syntactic replacement of a name or an expression in the sequence.

An actual argument can replace an:

- identifier
- expression
- event control expression
- upper range as \$

LRM 135

Note that variables used in a sequence that are not formal arguments to the sequence are resolved according to the scoping rules from the scope in which the sequence is declared.

```

sequence s1;
    @(posedge clk) a ##1 b ##1 c;

```



```

endsequence
sequence s2;
  @(posedge clk) d ##1 e ##1 f;
endsequence
sequence s3;
  @(negedge clk) g ##1 h ##1 i;
endsequence

```

In this example, sequences `s1` and `s2` are evaluated on **each** successive posedge **event** of `clk`. The sequence `s3` is evaluated on **the successive** negedge **events** of `clk`.

LRM 238

Another example of sequence declaration **with, which includes** arguments is shown below:

```

sequence s20_1(data,en);
  (!frame && (data==data_bus)) ##1 (c_be[0:3] == en);
endsequence

```

Sequence `s20_1` does not specify a clock. In this case, a clock would be inherited from some external source, such as a **property** or an **assert** statement. A sequence can be referred to by its name. A hierarchical name can be used, consistent with the SystemVerilog naming conventions. A sequence can be referenced in a **property**, an **assert** statement, or a **cover** statement.

To use **sequence** a named sequence as a **sub-expression or a part of the expression** sub-sequence of another **sequence**, simply reference its name. The evaluation of a sequence **expression** that references a **named** sequence is performed **in** the same way as if the **named** sequence **expression contained in the sequence** was **contained as** a lexical part of the **expression referencing sequence**, with the formal arguments **substituted** **named sequence replaced** by the actual ones and the remaining variables **that were not arguments substituted from** **in the named sequence resolved according** to the scope of **the** declaration of the named sequence. An example is shown below:

LRM 238

```

sequence s;
  a ##1 b ##1 c;
endsequence
sequence rule;
  @(posedge sysclk)
  trans ##1 start_trans ##1 s ##1 end_trans;
endsequence

```

Sequence `rule` in the preceding example is equivalent to:

```

sequence rule;
  @(posedge sysclk)
  trans ##1 start_trans ##1 a ##1 b ##1 c ##1 end_trans ;
endsequence

```

Any form of syntactic cyclic dependency of the sequence names is disallowed. The example below illustrates an illegal dependency of `s1` on `s2` and `s2` on `s1`, because it creates a cyclic dependency.

```

sequence s1;
  @(posedge sysclk) (x ##1 s2);
endsequence
sequence s2;
  @(posedge sysclk) (y ##1 s1);
endsequence

```

17.7 Sequence operations

17.7.1 Operator precedence

Operator precedence and associativity ~~is~~ are listed in Table 17-1, below. The highest precedence is listed first.

LRM 238

Table 17-1: Operator precedence and associativity

SystemVerilog expression operators	Associativity
[*] [* -] [* ->] [*] [=] [->]	----
##	left
throughout	right
within	left
intersect	left
and	left
or	left

LRM 209

LRM 131

LRM 238

17.7.2 Repetition in sequences

Following is the syntax for sequence repetition.

```

sequence_expr ::=                                     // from Annex A.2.10
    ...
    | expression_or_dist [ boolean_abbrev ]
    | ( expression_or_dist { , sequence_match_item } ) [ boolean_abbrev ]
    | sequence_instance [ sequence_abbrev ]
    | ( sequence_expr { , sequence_match_item } ) [ sequence_abbrev ]
    ...
boolean_abbrev ::=
    consecutive_repetition
    | non_consecutive_repetition
    | goto_repetition
sequence_abbrev ::= consecutive_repetition
consecutive_repetition ::= [* const_or_range_expression ]
non_consecutive_repetition ::= [*=> [= const_or_range_expression ]
goto_repetition ::= [*-> [-> const_or_range_expression ]
const_or_range_expression ::=
    constant_expression
    | cycle_delay_const_range_expression
cycle_delay_const_range_expression ::=
    constant_expression : constant_expression
    | constant_expression : $

```

LRM 209

LRM 129

LRM 133

LRM 180

LRM 100

Syntax 17-5—Sequence repetition syntax (excerpt from Annex A)

~~The repetition counts are specified as a range and the minimum and maximum range expressions must be literals or constant expressions.~~

The number of iterations of a repetition can either be specified by exact count or be required to fall within a finite range. If specified by exact count, then the number of iterations is defined by a non-negative integer constant expression. If required to fall within a finite range, then the minimum number of iterations is defined by a non-negative integer constant expression and the maximum number of iterations is either defined by a non-negative integer constant expression or is \$, indicating a finite, but unbounded maximum.

If both the minimum and maximum numbers of iterations are defined by non-negative integer constant expressions, then the minimum number must be less than or equal to the maximum number.

Three kinds of repetition are provided:

- ~~consecutive repetition ([*]), where a sequence is consecutively repeated with one cycle delay between the repetitions:~~ Consecutive repetition specifies finitely many iterative matches of the operand sequence, with a delay of one clock tick from the end of one match to the beginning of the next. The overall repetition sequence matches at the end of the last iterative match of the operand. LRM 238
- ~~goto repetition ([*-> [->]), where a boolean expression is repeated with one or more cycle delays between the repetitions and the resulting sequence terminates at the last boolean expression:~~ Goto repetition specifies finitely many iterative matches of the operand boolean expression, with a delay of one or more clock ticks from one match of the operand to the next successive match and no match of the operand strictly in between. The overall repetition sequence matches at the last iterative match of the operand. LRM 209
LRM 238
- ~~non-consecutive repetition ([*= [=]), where a boolean expression is repeated with one or more cycle delays between the repetitions and the resulting sequence can proceed beyond the last boolean expression, but before the occurrence of the boolean expression:~~ Non-consecutive repetition specifies finitely many iterative matches of the operand boolean expression, with a delay of one or more clock ticks from one match of the operand to the next successive match and no match of the operand strictly in between. The overall repetition sequence matches at or after the last iterative match of the operand, but before any later match of the operand.

~~To specify the consecutive repetition of an expression within a sequence, the expression can simply be repeated, as:~~ The effect of consecutive repetition of a sub-sequence within a sequence can be achieved by explicitly iterating the sub-sequence, as: LRM 238

```
a ##1 b ##1 b ##1 b ##1 c
```

~~Or the number of repetitions can be specified with [*N], as:~~ Using the consecutive repetition operator [*3], which indicates 3 iterations, this sequential behavior is specified more succinctly:

```
a ##1 b [*3] ##1 c
```

~~A consecutive repetition specifies that the item or expression must occur a specified number of times. A consecutive repetition specifies that the operand sequence must match a specified number of times. Each repeated item is concatenated (with a delay of 1 clock tick) to the next repeated item. A repeat of N specifies that the sequence must occur N times in succession. The consecutive repetition operator [*N] specifies that the operand sequence must match N times in succession. For example:~~

```
a [*3] means a ##1 a ##1 a
```

Using 0 as the repetition number, an empty sequence results, as:

```
a [*0]
```

~~An empty sequence shall be illegal.~~

An *empty sequence* is one that does not match over any positive number of clocks. The following rules apply

for concatenating sequences with empty sequences. An empty sequence is denoted as *empty* and a sequence is denoted as *seq*.

- (*empty* ##0 *seq*) does not result in a match
- (*seq* ##0 *empty*) does not result in a match
- (*empty* ##n *seq*), where n is greater than 0, is equivalent to (##(n-1) *seq*)
- (*seq* ##n *empty*), where n is greater than 0, is equivalent to (*seq* ##(n-1) 'true)

For example,

```
b ##1 ( a[*0] ##0 c)
```

produces no match of the sequence.

```
b ##1 a[*0:1] ##2 c
```

is equivalent to

```
(b ##2 c) or (b ##1 a ##2 c)
```

The syntax allows combination of a delay and repetition in the same sequence. The following are both allowed:

```
'true ##3 (a [*3]) // means 'true ##1 'true ##1 'true ##1 a ##1 a ##1 a
('true ##2 a) [*3] // means ('true ##2 a) ##1 ('true ##2 a) ##1
// ('true ##2 a), which in turn means 'true ##1 'true ##1
// a ##1 'true ##1 'true ##1 a ##1 'true ##1 'true ##1 a
```

A sequence can be repeated as follows:

```
(a ##2 b) [*5]
```

~~Which~~ This is the same as:

```
(a ##2 b ##1 a ##2 b ##1 a ##2 b ##1 a ##2 b ##1 a ##2 b)
```

LRM 209
LRM 238

A repetition with a range of ~~maximum~~ min minimum and ~~minimum~~ max maximum number of ~~times~~ iterations can be expressed with the consecutive repetition operator [* min:max]. ~~As an example, the following two expressions are equivalent.~~

As an example,

```
(a ##2 b) [*1:5]
```

is equivalent to

```
(a ##2 b)
or (a ##2 b ##1 a ##2 b)
or (a ##2 b ##1 a ##2 b ##1 a ##2 b)
or (a ##2 b ##1 a ##2 b ##1 a ##2 b ##1 a ##2 b)
or (a ##2 b ##1 a ##2 b ##1 a ##2 b ##1 a ##2 b ##1 a ##2 b)
```

~~The following two expressions are also equivalent.~~ Similarly,

```
(a[*0:3] ##1 b ##1 c)
```

is equivalent to

```
(b ##1 c)
or (a ##1 b ##1 c)
or (a ##1 a ##1 b ##1 c)
or (a ##1 a ##1 a ##1 b ##1e ##1 c)
```

To specify a ~~potentially infinite~~ finite, but unbounded, number of ~~repetitions~~ iterations, the dollar sign (\$) is used. ~~The~~ For example, the repetition:

```
a ##1 b [*1:$] ##1 c
```

~~means a is true on the current sample, then b shall be true on every subsequent sample until c is true. On the sample in which c is true, b does not have to be true.~~ matches over an interval of three or more consecutive clock ticks if a is true on the first clock tick, c is true on the last clock tick, and b is true at every clock tick strictly in between the first and the last.

Specifying the number of iterations of a repetition by exact count is equivalent to specifying a range in which the minimum number of repetitions is equal to the maximum number of repetitions. In other words, `seq[*n]` is equivalent to `seq[*n:n]`.

The *goto repetition* (non-consecutive exact repetition) takes a boolean expression rather than a sequence as operand. It specifies the iterative matching of the boolean expression at clock ticks that are not necessarily consecutive and ends at the last iterative match. For example,

```
a ##1 b [->2:10] ##1 c
```

matches over an interval of consecutive clock ticks provided a is true on the first clock tick, c is true on the last clock tick, b is true on the penultimate clock tick, and, including the penultimate, there are at least 2 and at most 10 not-necessarily-consecutive clock ticks strictly in between the first and last on which b is true. This sequence is equivalent to:

```
a ##1 ((!b[*0:$] ##1 b) [*2:10]) ##1 c
```

The *non-consecutive repetition* is like the goto repetition except that a match does not have to end at the last iterative match of the operand boolean expression. The use of non-consecutive repetition instead of goto repetition allows the match to be extended by arbitrarily many clock ticks provided the boolean expression is false on all of the extra clock ticks. For example,

```
a ##1 b [=2:10] ##1 c
```

matches over an interval of consecutive clock ticks provided a is true on the first clock tick, c is true on the last clock tick, and there are at least 2 and at most 10 not-necessarily-consecutive clock ticks strictly in between the first and last on which b is true. This sequence is equivalent to:

```
a ##1 ((!b [*0:$] ##1 b) [*2:10]) ##1 !b[*0:$] ##1 c
```

~~The rules for specifying repeat counts are summarized as:~~

- ~~— Each form of repeat count specifies a minimum and maximum number of occurrences~~
- ~~— expression `[*m:n]`, where m is the minimum, n is the maximum, and $m \geq 0$, $m \leq n$ or n is \$~~
- ~~— expression `[*n]` is the same as expression `[*n:n]`~~
- ~~— The sequence as a whole cannot be empty~~
- ~~— If n is 0, then there must be either a prefix, or a suffix concatenation term (i.e., not the only term in the expression) to the repeated sequence~~
- ~~— The match shall not be empty~~

LRM 178

~~The `[*N]` notation indicates consecutive repetition of an expression.~~

The *goto repetition* (non-consecutive exact repetition) specifies the repetition of a boolean expression, such as:

```
a ##1 b [*->min:max] ##1 c
```

This is equivalent to:

```
a ##1 ((!b [*0:$] ##1 b) [*min:max]) ##1 c
```

LRM 178

Adding the range specification to this allows the construction of useful sequences containing a boolean expression that is true for at most N occurrences:

```
a ##1 b [*->1:N] ##1 c //a followed by at most N occurrences of b, followed by c
```

The *non-consecutive repetition* extends the *goto repetition* by extra clock ticks where the boolean expression is not true:

```
a ##1 b [*=min:max] ##1 c
```

This is equivalent to:

```
a ##1 ((!b [*0:$] ##1 b) [*min:max]) ##1 !b [*0:$] ##1 c
```

LRM 178

The above expression would pass the following sequence, assuming that 3 is within the min:max range:

```
a c c c e b c e b e b d d d e
```

17.7.3 Sampled value functions

LRM 134

This section describes the system functions available for accessing sampled values of an expression. These functions include the capability to access current sampled value, access sampled value in the past, or detect changes in sampled value of an expression. Sampling of an expression is explained in Section 17.3. The following functions are provided.

```
$sampled(expression [, clocking_event])
```

LRM 238

```
$rose( expression [, clocking_event])
```

```
$fell( expression [, clocking_event])
```

```
$stable( expression [, clocking_event])
```

```
$past( expression1 [, number_of_ticks] [, expression2] [, clocking_event])
```

The use of these functions is not limited to assertion features; they can be used as expressions in procedural code as well. The clocking event, although optional as an explicit argument to the functions, is required for their semantics. The clocking event is used to sample the value of the argument expression.

The clocking event must be explicitly specified as an argument, or inferred from the code where it is used. The following rules are used to infer the clocking event:

- if used in an assertion, the appropriate clocking event from the assertion is used.
- if used in an action block of a singly-clocked assertion, the clock of the assertion is used.
- if used in a procedural block, the inferred clock, if any, for the procedural code (Section 17.13.5) is used.

LRM 238

Otherwise, default clocking (Section 15.11) is used.

When these functions are used in an assertion, the clocking event argument of the functions, if specified, shall be identical to the clocking event of the expression in the assertion. In the case of multi-clock assertion, the

appropriate clocking event for the expression where the function is used, is applied to the function.

Function `$sampled` returns the sampled value of the expression with respect to the last occurrence of the clocking event. When `$sampled` is invoked prior to the occurrence of the first clocking event, the value of `X` is returned. The use of `$sampled` in assertions, although allowed, is redundant, as the result of the function is identical to the sampled value of the expression itself used in the assertion.

Three functions are provided to detect changes in sampled values: `$rose`, `$fell` and `$stable`.

A value change function detects the change in the sampled value of an expression. The clocking event is used to obtain the sampled value of the argument expression at a clock tick prior to the current simulation time unit. Here, the current simulation time unit refers to the simulation time unit in which the function is evaluated. This sampled value is compared against the value of the expression determined at the preponetime of the current simulation time unit. The result of a value change expression is true or false and can be used as a boolean expression.

`$rose` returns true if the least significant bit of the expression changed to 1. Otherwise, it returns false.

`$fell` returns true if the least significant bit of the expression changed to 0. Otherwise, it returns false.

`$stable` returns true if the value of the expression did not change. Otherwise, it returns false.

When these functions are **used called at or before the first clock tick of the clocking event, determined by the clocking event, or before the first clock tick**, the results of these functions are computed by comparing the current sampled value of the expression to `X`.

LRM 134
LRM 238

Figure 17-3 illustrates two examples of value changes:

- Value change expression `e1` is defined as `$rose(req)`
- Value change expression `e2` is defined as `$fell(ack)`

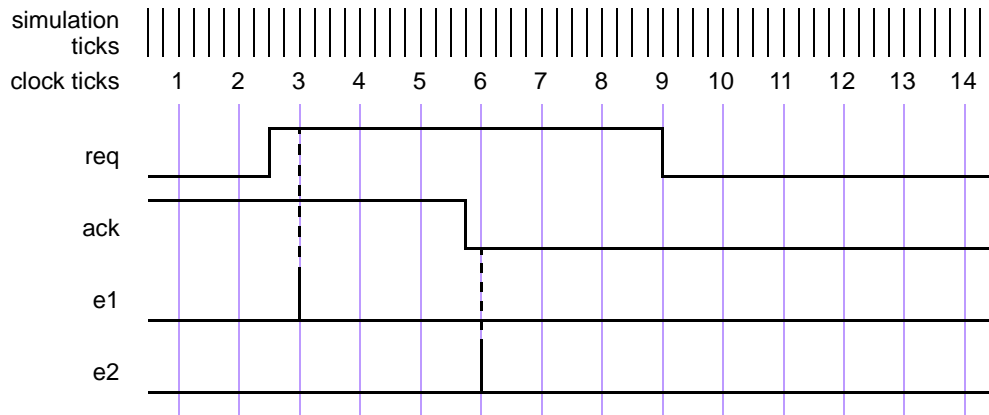

Figure 17-3 — Value change expressions

The clock ticks used for sampling the variables are derived from the clock for the property, which is different from the simulation ticks. Assume, for now, that this clock is defined elsewhere. At clock tick 3, `e1` occurs because the value of `req` at clock tick 2 was low and at clock tick 3, the value is high. Similarly, `e2` occurs at clock tick 6 because the value of `ack` was sampled as high at clock tick 5 and sampled as low at clock tick 6.

The example below illustrates the use of `$rose` in SystemVerilog code outside assertions.

LRM 134

```
always @(posedge clk)
    reg1 <= a & $rose(b);
```

In this example, the clocking event (`posedge clk`) is applied to `$rose`. `$rose` is true whenever the sampled value of `b` changed to 1 from its sampled value at the previous tick of the clocking event.

In addition to accessing value changes, the past values can be accessed with the `$past` function. The following three optional arguments are provided:

- expression2* is used as a gating expression for the clocking event
- number_of_ticks* specifies the number of clock ticks in the past
- clocking_event* specifies the clocking event for sampling expression1

expression1 and *expression2* can be any expression allowed in assertions.

number_of_ticks must be one or greater. If *number_of_ticks* is not specified, then it defaults to 1. `$past` returns the sampled value of the expression that was present *number_of_ticks* prior to the time of evaluation of `$past`. A clock tick is based on `clocking_event`. If the specified clock tick in the past is before the start of simulation, the returned value from the `$past` function is a value of X.

The optional argument *clocking_event* specifies the clock for the function. The rules governing the usage of *clocking_event* are same as those described for the value change function.

When intermediate optional arguments between two arguments are not needed, a comma must be placed for each omitted argument. For example,

```
$past(in1, , enable);
```

Here, a comma is specified to omit *number_of_ticks*. The default of one is used for the empty *number_of_ticks* argument. Note that a comma for the omitted *clocking_event* argument is not needed, as it does not fall within the specified arguments.

`$past` can be used in any System Verilog expression. An example is shown below.

```
always @(posedge clk)
    reg1 <= a & $past(b);
```

In this example, the clocking event (`posedge clk`) is applied to `$past`. `$past` is evaluated in the current occurrence of (`posedge clk`), and returns the value of `b` sampled at the previous occurrence of (`posedge clk`).

When *expression2* is specified, the sampling of *expression1* is performed based on its clock gated with *expression2*. For example,

LRM 238

```
always @(posedge clk)
    if (enable) q <= d;

always @(posedge clk)
    assert (done | => (out == $past(q, 2, enable)) );
```

In this example, the sampling of `q` for evaluating `$past` is based on the clocking expression

```
posedge clk iff enable
```

17.7.4 AND operation

The binary operator `and` is used when both *operand-expressions* operands are expected to *succeed match*, but the end times of the operand *expressions* sequences can be different.

LRM 210

```
sequence_expr ::= // from Annex A.2.10
    ...
    | sequence_expr and sequence_expr
```

Syntax 17-6—*and* operator syntax (excerpt from Annex A)

The two operands of **and** are **sequence expressions** sequences. The requirement for the **success match** of the **and** operation is that both the **operand expressions** operands must **succeed match**. The operand **expressions** sequences start at the same time. When one of the operand **expressions** sequences **succeeds matches**, it waits for the other to **succeed match**. The end time of the composite **expression** sequence is the end time of the operand **expression** sequence that completes last.

LRM 210
LRM 238

When *te1* and *te2* are sequences, then the **expression** composite sequence:

```
te1 and te2
```

- **Succeeds Matches** if *te1* and *te2* **succeed match**.
- The end time is the end time of either *te1* or *te2*, whichever **terminates matches** last.

The following example is **an expression** a sequence with **the and** operator **and**, where the two operands are **single** sequences **evaluations**.

LRM 178

```
(te1 ##2 te2) and (te3 ##2 te4 ##2 te5)
```

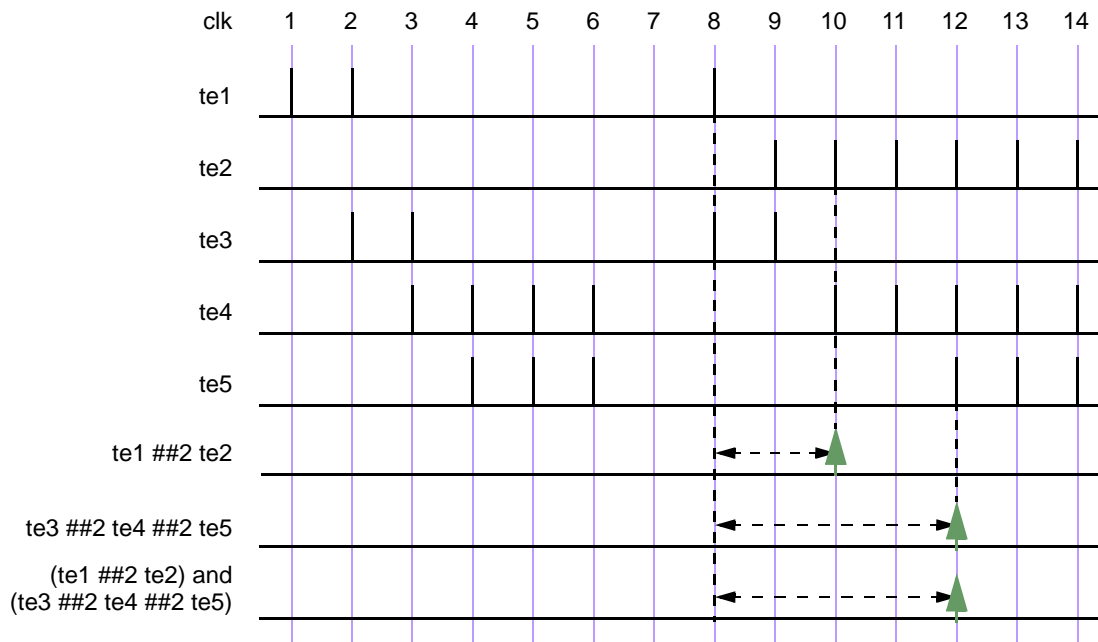

Figure 17-4 — ANDing (**and**) two sequences

The operation as illustrated in Figure 17-4 shows the evaluation attempt at clock tick 8. Here, the two operand sequences are (*te1* ##2 *te2*) and (*te3* ##2 *te4* ##2 *te5*). The first operand sequence requires that first *te1* evaluates to true followed by *te2* two clock ticks later. The second sequence requires that first *te3* evaluates to true followed by *te4* two clock ticks later, followed by *te5* two clock ticks later.

LRM 178

This attempt results in a match since both operand sequences match. The end times of matches for the individ-

ual sequences are clock ticks 10 and 12. The end time for the ~~entire expression~~ composite sequence is the ~~last~~ later of the two end times, so a match is recognized for the ~~expression~~ composite sequence at clock tick 12.

In the following example, ~~an~~ the first operand sequence is associated with a range of time specification, such as has a concatenation operator with range from 1 to 5:

```
(te1 ##[1:5] te2) and (te3 ##2 te4 ##2 te5)
```

~~The first operand sequence consists of an expression with a time range from 1 to 5 and implies that when te1 evaluates to true, te2 must follow 1, 2, 3, 4, or 5 clock ticks later. The second operand sequence is the same as in the previous example. To consider all possibilities of a match, the following steps are taken:~~

The first operand sequence requires that te1 evaluate to true and that te2 evaluate to true 1, 2, 3, 4, or 5 clock ticks later. The second operand sequence is the same as in the previous example. To consider all possibilities of a match of the composite sequence, the following steps can be taken:

- 1) ~~The first operand sequence starts five sequences of evaluation.~~ Five threads of evaluation are started for the five possible linear sequences associated with the first sequence operand.
- 2) The second operand sequence has only one ~~possibility for a match, so only one sequence is started~~ associated linear sequence, so only one thread of evaluation is started for it.
- 3) Figure 17-5 shows the ~~evaluation attempt to examine~~ beginning at clock tick 8 ~~when both operand sequences start and succeed~~. All five linear sequences for the first operand sequence match, as shown in a time window, so there are five matches of the first operand sequence, ending at clock ticks 9, 10, 11, 12 and 13 respectively. The second operand sequence matches at clock tick 12.
- 4) ~~To compute the result for the composite expression, each successful sequence from the first operand sequence is matched against the second operand sequence according to the rules of the and operation to determine the end time for each match.~~ Each match of the first operand sequence is combined with the single match of the second operand sequence, and the rules of the and operation determine the end time of the resulting match of the composite sequence.

The result of this computation is five ~~successes~~ matches of the composite sequence, four of them ending at clock tick 12, and the fifth ~~ends ending~~ ending at clock tick 13. Figure 17-5 shows the ~~two unique successes~~ matches of the composite sequence ending at clock ticks 12 and 13.

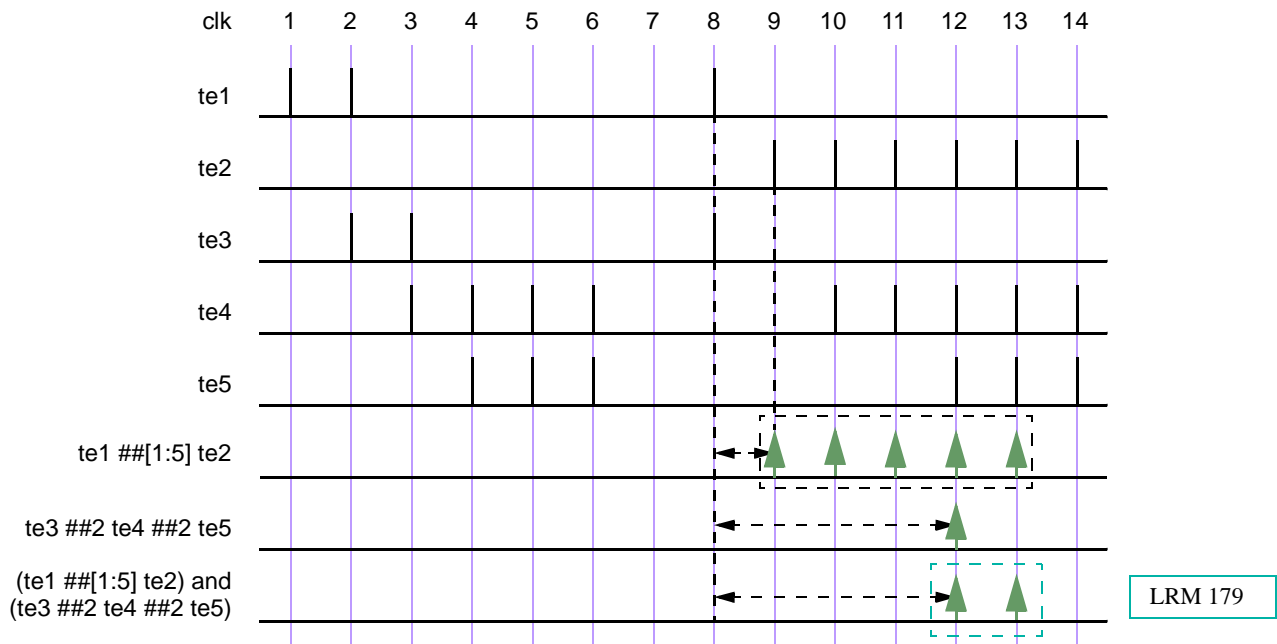

Figure 17-5 — ANDing (and) two sequences, including a time range

If `te1` and `te2` are sampled **boolean**s expressions (not sequences), the **expression** sequence (`te1 and te2`) **succeeds** matches if `te1` and `te2` **are** both **evaluated** evaluate to be true.

LRM 210
LRM 238

An example is illustrated in Figure 17-6, which shows the results for **an attempt** attempts at every clock tick. The **expression** sequence matches at clock tick 1, 3, 8, and 14 because both `te1` and `te2` are simultaneously true. At all other clock ticks, **match** of the **and** operation fails because either `te1` or `te2` is false.

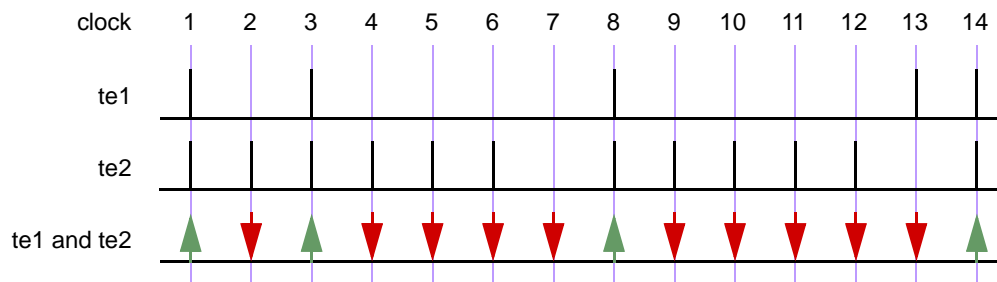

Figure 17-6 — ANDing (and) two boolean expressions

17.7.5 Intersection (AND with length restriction)

The binary operator **intersect** is used when both operand **expressions** sequences are expected to **succeed** match, and the end times of the operand **expressions** sequences must be the same.

LRM 210

```
sequence_expr ::= // from Annex A.2.10
    ...
    | sequence_expr intersect sequence_expr
```

Syntax 17-7—*intersect* operator syntax (excerpt from Annex A)

The two operands of **intersect** are **sequence-expressions** sequences. The requirements for **the success match** of the **intersect** operation are:

LRM 210
LRM 238

- Both the **operand-expressions** operands must **succeed match**.
- The **length lengths** of the two **matches of the** operand sequences must be the same.

The additional requirement on the length of the sequences is the basic difference between **and** and **intersect**.

~~For each attempted evaluation of *sequence_expr*, there could be multiple matches. When there are multiple matches for each operand sequence-expression, the results are computed as follows.~~ An attempted evaluation of an **intersect** sequence can result in multiple matches. The results of such an attempt can be computed as follows.

LRM 238

- ~~A match from the first operand is paired with a match from the second operand with the same length.~~ Matches of the first and second operands that are of the same length are paired. Each such pair results in a match of the composite sequence, with length and endpoint equal to the shared length and endpoint of the paired matches of the operand sequences.
- If no such pair is found, ~~the result of intersect is no match~~ then there is no match of the composite sequence.
- ~~If such pairs are found, then the result consists of matched sequences, one for each pair. The end time of each match is determined by the length of the pair.~~

Figure 17-7 is similar to Figure 17-5, except that **and** is replaced by **intersect**. ~~Compared with Figure 17-5, there is only a single match in this case.~~ In this case, unlike in Figure 17-5, there is only a single match at clock tick 12.

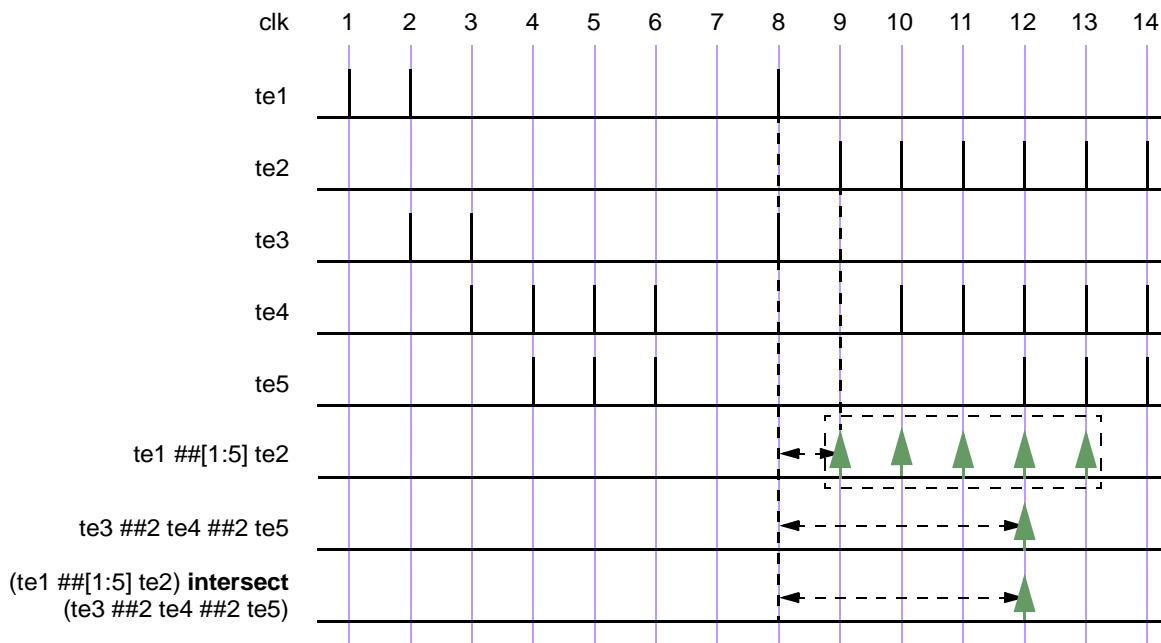

Figure 17-7 — Intersecting two sequences

17.7.6 OR operation

The operator `or` is used when at least one of the two operand sequences is expected to match.

```
sequence_expr ::= // from Annex A.2.10
    ...
    | sequence_expr or sequence_expr
```

Syntax 17-8—`or` operator syntax (excerpt from Annex A)

The two operands of `or` are ~~sequence-expressions~~ sequences.

LRM 238

For the expression: If the operands `te1` and `te2` are expressions, then

```
te1 or te2
```

~~when operands `te1` and `te2` are expressions, the sequence matches whenever at least one of two operands `te1` and `te2` is evaluated to true.~~ matches at any clock tick on which at least one of `te1` and `te2` evaluates to true.

Figure 17-8 illustrates an `or` operation ~~using for which the operands `te1` and `te2` as simple values are expressions.~~ The ~~expression composite~~ sequence does not match at clock ticks 7 and 13 because `te1` and `te2` are both false at those times. At all other ~~times~~ clock ticks, the ~~expression composite~~ sequence matches, as at least one of the two operands ~~is evaluated to true.~~

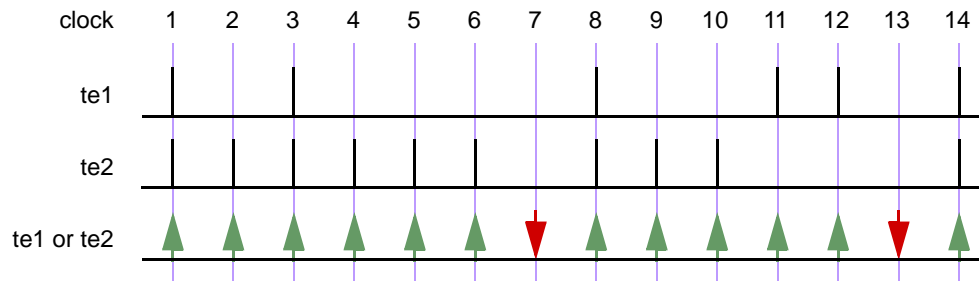

Figure 17-8 — ORing (or) Two Sequences

When `te1` and `te2` are sequences, then the ~~expression~~ sequence

```
te1 or te2
```

~~matches if at least one of the two operand sequences `te1` and `te2` match. To evaluate this expression, first, the successfully matched sequences of each operand are calculated and assigned to a group. Then, the union of the two groups is computed. The result of the union provides the result of the expression. The end time of a match is the end time of any sequence that matched.~~

matches if at least one of the two operand sequences `te1` and `te2` matches. Each match of either `te1` or `te2` constitutes a match of the composite sequence, and its end time as a match of the composite sequence is the same as its end time as a match of `te1` or of `te2`. In other words, the set of matches of `te1 or te2` is the union of the set of matches of `te1` with the set of matches of `te2`.

The following example shows ~~an expression~~ a sequence with ~~or~~ operator `or`, where the two operands are sequences. Figure 17-9 illustrates this example.

```
(te1 ##2 te2) or (te3 ##2 te4 ##2 te5)
```

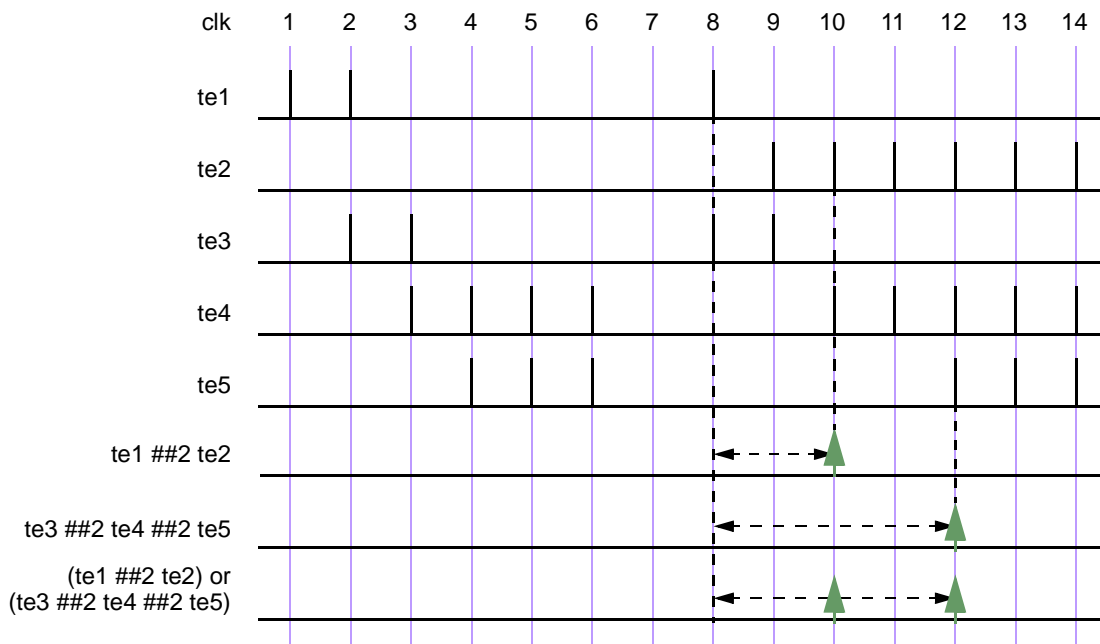

Figure 17-9 — ORing (or) two sequences

Here, the two operand sequences are: `(te1 ##2 te2)` and `(te3 ##2 te4 ##2 te5)`. The first sequence requires that `te1` first evaluates to true, followed by `te2` two clock ticks later. The second sequence requires that `te3` evaluates to true, followed by `te4` two clock ticks later, followed by `te5` two clock ticks later. In Figure 17-9, the evaluation attempt for clock tick 8 is shown. The first sequence matches at clock tick 10 and the second sequence matches at clock tick 12. So, two matches for the **expression composite sequence** are recognized.

In the next example, an operand sequence is associated with a time range specification, such as: In the following example, the first operand sequence has a concatenation operator with range from 1 to 5

```
(te1 ##[1:5] te2) or (te3 ##2 te4 ##2 te5)
```

The first operand sequence consists of an expression with a time range from 1 to 5 and specifies that when `te1` evaluates to true, `te2` must be true 1, 2, 3, 4, or 5 clock ticks later. The sequences from the second operand require that first `te3` must be true followed by `te4` being true two clock ticks later, followed by `te5` being true two clock ticks later. At any clock tick if an operand sequence succeeds, then the composite expressions succeeds. As shown in Figure 17-10, for the attempt at clock tick 8, the first operand sequence matches at clock ticks 9, 10, 11, 12, and 13, while the second operand matches at clock tick 12. The match of the composite expression is computed as a union of the matches of the two operand sequences, which results in matches at clock ticks 9, 10, 11, 12, and 13.

The first operand sequence requires that `te1` evaluate to true and that `te2` evaluate to true 1, 2, 3, 4, or 5 clock ticks later. The second operand sequence requires that `te3` evaluate to true, that `te4` evaluate to true 2 clock ticks later, and that `te5` evaluate to true another 2 clock ticks later. The composite sequence matches at any clock tick on which at least one of the operand sequences matches. As shown in Figure 17-10, for the attempt at clock tick 8, the first operand sequence matches at clock ticks 9, 10, 11, 12, and 13, while the second operand matches at clock tick 12. The composite sequence therefore has one match at each of clock ticks 9, 10, 11, and 13 and has two matches at clock tick 12.

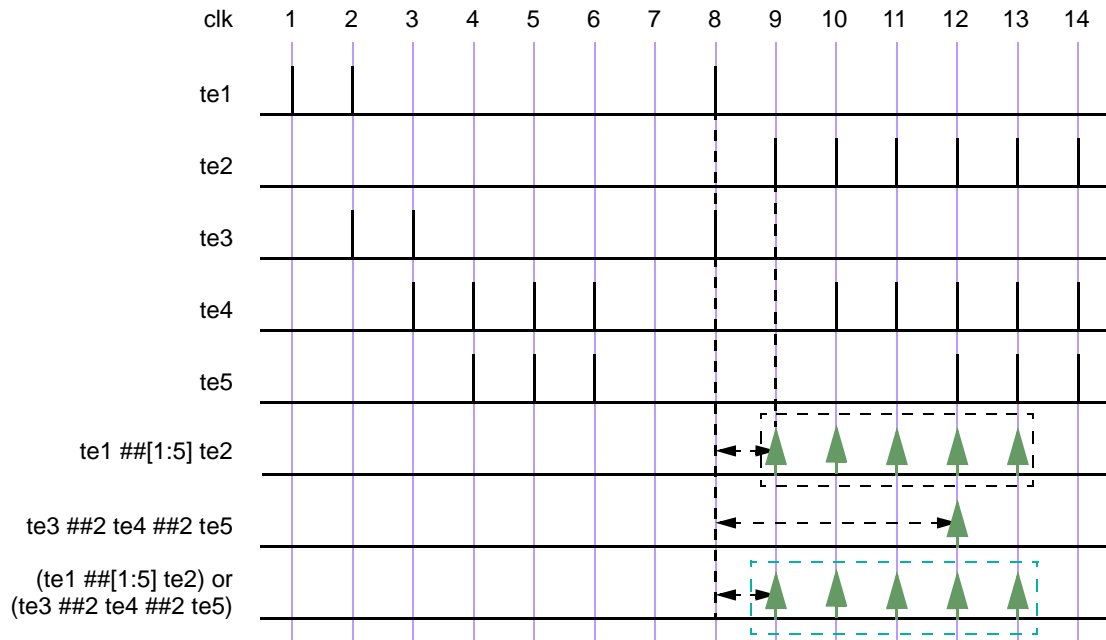

LRM 179

Figure 17-10 — ORing (or) two sequences, including a time range

17.7.7 first_match operation

The **first_match** operator matches only the first **match** of possibly multiple matches for an evaluation attempt of **a its operand sequence-expression**. This allows all subsequent matches to be discarded from consideration. In particular, when **the a sequence expression** is a **sub-expression sub-sequence** of a larger **expression sequence**, then applying the **first_match** operator has significant effect on the evaluation of the **embedding expression enclosing sequence**.

LRM 238

```
sequence_expr ::= //from Annex A.2.10
    ...
    | first_match ( sequence_expr { , sequence_match_item } )
```

LRM 208

Syntax 17-9—first_match operator syntax (excerpt from Annex A)

~~The operand expression can be a sequence expression. sequence_expr is evaluated to determine the match for the (first_match (sequence_expr)) expression. For a given evaluation attempt, the composite expression matches if sequence_expr results in at least one match of a sequence and fails to match if none of the sequences from the expression result in a match. Following the first successful match for the attempt, the first_match operator stops matching subsequent sequences for sequence_expr. For an attempt, if there are multiple matches with the same end-time as the first detected match, then all those matches are considered as the result of the expression.~~

An evaluation attempt of **first_match (seq)** results in an evaluation attempt for the operand **seq** beginning at the same clock tick. If the evaluation attempt for **seq** produces no match, then the evaluation attempt for **first_match (seq)** produces no match. Otherwise, the match of **seq** with earliest ending clock tick is a match of **first_match (seq)**. If there are multiple matches of **seq** with the same ending clock tick as the earliest one, then all those matches are matches of **first_match (seq)**.

LRM 238

The example below shows a variable delay specification.

SystemVerilog 3.1a/draft 5

```
sequence t1;
    te1 ##[2:5]te2 ## [2:5] te2;
endsequence
sequence ts1;
    first_match(te1 ##[2:5]te2 ## [2:5] te2);
endsequence
```

Here, `te1` and `te2` are expressions. Each attempt of sequence `t1` can result in matches for up to four of the following sequences:

```
te1 ##2 te2
te1 ##3 te2
te1 ##4 te2
te1 ##5 te2
```

However, sequence `ts1` can result in a match for only one of the above four sequences. Whichever match of the above four sequences matches ends first becomes the result is a match of sequence ~~`ts1`~~ `ts1`.

As another example:

```
sequence t2;
    (a ##[2:3] b) or (c ##[1:2] d);
endsequence
sequence ts2;
    first_match(t2);
endsequence
```

Each attempt of sequence `t2` can result in matches for up to four of the following sequences:

```
a ##2 b
a ##3 b
c ##1 d
c ##2 d
```

~~Sequence `ts2` results in the earliest match. In this case, it is possible to have two matches ending at the same time.~~ Sequence `ts2` matches only the earliest ending match of these sequences. If `a`, `b`, `c`, and `d` are expressions, then it is possible to have matches ending at the same time for both.

```
a ##2 b
c ##2 d
```

~~In this case, `first_match` results in two sequences.~~ If both of these sequences match and `(c ##1 d)` does not match, then evaluation of `ts2` results in these two matches.

17.7.8 Conditions over sequences

Sequences often occur under the assumptions of some conditions for correct behavior. A logical condition must hold true, for instance, while processing a transaction. Also, occurrence of certain values is prohibited while processing a transaction. Such situations can be expressed directly using the following construct:

```
sequence_expr ::= // from Annex A.2.10
    ...
    | expression_or_dist throughout sequence_expr
```

LRM 208

Syntax 17-10—throughout construct syntax (excerpt from Annex A)

~~expression must evaluate true at every clock tick during the evaluation of `sequence_expr`. If an evaluation of~~

LRM 238

~~*sequence_expr* starts at time t_1 and ends with a match at time t_2 , then for *sequence_expr* to match, expression must hold true from time t_1 to t_2 .~~

The ~~throughout~~ construct is an abbreviation for writing:

~~(expression) [*0:\$] **intersect** sequence_expr~~

~~In the following example, illustrated in Figure 17-11, if a constraint were placed on the expression as shown below, then the checker *burst_rule1* would fail at clock tick 9.~~

The construct `exp throughout seq` is an abbreviation for:

`(exp) [*0:$] intersect seq`

LRM 238

The composite sequence, `exp throughout seq`, matches along a finite interval of consecutive clock ticks provided `seq` matches along the interval and `exp` evaluates to true at each clock tick of the interval.

The following example is illustrated in Figure 17-11.

```
sequence burst_rule1;
  @(posedge mclk)
    $fell(burst_mode) ##0
    (!burst_mode) throughout (##2 ((trdy==0)&&(irdy==0)) [*7]);
endsequence
```

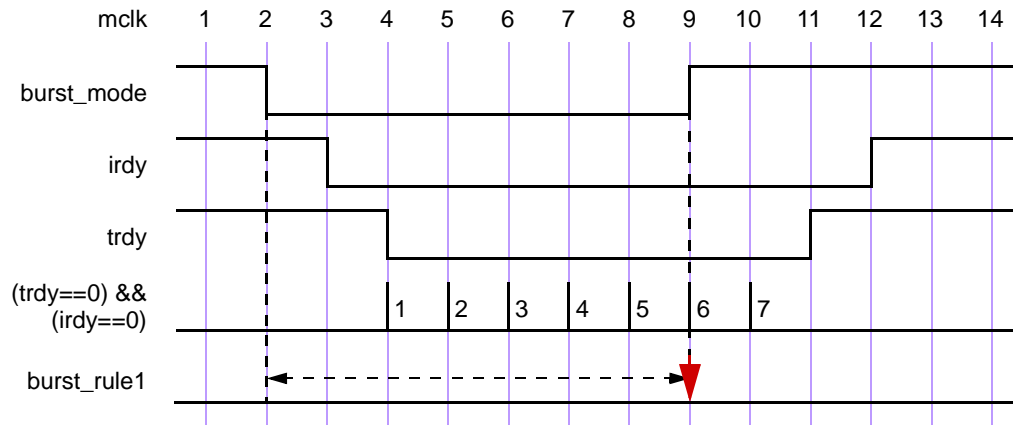

Figure 17-11 — Match with throughout restriction fails

~~In the above expression, the value of signal *burst_mode* is required to be low during the sequence (from clock tick 2 to 10) and is checked at every clock tick during that period. At clock ticks from 2 to 8, signal *burst_mode* remains low and matches the expression at those clock ticks. At clock tick 9, signal *burst_mode* becomes high, thereby failing to match the expression for *burst_rule1*.~~

~~If signal *burst_mode* were to be maintained low until at least clock tick 10, the expression would result in a match as shown in Figure 17-12.~~

LRM 177

Figure 17-12 illustrates the evaluation attempt for sequence `burst_rule1` beginning at clock tick 2. Since signal `burst_mode` is high at clock tick 1 and low at clock tick 2, `$fell(burst_mode)` is true at clock tick 2. To complete the match of `burst_rule1`, the value of `burst_mode` is required to be low throughout a match of the sub-sequence `(##2 ((trdy==0)&&(irdy==0)) [*7])` beginning at clock tick 2. This sub-sequence matches from clock tick 2 to clock tick 10. However, at clock tick 9 `burst_mode` becomes high, thereby failing to match according to the rules for `throughout`.

LRM 238

If signal `burst_mode` were instead to remain low through at least clock tick 10, then there would be a match

of `burst_rule1` from clock tick 2 to clock tick 10, as shown in Figure 17-12.

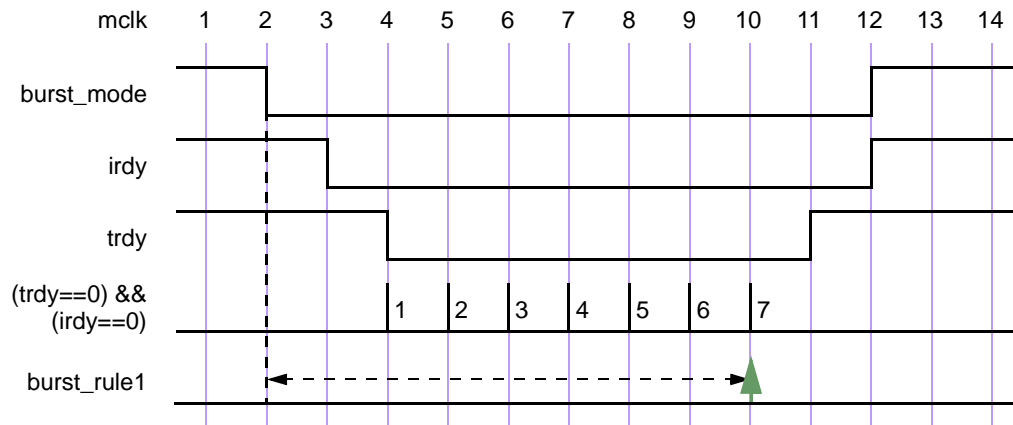

Figure 17-12 — Match with throughout restriction succeeds

17.7.9 Sequence occurrence contained within another sequence

LRM 238

The containment of a sequence `expression` within another sequence is expressed as follows:

```
sequence_expr ::= // from Annex A.2.10
    ...
    | sequence_expr within sequence_expr
```

Syntax 17-11—within construct syntax (excerpt from Annex A)

~~The within construct:~~

~~sequence_expr1 **within** sequence_expr2~~

The construct `seq1 within seq2` is an abbreviation for ~~writing~~:

LRM 238

~~(1[*0:\$] ##1 sequence_expr1 seq1 ##1 1[*0:\$]) intersect seq2 sequence_expr2~~

~~The sequence sequence_expr1 must occur at least once entirely within the sequence sequence_expr2. That is, sequence_expr1 must satisfy the following:~~

The composite sequence `seq1 within seq2` matches along a finite interval of consecutive clock ticks provided `seq2` matches along the interval and `seq1` matches along some sub-interval of consecutive clock ticks. That is, the matches of `seq1` and `seq2` must satisfy the following:

- ~~The start point of sequence_expr1 must be between the start point and the end point (start and end point being inclusive) of sequence_expr2. The start point of the match of seq1 must be no earlier than the start point of the match of seq2.~~
- ~~The end point of sequence_expr1 must be between the start point and the end point (start and end point being inclusive) of sequence_expr2. The end point of the match of seq1 must be no later than the end point of the match of seq2.~~

For example, the sequence `expression`

```
!trdy[*7] within (($fell irdy) ##1 !irdy[*8])
```

LRM 177

matches from clock tick 3 to clock tick 11 on the trace shown in Figure 17-12.

17.7.10 Detecting and using endpoint of a sequence

There are two ways in which a complex sequence can be decomposed into simpler **sub-expressions** sub-sequences.

LRM 208
LRM 238
LRM 274

~~One is to reference the name of a sequence, thereby causing it to be started at the point where it is referenced, as shown below:~~ One is to instantiate a named sequence by referencing its name. Evaluation of such a reference requires the named sequence to match starting from the clock tick at which the reference is reached during the evaluation of the enclosing sequence. For example:

```
sequence s;
  a ##1 b ##1 c;
endsequence
sequence rule;
  @(posedge sysclk)
  trans ##1 start_trans ##1 s ##1 end_trans);
endsequence
```

Sequence *s* is evaluated beginning one cycle tick after the occurrence evaluation of *start_trans* in the sequence rule.

Another way to use ~~the a~~ sequence expression is to detect its end point in another sequence. The end point of a sequence is reached whenever ~~there is a match on its expression~~ the ending clock tick of a match of the sequence is reached, regardless of the starting clock tick of the match. The occurrence reaching of the end point can be tested in any sequence expression by using the method *ended*.

The syntax of the *ended* method is:

```
sequence_identifier sequence_instance.ended
```

ended is a method on a sequence. The result of its operation is true or false. When method *ended* is applied evaluated in an expression, it tests whether its operand sequence *seq_name* has reached the its end point at that particular point in time. The result of *ended* does not depend upon the starting point of *seq_name* the match of its operand sequence. An example is shown below:

```
sequence e1;
  @(posedge sysclk) $rose(ready) ##1 proc1 ##1 proc2 ;
endsequence
sequence rule;
  @(posedge sysclk) reset ##1 inst ##1 e1.ended ##1 branch_back;
endsequence
```

~~In~~ In this example, sequence expression *e1* must end successfully match one clock tick after *inst*. If the method *ended* is replaced with an instance of sequence ~~e1~~ *e1*, a match of *e1* must start one clock tick after *inst*. Notice that method *ended* only tests for the end point of *e1*, and has no bearing on the starting point of *e1*. *ended* can be used on sequences that have formal arguments. For example with the definitions ~~declarations~~

LRM 238
LRM 262

LRM 128

```
sequence e2(a,b,c);
  @(posedge sysclk) $rose(a) ##1 b ##1 c;
endsequence
sequence rule2;
  @(posedge sysclk) reset ##1 inst ##1 e2(ready,proc1,proc2).ended
  ##1 branch_back;
endsequence
```

~~rule2~~ *rule2* is equivalent to ~~rule2a~~ *rule2a* below:

```

sequence e2_instantiated;
  e2 (ready, proc1, proc2);
endsequence
sequence rule2a;
  @(posedge sysclk) reset ##1 inst ##1 e2_instantiated.ended ##1 branch_back;
endsequence

```

There are additional restrictions on passing local variables into an instance of a sequence to which `ended` is applied. See Section 17.8.

17.7.11 Implication

The implication construct ~~allows a user to monitor properties based on satisfying some criteria. Most common uses are to attach a precondition to a sequence, where the evaluation of the sequence is based on the success of a condition.~~ specifies that the checking of a property is performed conditionally on the match of a sequential antecedent.

LRM 131

LRM 238

```

property_expr ::= // from Annex A.2.10
  ...
  | sequence_expr |-> property_expr
  | sequence_expr |=> property_expr
multi_clock_property_expr ::=
  ...
  | multi_clock_sequence |> multi_clock_property_expr
  | multi_clock_sequence |=> multi_clock_property_expr

```

LRM 131

LRM 278

Syntax 17-12—implication syntax (excerpt from Annex A)

This clause is used to precondition monitoring of a property expression and is allowed at the property level. The result of the implication is either true or false. The left-hand side operand *sequence_expr* is called the *antecedent*, while the right-hand side operand *property_expr* is called the *consequent*.

LRM 131

The following points should be noted for `| ->` implication:

- From a given start point, the ~~antecedent~~ antecedent *sequence_expr* can have zero, one, or more than one successful match.
- If there is no match of the ~~antecedent~~ antecedent *sequence_expr* from a given start point, then evaluation of the implication from that start point succeeds vacuously and returns true.
- For each successful match of ~~antecedent~~ antecedent *sequence_expr*, the ~~consequent~~ consequent *property_expr* is separately evaluated. The end point of the match of the ~~antecedent~~ antecedent *sequence_expr* is the start point of the evaluation of the ~~consequent~~ consequent *property_expr*.
- From a given start point, evaluation of the implication succeeds and returns true if and only if for every match of the ~~antecedent~~ antecedent *sequence_expr* beginning at the start point, the evaluation of the ~~consequent~~ consequent *property_expr* beginning at the endpoint of the match succeeds and returns true.

Two forms of implication are provided: overlapped using operator `| ->`, and non-overlapped using operator `| =>`. For overlapped implication, if there is a match for the ~~antecedent~~ antecedent *sequence_expr*, then the end point of the match is the start point of the evaluation of the consequent *property_expr*. For non-overlapped implication, the start point of the evaluation of the consequent *property_expr* is the clock tick after the end point of the match. Therefore:

```
sequence_expr | => property_expr
```

is equivalent to:

```
sequence_expr ##1 `true |-> property_expr
```

The use of implication when multi-clock sequences and properties are involved is explained in Section 17.12.

The following example illustrates a bus operation for data transfer from a master to a target device. When the bus enters a data transfer phase, multiple data phases can occur to transfer a block of data. During the data transfer phase, a data phase completes on any rising clock edge on which `irdy` is asserted and either `trdy` or `stop` is asserted. Note that an asserted signal here implies a value of low. The end of a data phase can be expressed as:

```
property data_end;
  @(posedge mclk)
  data_phase |-> ((irdy==0) && ($fell(trdy) || $fell(stop))) ;
endproperty
```

Each time a data phase is true, a match for `data_phase` is recognized. The attempt at clock tick 6 is illustrated in Figure 17-13. The values shown for the signals are the sampled values with respect to the clock. At clock tick 6, `data_end` is true because `stop` gets asserted while `irdy` is asserted.

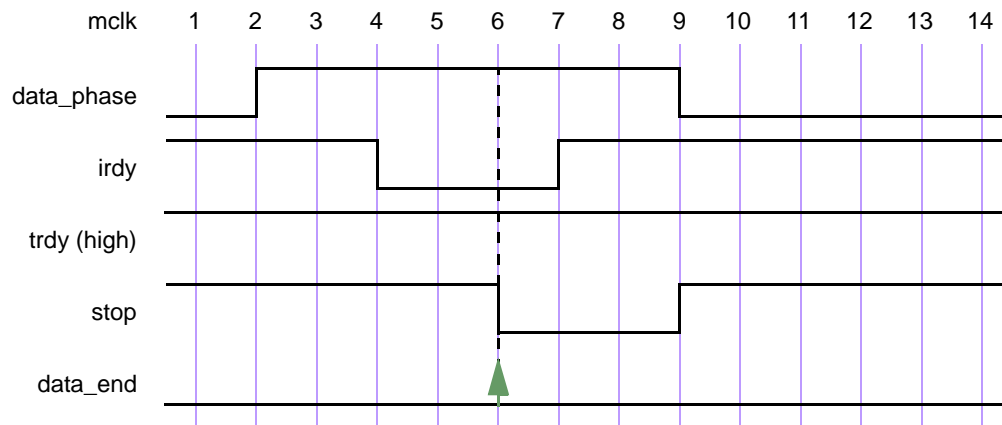

Figure 17-13 — Conditional sequence matching

In another example, `data_end_exp` is used to ensure that `frame` is de-asserted (value high) within 2 clock ticks after `data_end_exp` occurs. Further, it is also required that `irdy` is de-asserted (value high) one clock tick after `frame` is de-asserted.

A property written to express this condition is shown below.

```
`define data_end_exp (data_phase && ((irdy==0)&&($fell(trdy) || $fell(stop))))
property data_end_rule1;
  @(posedge mclk)
  `data_end_exp |-> ##[1:2] $rose(frame) ##1 $rose(irdy);
endproperty
```

property `data_end_rule1` first evaluates `data_end_exp` at every clock tick to test if its value is true. If the value is false, then that particular attempt to evaluate `data_end_rule1` is considered true. Otherwise, the following sequence **expression** is evaluated. The sequence **expression**:

```
##[1:2] $rose(frame) ##1 $rose(irdy)
```

specifies looking for the rising edge of `frame` within two clock ticks in the future. After `frame` toggles high, `irdy` must also toggle high after one clock tick. This is illustrated in Figure 17-14 for the evaluation attempt at

LRM 238

LRM 178

clock tick 6. `'data_end_exp` is acknowledged at clock tick 6. Next, `frame` toggles high at clock tick 7. Since this falls within the timing constraint imposed by `[1:2]`, it satisfies the sequence and continues to evaluate further. At clock tick 8, `irdy` is evaluated. Signal `irdy` transitions to high at clock tick 8, matching the sequence specification completely for the attempt that began at clock tick 6.

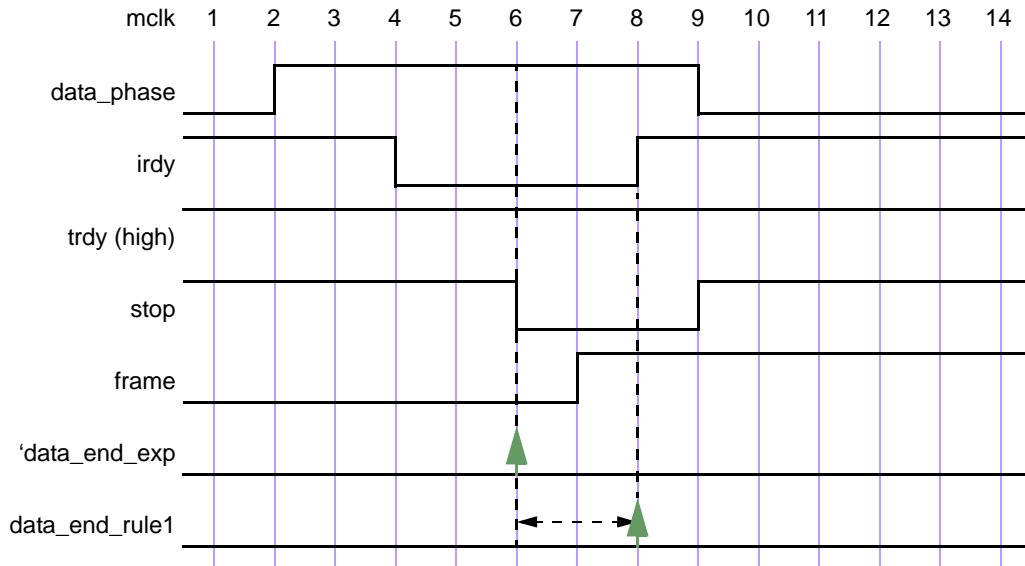

Figure 17-14 — Conditional sequences

Generally, assertions are associated with preconditions so that the checking is performed only under certain specified conditions. As seen from the previous example, the `|->` operator provides this capability to specify preconditions with sequences that must be satisfied before evaluating their consequent properties. The next example modifies the preceding example to see the effect on the results of the assertion by removing the precondition for the consequent. This is shown below, and illustrated in Figure 17-15.

LRM 131

```
property data_end_rule2;
  @(posedge mclk) ##[1:2] $rose(frame) ##1 $rose(irdy);
endproperty
```

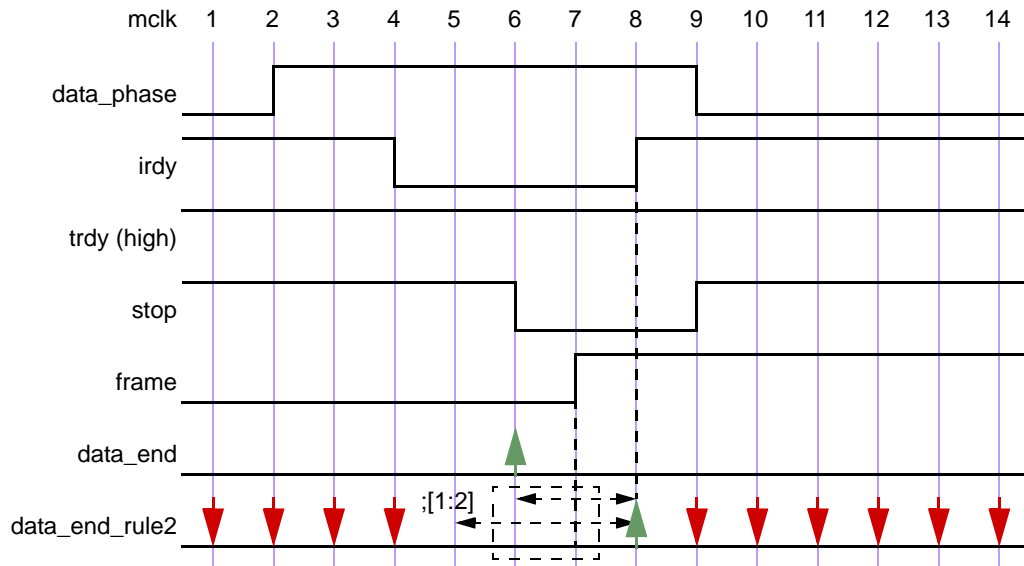

Figure 17-15 — Results without the condition

The property is evaluated at every clock tick. For the evaluation at clock tick 1, the rising edge of signal `frame` does not occur at clock tick 1 or 2, so the property fails at clock tick 1. Similarly, there is a failure at clock ticks 2, 3, and 4. For attempts starting at clock ticks 5 and 6, the rising edge of signal `frame` at clock tick 7 allows checking further. At clock tick 8, the sequences complete according to the specification, resulting in a match for attempts starting at 5 and 6. All later attempts to match the sequence fail because `$rose(frame)` does not occur again. ~~That also means that there is no match at 5, 6, and 7.~~

LRM 212

Figure 17-15 shows that removing the precondition of checking `'data_end_exp` from the assertion causes failures that are not relevant to the verification objective. It is important from the validation standpoint to determine these preconditions and use them to filter out inappropriate or extraneous situations.

An example of implication where the antecedent is a sequence ~~expression~~ follows:

LRM 238

```
(a ##1 b ##1 c) |-> (d ##1 e)
```

If the sequence `(a ##1 b ##1 c)` matches, then the sequence `(d ##1 e)` must also match. On the other hand, if the sequence `(a ##1 b ##1 c)` does not match, then the result is true.

~~In the next example, all matches of `(a ##[1:3] b ##1 c)` must match `(d ##1 e)`. If there are no matches of `(a ##[1:3] b ##1 c)`, then there is a vacuous success for the property.~~

Another example of implication is:

```
property p16;
  (write_en & data_valid) ##0
  (write_en && (retire_address[0:4]==addr)) [*2] |->
  ##[3:8] write_en && !data_valid && (write_address[0:4]==addr);
endproperty
```

This property can be coded alternatively as a nested implication:

LRM 131

```
property p16_nested;
  (write_en & data_valid) |->
  (write_en && (retire_address[0:4]==addr)) [*2] |->
  ##[3:8] write_en && !data_valid && (write_address[0:4]==addr);
endproperty
```

Multi-clock sequence implication is explained in Section 17.12.

17.8 Manipulating data in a sequence

The use of a static SystemVerilog variables implies that only one copy exists. ~~Therefore, if~~ If data values need to be checked in pipelined designs, then for each quantum of data entering the pipeline, a separate variable can be used to store the predicted output of the pipeline for later comparison when the result actually exits the pipe. This storage can be built by using an array of variables arranged in a shift register to mimic the data propagating through a the pipeline. However, in more complex situations where the latency of the pipe is variable and out of order, this construction could become very complex and error prone. ~~In other words~~ Therefore, variables are needed that are local to and are used within a particular transaction check that can span an arbitrary interval of time and can overlap with other transaction checks. Such a variable must thus be dynamically created when needed within an instance of a sequence and removed when the end of the sequence is reached.

LRM 238

The dynamic creation of a variable and its assignment is achieved by using the local variable declaration in a sequence or property ~~definition~~ declaration and making an assignment in the sequence.

```
sequence_expr ::= //from Annex A.2.10
    ...
    | ( expression_or_dist {, sequence_match_item } ) [ boolean_abbrev ]
    | ( sequence_expr {, sequence_match_item } ) [ sequence_abbrev ]
    ...
```

LRM 129

LRM 180

LRM 100

Syntax 17-13—variable assignment syntax (excerpt from Annex A)

The type of variable is explicitly specified. The variable can be assigned at the end point of any syntactic subsequence by placing the subsequence, comma separated from the sampling assignment, in parentheses. For example, if in

LRM 129

```
a ##1 b[*->1] ##1 c[*2]
```

it is desired to **sample assign** `x = e` at the match of `b b[->1]`, the sequence **expression** can be rewritten as

LRM 209
LRM 238

```
a ##1 (b[*->1], x = e) ##1 c[*2]
```

The local variable can be reassigned later in the sequence, as in

```
a ##1 (b[*->1], x = e) ##1 (c[*2], x = x + 1)
```

For every attempt, a new copy of the variable is created for the sequence. The variable value can be tested like any other SystemVerilog variable.

Hierarchical references to a local variable are not allowed.

As an example **the** of local variable usage, assume a pipeline that has a fixed latency of 5 clock cycles. The data enters the pipe on `pipe_in` when `valid_in` is true, and the value computed by the pipeline appears 5 clock cycles later on the signal `pipe_out1`. The data as transformed by the pipe is predicted by a function that increments the data. The following **sequence-expression property** verifies this behavior:

LRM 238

```
property e;
    int x;
    (valid_in, (x = pipe_in)) |-> ##5 (pipe_out1 == (x+1));
endproperty
```

Property e is evaluated as :

- 1) When `valid_in` is true, `x` is assigned **to** the value of `pipe_in`. **Property e is true if** If five cycles later, `pipe_out1` is equal to `(x+1)`, **then property e is true. Otherwise, property e is false. Property e is false if** `pipe_out1` is not equal to `(x+1)`.
- 2) When `valid_in` is `valid_in` false, property e evaluates to true.

LRM 177

Variables can be used in sequences or properties.

```
sequence data_check;
    int x;
    a ##1 !a, x = data_in ##1 !b[*0:$] ##1 b && (data_out == x);
endsequence
property data_check_p
    int x;
    a ##1 !a, x = data_in |=> !b[*0:$] ##1 b && (data_out == x);
endproperty
```

LRM 177

Local variables can be written on repeated sequences and accomplish accumulation of values.

```
sequence rep_v;
  int x;
  `true, x = 0 ##0
  (!a [* 0:$] ##1 a, x = x+data) [*4] ##1 b ##1 c && (data_out == x);
endsequence
```

The local variables declared in one sequence are not visible in the sequence where it gets instantiated. An example below illustrates an illegal access to local variable `v1` of sequence `sub_seq1` in sequence `seq1`.

```
sequence sub_seq1;
  int v1;
  a ##1 !a, v1 = data_in ##1 !b[*0:$] ##1 b && (data_out == v1);
endsequence
sequence seq1;
  c ##1 sub_seq1 ##1 (do1 == v1); // error since v1 is not visible
endsequence
```

LRM 177

To access a local variable of a sub-sequence, a local variable must be declared and passed to the instantiated sub-sequence through an argument. An example below illustrates this usage.

```
sequence sub_seq2(lv);
  a ##1 !a, lv = data_in ##1 !b[*0:$] ##1 b && (data_out == lv);
endsequence
sequence seq2;
  int v1;
  c ##1 sub_seq2(v1) ##1 (do1 == v1); // v1 is now bound to lv
endsequence
```

LRM 177

Local variables can be passed into an instance of a **defined named** sequence to which **ended** is applied and accessed in a similar manner. For example

LRM 128

LRM 238

```
sequence seq2a;
  int v1; c ##1 sub_seq2(v1).ended ##1 (do1 == v1); // v1 is now bound to lv
endsequence
```

There are additional restrictions when passing local variables into an instance of a **defined named** sequence to which **ended** is applied:

- 1) Local variables can be passed in only as entire actual arguments, not as proper subexpressions of actual arguments.
- 2) In the declaration of the **defined named** sequence, the formal argument to which the local variable is bound must not be referenced before it is **sampled assigned**.

The second restriction is met by `sub_seq2` because the **sampling assignment** `lv = data_in` occurs before the reference to `lv` in `data_out == lv`.

If a local variable is **sampled assigned** before being passed into an instance of a **defined named** sequence to which **ended** is applied, then the restrictions prevent this **sampled assigned** value from being visible within the **defined named** sequence. The restrictions are important because the use of **ended** means that there is no guaranteed relationship between the point in time at which the local variable is **sampled assigned** outside the **defined named** sequence and the beginning of the match of the instance.

A local variable that is passed in as actual argument to an instance of a **defined named** sequence to which **ended** is applied will flow out of the application of **ended** to that instance provided both of the following conditions are met:

- 1) The local variable flows out of the end of the **defined named** sequence instance, as defined by the local variable flow rules for sequences. (See below and Annex H.)

- 2) The application of `ended` to this instance is a maximal boolean expression. In other words, the application of `ended ended` cannot have negation or any other expression operator applied to it.

Both conditions are satisfied by `sub_seq2` and `seq2a`. Thus, in `seq2a` the value in ~~`v1`~~ `v1` in the comparison `do1 == v1` is the value ~~sampled into~~ assigned to `lv` in `sub_seq2` by the assignment `lv = data_in`. However, in

```
sequence seq2b;
  int v1; c ##1 !sub_seq2(v1).ended ##1 (do1 == v1); // v1 undefined
unassigned
endsequence
```

the second condition is violated because of the negation applied to `sub_seq2(v1).ended`. Therefore, `v1` does not flow out of the application of `ended ended` to this instance, and so the reference to `v1` in `do1 == v1` is to an ~~unsampled~~ `unassigned` variable.

In a single cycle, there can be multiple matches of a sequence instance to which `ended ended` is applied, and these matches can have different valuations of the local variables. The multiple matches are treated semantically the same way as matching both disjuncts of an `or` (see below). In other words, the thread evaluating the instance to which `ended ended` is applied will fork to account for such distinct local variable valuations.

Note that when a local variable is a formal argument of a sequence ~~definition~~ `declaration`, it is illegal to declare the variable, as shown below.

```
sequence sub_seq3(lv);
  int lv; // illegal since lv is a formal argument
  a ##1 !a, lv = data_in ##1 !b[*0:$] ##1 b && (data_out == lv);
endsequence
```

LRM 177

~~There are special considerations on using local variables in parallel branches using operators `or`, `and`, and `intersect`.~~

LRM 238

There are special considerations when using local variables in sequences involving the branching operators `or`, `and`, and `intersect`. The evaluation of a composite sequence constructed from one of these operators can be thought of as forking two threads to evaluate the operand sequences in parallel. A local variable may have been assigned a value before the start of the evaluation of the composite sequence. Such a local variable is said to flow in to each of the operand sequences. The local variable may be assigned or reassigned in one or both of the operand sequences. In general, there is no guarantee that evaluation of the two threads results in consistent values for the local variable, or even that there is a consistent view of whether the local variable has been assigned a value. Therefore, the values assigned to the local variable before and during the evaluation of the composite sequence are not always allowed to be visible after the evaluation of the composite sequence.

In some cases, inconsistency in the view of the local variable's value does not matter, while in others it does. Precise conditions are given in Annex H to define static (i.e., compile-time computable) conditions under which a sufficiently consistent view of the local variable's value after the evaluation of the composite sequence is guaranteed. If these conditions are satisfied, then the local variable is said to flow out of the composite sequence. An intuitive description of the conditions for local variable flow follows.

- 1) Variables assigned on parallel threads cannot be accessed in sibling threads. For example:

```
sequence s4;
  int x;
  (a ##1 b, (x = data) ##1 c) or (d ##1 (e==x)); // illegal
endsequence
```

- 2) ~~In the case of `or`, it is the intersection of the variables (names) that pass on past `or` operations. More precisely, a local variable passes the `or` if, and only if, it passes through both branches of `or` operations. In the case of `or`, a local variable flows out of the composite sequence if and only if it flows out of each of the~~

operand sequences. If the local variable is not assigned before the start of the composite sequence and it is assigned in only one of the operand sequences, then it does not flow out of the composite sequence.

- 3) ~~All succeeding threads out of or branches continue as separate threads, carrying with them their own latest samplings of the local variables.~~ Each thread for an operand of an `or` that matches its operand sequence continues as a separate thread, carrying with it its own latest assignments to the local variables that flow out of the composite sequence. These threads do not have to have consistent valuations for the local variables. For example:

```
sequence s5;
  int x,y;
  ((a ##1 b, x = data, y = data1 ##1 c)
   or (d ##1 `true, x = data ##0 (e==x))) ##1 (y==data2);
  // illegal since y is not in the intersection
endsequence
sequence s6;
  int x,y;
  ((a ##1 b, x = data, y = data1 ##1 c)
   or (d ##1 `true, x = data ##0 (e==x))) ##1 (x==data2);
  // legal since x is in the intersection
endsequence
```

- 4) ~~In the case of and and intersect, the symmetric difference of the local variables that are sampled in the two joining threads passes on past the join. More precisely, a local variable that passes through at least one branch of the join shall be passed on past the join unless it is blocked. A local variable is blocked from passing on past the join if either:~~ In the case of `and` and `intersect`, a local variable that flows out of at least one operand shall flow out of the composite sequence unless it is blocked. A local variable is blocked from flowing out of the composite sequence if either:

- a) The local variable is ~~sampled~~ assigned in and ~~passes through each branch of the join~~ flows out of each operand of the composite sequence. Or,
- b) The local variable is blocked from ~~passing through at least one of the branches of the join~~ flowing out of at least one of the operand sequences.

~~The value passed on is the latest sampled value. The two joining threads are merged into one thread at the join.~~

The value of a local variable that flows out of the composite sequence is the latest assigned value. The threads for the two operands are merged into one at completion of evaluation of the composite sequence.

```
sequence s7;
  int x,y;
  ((a ##1 b, x = data, y = data1 ##1 c)
   and (d ##1 `true, x = data ##0 (e==x))) ##1 (x==data2);
  // illegal since x is common to both threads
endsequence
sequence s8;
  int x,y;
  (a ##1 b, x = data, y = data1 ##1 c)
  and (d ##1 `true, x = data ##0 (e==x)) ##1 (y==data2);
  // legal since y is in the difference
endsequence
```

- 5) ~~The intersection and difference of the sets of names should be computed statically at compile time.~~

17.9 Calling subroutines on match of a sequence

LRM 180

Tasks, task methods, void functions, void function methods, and system tasks can be called at the end of suc-

successful match of a sequence. The subroutine calls, like local variable assignments, appear in the comma-separated list that follows the sequence. The subroutine calls are said to be *attached* to the sequence. The sequence and the list that follows are enclosed in parentheses.

```
sequence_expr ::= //from Annex A.2.10
    ...
    | ( expression_or_dist {, sequence_match_item } ) [ boolean_abbrev ]
    | ( sequence_expr {, sequence_match_item} ) [ sequence_abbrev ]
    ...
sequence_match_item ::=
    variable_assignment
    | subroutine_call
```

Syntax 17-14—subroutine call in sequence syntax (excerpt from Annex A)

For example,

```
sequence s1;
  logic v, w;
  (a, v = e) ##1
  (b[*->1], w = f, $display("b after a with v = %h, w = %h\n", v, w));
endsequence
```

LRM 209

defines a sequence `s1` that matches at the first occurrence of `b` strictly after an occurrence of `a`. At the match, the system task `$display` is executed to write a message that announces the match and shows the values assigned to the local variables `v` and `w`.

All subroutine calls attached to a sequence are executed at every successful match of the sequence. For each successful match, the attached calls are executed in the order they appear in the list. The subroutines are scheduled in the Reactive region, like an action block.

Each argument of a subroutine call attached to a sequence must either be passed by value as an input or be passed by reference (either `ref` or `const ref`; see Section 10.4.2). Actual argument expressions that are passed by value use sampled values of the underlying variables and are consistent with the variable values used to evaluate the sequence match.

Local variables can be passed into subroutine calls attached to a sequence. Any local variable that flows out of the sequence or that is assigned in the list following the sequence, but before the subroutine call, can be used in an actual argument expression for the call. If a local variable appears in an actual argument expression, then that argument must be passed by value.

17.10 System functions

Assertions are commonly used to evaluate certain specific characteristics of a design implementation, such as whether a particular signal is “one-hot”. The following system functions are included to facilitate such common assertion functionality:

- `$onehot (<expression>)` returns true if only one bit of the expression is high.
- `$onehot0 (<expression>)` returns true if at most one bit of the expression is high.
- `$isunknown (<expression>)` returns true if any bit of the expression is ~~✗~~ X or Z. This is equivalent to `^<expression> === 'bx.`

LRM 231

All of the above system functions have a return type of bit. A return value of `1'b1` indicates true, and a return

value of 1'b0 indicates false.

~~If the specified clock tick in the past is before the start of simulation, the returned value from the \$past function is a value of X.~~

Another useful function provided for the boolean expression is \$countones, to count the number of 1s in a bit vector expression.

```
$countones ( expression)
```

An x and z value of a bit is not counted towards the number of ones.

17.11 ~~The property definition~~ Declaring properties

LRM 238

A property defines a behavior of the design. A property can be used for verification as an assumption, a checker, or a coverage specification. In order to use the behavior for verification, an **assert**, **assume** or **cover** statement must be used. A property declaration by itself does not produce any result.

A property can be declared in

- a module ~~as a module_or_generate_item~~
- an interface ~~as an interface_or_generate_item~~
- a program ~~as a non_port_program_item~~
- a clocking block ~~as a clocking_item~~
- a package
- a compilation-unit scope

LRM 240

LRM 137

LRM 58

To declare a property, the **property** construct is used as shown below:

```

concurrent_assertion_item_declaration ::=                               //from Annex A.2.10
    property_declaration
    ...
property_declaration ::=
    property property_identifier [ property_formal_list ( [ list_of_formals ] ) ] ;
    { assertion_variable_declaration }
    property_spec ;
    endproperty [ : property_identifier ]
property_formal_list ::=
    ( formal_list_item { , formal_list_item } )
list_of_formals ::= formal_list_item { , formal_list_item }
property_spec ::=
    [ clocking_event ] [ disable iff ( expression ) ] property_expr
    † [ disable iff ( expression ) ] multi_clock_property_expr
property_expr ::=
    sequence_expr
    | ( property_expr )
    | not property_expr
    | property_expr or property_expr
    | property_expr and property_expr
    | sequence_expr -> property_expr
    | sequence_expr ==> property_expr
    | if ( expression ) property_expr [ else property_expr ]
    | property_instance
    | clocking_event property_expr
multi_clock_property_expr ::=
    property_expr
    † multi_clock_sequence
    † clocking_event multi_clock_property_expr
    † ( multi_clock_property_expr )
    † not multi_clock_property_expr
    † multi_clock_property_expr or multi_clock_property_expr
    † multi_clock_property_expr and multi_clock_property_expr
    † multi_clock_sequence -> multi_clock_property_expr
    † multi_clock_sequence ==> multi_clock_property_expr
    † if ( expression ) multi_clock_property_expr [ else multi_clock_property_expr ]
    † property_instance
assertion_variable_declaration ::=
    data_type list_of_variable_identifiers ;
property_instance ::=                                             | //from Annex A.6.10
    ps_property_identifier [ ( [ actual_arg_list ] ) ]

```

LRM 208
LRM 240
LRM 249
LRM 262
LRM 278

LRM 131

Syntax 17-15—property construct syntax (excerpt from Annex A)

A **property** is declared with optional formal arguments, as in a sequence declaration. When a property is instantiated, actual arguments can be passed to the property. The property gets expanded with the actual arguments by replacing the formal arguments with the actual arguments. **The semantic Semantic** checks are performed to ensure that the expanded property with the actual arguments is legal.

LRM 238

The result of property evaluation is either true or false. There are seven kinds of **properties** **property**: sequence,

negation, disjunction, conjunction, `if...else`, implication, and instantiation.

LRM 131

- 1) A property that is a sequence evaluates to true if and only if there is a **non-empty** match of the sequence. A **sequence that admits an empty match is not allowed as a property**. Since there is a match if and only if there is a first match, evaluation of such a property is the same as implicitly transforming its `sequence_expr` to `first_match(sequence_expr)`. As soon as a match of `sequence_expr` is determined, the evaluation of the property is considered to be true, and no other matches are required for that evaluation attempt.

LRM 280

- 2) A property is a negation if it has the form

```
not property_expr
```

For each evaluation attempt of the property, there is an evaluation attempt of `property_expr`. The keyword `not` states that the evaluation of the property returns the opposite of the evaluation of the underlying `property_expr`. Thus, if `property_expr` evaluates to true, then `not not property_expr` evaluates to false, and if `property_expr` evaluates to false, then `not property_expr` evaluates to true.

LRM 238

- 3) A property is a disjunction if it has the form

```
property_expr1 or property_expr2
```

The property evaluates to true if and only if at least one of `property_expr1` and `property_expr2` evaluates to true.

- 4) A property is a conjunction if it has the form

```
property_expr1 and property_expr2
```

The property evaluates to true if and only if both `property_expr1` and `property_expr2` evaluate to true.

- 5) A property is an `if...else` if it has either the form

```
if (expression) property_expr1
```

or the form

```
if (expression) property_expr1 else property_expr2
```

A property of the first form evaluates to true if and only if either `expression` evaluates to false or `property_expr1` evaluates to true. A property of the second form evaluates to true if and only if either `expression` evaluates to true and `property_expr1` evaluates to true or `expression` evaluates to false and `property_expr2` evaluates to true.

- 6) A property is an implication if it has either the form

```
sequence_expr |-> property_expr
```

or the form

```
sequence_expr |=> property_expr
```

The meaning of implications has already been discussed in 17.7.11.

- 7) An instance of a **defined named** property can be used as a `property_expr` or `property_spec`. In general, the instance is legal provided the body `property_spec` of the **defined named** property can be substituted in place of the instance, with actual arguments substituted for formal arguments, and result in a legal `property_expr` or `property_spec`, ignoring local variable declarations. Thus, for example, if an instance of a **defined named** property is used as a `property_expr` operand for any property-building operator, then the **defined named** property must not have a `disable iff` clause. Similarly, clock events in a **defined named** property must conform to the rules of multiple clock support when the property is instantiated in a `property_expr` or `property_spec` that also involves other clock events.

LRM 238

The following table lists the property operators from highest to lowest precedence and shows the associativity of the non-unary operators.

Table 17-2: Property operator precedence and associativity

SystemVerilog property operators	Associativity
not	----
and	left
or	left
if...else	right
 -> =>	right

A **disable iff** clause can be attached to a *property_expr* to yield a *property_spec*

```
disable iff (expression) property_expr
```

The expression of the **disable iff** is called the reset expression. The **disable iff** clause allows asynchronous resets to be specified. For an evaluation of the *property_spec*, there is an evaluation of the underlying *property_expr*. If **during prior to the completion** of that evaluation the reset expression becomes true, then the overall evaluation of the *property_spec* is true. Otherwise, the evaluation of the *property_spec* is the same as that of the *property_expr*. The reset expression is tested independently for different evaluation attempts of the *property_spec*. Nesting of **disable iff** clauses, explicitly or through property instantiations, is not allowed.

LRM 238

This allows for the following examples:

```
property rule1;
  @(posedge clk) a |-> b ##1 c ##1 d;
endproperty
property rule2;
  @(clkv) disable iff (foo) not a |-> not(b ##1 c ##1 d);
endproperty
```

Property rule2 negates the **result of the implication (a |-> b ##1 c ##1 d) for every attempt** sequence (b ##1 c ##1 d) in the consequent of the implication. *clkv* specifies the clock for the property.

```
property rule3;
  @(posedge clk) a[*2] |-> ((##[1:3] c) or (d |> e));
endproperty
```

Property rule3 says that if *a* holds and *a* also held last cycle, then either *c* must hold at some point 1 to three cycles after the current cycle, or, if *d* holds in the current cycle, then *e* must hold one cycle later.

```
property rule4;
  @(posedge clk) a[*2] |-> ((##[1:3] c) and (d |> e));
endproperty
```

Property rule4 says that if *a* holds and *a* also held last cycle, then *c* must hold at some point 1 to three cycles after the current cycle, and if *d* holds in the current cycle, then *e* must hold one cycle later.

```
property rule5;
  @(posedge clk)
  a ##1 (b || c) [*->1] |->
```

LRM 209

```

    if (b)
      (##1 d |-> e)
    else // c
      f ;
  endproperty

```

Property rule5 has a followed by the first match of either b or c as its antecedent. The consequent uses **if...else** to split cases on which of b or c is matched first.

```

  property rule6(x,y) ;
    ##1 x |-> y;
  endproperty
  property rule5a;
    @(posedge clk)
    a ##1 (b || c) [*->1] |->
      if (b)
        rule6(d,e)
      else // c
        f ;
  endproperty

```

LRM 209

Property rule5a is equivalent to rule5, but it uses an instance of rule6 as a property expression.

A property can optionally specify an event control for the clock. The clock derivation and resolution rules are described in Section 17.14.

A **named** property can be **referenced by instantiated by referencing** its name. A hierarchical name can be used, consistent with the SystemVerilog naming conventions. Like sequence declarations, variables used within a property that are not formal arguments to the property are resolved hierarchically from the scope in which the property is declared.

LRM 238

Properties that use more than one clock are described in Section 17.12

17.11.1 Recursive properties

LRM 130

SystemVerilog allows recursive **property definitions properties**. A **defined named** property is recursive if its declaration involves an instantiation of itself. Recursion provides a flexible framework for coding properties to serve as ongoing assumptions, checkers, or coverage monitors.

LRM 238

For example,

```

  property prop_always(p) ;
    p and (1'b1 |=> prop_always(p)) ;
  endproperty

```

is a recursive property that says that the formal argument property p must hold at every cycle. This example is useful if the ongoing requirement that property p hold applies after a complicated triggering condition encoded in sequence s:

```

  property p1(s,p) ;
    s |=> prop_always(p) ;
  endproperty

```

As another example, the recursive property

```

  property prop_weak_until(p,q) ;
    q or (p and (1'b1 |=> prop_weak_until(p,q))) ;
  endproperty

```

says that formal argument property p must hold at every cycle up to but not including the first cycle at which formal argument property q holds. Formal argument property q is not required ever to hold, though. This example is useful if p must hold at every cycle after a complicated triggering condition encoded in sequence s , but the requirement on p is lifted by q :

```
property p2(s,p,q);
  s | => prop_weak_until(p,q);
endproperty
```

More generally, several [property definitions](#) [properties](#) can be mutually recursive. For example

LRM 238

```
property check_phase1;
  s1 | -> (phase1_prop and (1'b1 | => check_phase2));
endproperty
property check_phase2;
  s2 | -> (phase2_prop and (1'b1 | => check_phase1));
endproperty
```

There are three restrictions on recursive property [definitions](#) [declarations](#).

RESTRICTION 1: The negation operator **not not** cannot be applied to any property expression that instantiates a recursive property. In particular, the negation of a recursive property cannot be asserted or used in defining another property.

Here are examples of illegal property [definitions](#) [declarations](#) that violate Restriction 1:

```
property illegal_recursion_1(p);
  not prop_always(not p);
endproperty

property illegal_recursion_2(p);
  p and (1'b1 | => not illegal_recursion_2(p));
endproperty
```

RESTRICTION 2: The operator **disable iff** cannot be used in the [definition declaration](#) of a recursive property. This restriction is consistent with the restriction that **disable iff** cannot be nested.

Here is an example of an illegal property [definition declaration](#) that violates Restriction 2:

```
property illegal_recursion_3(p);
  disable iff (b)
  p and (1'b1 | => illegal_recursion_3(p));
endproperty
```

The intent of `illegal_recursion_3` can be written legally as

```
property legal_3(p);
  disable iff (b) prop_always(p);
endproperty
```

since `legal_3` is not a recursive property.

RESTRICTION 3: If p is a recursive property, then, in the [definition declaration](#) of p , every instance of p must occur after a positive advance in time. In the case of mutually recursive properties, all recursive instances must occur after positive advances in time.

Here is an example of an illegal property [definition declaration](#) that violates Restriction 3:

```
property illegal_recursion_4(p);
  p and (1'b1 | -> illegal_recursion_4(p));
```

endproperty

If this form were legal, the recursion would be stuck in time, checking `p` over and over again at the same cycle.

Recursive properties can ~~deal with~~ represent complicated requirements, such as those associated with varying numbers of data beats, out-of-order completions, retries, etc. Here is an example of using a recursive property to check complicated conditions of this kind.

LRM 238

EXAMPLE: Suppose that write data must be checked according to the following conditions:

- Acknowledgment of a write request is indicated by the signal `write_request` together with `write_request_ack`. When a write request is acknowledged, it gets a 4-bit tag, indicated by signal `write_request_ack_tag`. The tag is used to distinguish data beats for multiple write transactions in flight at the same time.
- It is understood that distinct write transactions in flight at the same time must be given distinct tags. For simplicity, this condition is not a part of what is checked in this example.
- Each write transaction can have between 1 and 16 data beats, and each data beat is 8 bits. There is a model of the expected write data that is available at acknowledgment of a write request. The model is a ~~128-bit~~ 128-bit vector. The most significant group of 8 bits represents the expected data for the first beat, the next group of 8 bits represents the expected data for the second beat (if there is a second beat), and so forth.
- Data transfer for a write transaction occurs after acknowledgment of the write request and, barring retry, ends with the last data beat. The data beats for a single write transaction occur in order.
- A data beat is indicated by the `data_valid` signal together with the signal `data_valid_tag` to determine the relevant write transaction. The signal `data` is valid with `data_valid` and carries the data for that beat. The data for each beat must be correct according to the model of the expected write data.
- The last data ~~valid~~ beat is indicated by signal `last_data_valid` together with `data_valid` and `data_valid_tag`. For simplicity, this example does not represent the number of data beats and does not check that `last_data_valid` is signaled at the correct beat.
- At any time after acknowledgement of the write request, but not later than the cycle after the last data ~~valid~~ beat, a write transaction can be forced to retry. Retry is indicated by the signal ~~retry~~ `retry` together with signal `retry_tag` to identify the relevant write transaction. If a write transaction is forced to retry, then its current data transfer is aborted and the entire data transfer must be repeated. The transaction does not ~~rerequest~~ re-request and its tag does not change.
- There is no limit on the number of times a write transaction can be forced to retry.
- A write transaction completes the cycle after the last data ~~valid~~ beat provided it is not forced to retry in that cycle.

Here is code to check these conditions:

```
property check_write;

    logic [0:127] expected_data; // local variable to sample model data
    logic [3:0] tag; // local variable to sample tag

    disable iff (reset)
    (
        write_request && write_request_ack,
        expected_data = model_data,
        tag = write_request_ack_tag
    )
    | =>
    check_write_data_beat(expected_data, tag, 4'h0);
```

```

endproperty

property check_write_data_beat
(
    expected_data, // [0:127]
    tag,           // [3:0]
    i              // [3:0]
);

    first_match
    (
        ##[0:$]
        (
            (data_valid && (data_valid_tag == tag))
            ||
            (retry && (retry_tag == tag))
        )
    )
    |->
    (
        (
            (data_valid && (data_valid_tag == tag))
            |->
            (data == expected_data[i*8+:8])
        )
        and
        (
            if (retry && (retry_tag == tag))
            (
                1'b1 |> check_write_data_beat(tag, expected_data, 4'h0)
            )
            else if (!last_data_valid)
            (
                1'b1 |> check_write_data_beat(tag, expected_data, i+4'h1)
            )
            else
            (
                ##1 (retry && (retry_tag == tag))
                |>
                check_write_data_beat(tag, expected_data, 4'h0)
            )
        )
    )
);

endproperty

```

17.12 Multiple clock support

Multiple clock sequences and properties can be specified using the following syntax.

```

sequence_spec ::= multi_clock_sequence sequence_expr //from Annex A.2.10
                multi_clock_sequence ::=
                sequence_expr
                clocking_event multi_clock_sequence
                (multi_clock_sequence)
                multi_clock_sequence ## multi_clock_sequence
                multi_clock_sequence cycle_delay_range multi_clock_sequence
multi_clock_property_expr ::=
    property_expr
    | multi_clock_sequence
    | clocking_event multi_clock_property_expr
    | (multi_clock_property_expr)
    | not multi_clock_property_expr
    | multi_clock_property_expr or multi_clock_property_expr
    | multi_clock_property_expr and multi_clock_property_expr
    | multi_clock_sequence |> multi_clock_property_expr
    | multi_clock_sequence |=> multi_clock_property_expr
    | if (expression) multi_clock_property_expr [ else multi_clock_property_expr ]
    | property_instance

```

LRM 278

LRM 211
LRM 262

LRM 131

Syntax 17-16—Multiple clock syntax (excerpt from Annex A)

17.12.1 Multiply-clocked sequences

LRM 131

Multiply-clocked sequences are built by concatenating singly-clocked subsequences using the ~~multi-clock single-delay~~ concatenation operator ~~## ##1~~. This operator is non-overlapping and synchronizes between ~~the ending clock tick of the left hand sequence and the strictly subsequent starting clock tick of the right hand sequence~~ the clocks of the two sequences. The single delay indicated by ~~##1~~ is understood to be from the end-point of the first sequence, which occurs at a tick of the first clock, to the nearest strictly subsequent tick of the second clock, where the second sequence begins.

LRM 211
LRM 238

For example, consider

```
@(posedge clk0) sig0 ## ##1 @(posedge clk1) sig1
```

A match of this sequence starts with a match of sig0 at posedge clk0. Then ~~## ##1~~ moves the time to the nearest strictly subsequent posedge clk1, and the match of the sequence ends at that point with a match of sig1. If clk0 and clk1 are not identical, then the clocking event for the sequence changes after ~~## ##1~~. If clk0 and clk1 are identical, then the clocking event does not change after ~~## ##1~~ and the above sequence is equivalent to ~~the singly-clocked sequence~~

```
@(posedge clk0) sig0 ##1 sig1
```

~~When using the multi-clock concatenation operator ##, both operands~~ When concatenating differently-clocked sequences, the maximal singly-clocked subsequences are required to admit only non-empty matches. Thus, if s1, s2 are sequence expressions with no clocking events, then the multiply-clocked sequence

```
@(posedge clk1) s1 ## ##1 @(posedge clk2) s2
```

is legal only if neither s1 nor s2 can match the empty word. The clocking event ~~posedge clk1~~ posedge clk1 applies throughout the match of s1, while the clocking event posedge clk2 applies throughout the match of s2. Since the match of s1 is non-empty, there is an end point of this match at posedge clk1. The ~~## ##1~~ synchronizes between this end point and the first occurrence of posedge clk2 strictly after it. That occurrence of

posedge clk2 is the start point of the match of s2.

~~The restriction to operands that do not match the empty word when using ##~~ The restriction that maximal singly-clocked subsequences not match the empty word ensures that any multiply-clocked sequence has well-defined starting and ending clocking events and well-defined clock changes. If clk1 and clk2 are not identical, then the following sequence

```
@(posedge clk0) sig0 ## ##1 @(posedge clk1) sig1[*0:1]
```

is illegal because of the possibility of an empty match of sig1[*0:1], which would make ambiguous whether the ending clocking event is posedge clk0 or posedge clk1.

Differently-clocked or multiply-clocked sequence operands cannot be combined with any sequence operators other than ~~the multi-clock concatenation operator ## ##1~~. For example, if clk1 and clk2 are not identical, then the following ~~is~~ are illegal:

```
-(@(posedge clk1) x ##1 y) intersect -(@(posedge clk2) z[*1:$])  
@(posedge clk1) s1 ##0 @(posedge clk2) s2
```

```
@(posedge clk1) s1 ##2 @(posedge clk2) s2
```

```
@(posedge clk1) s1 intersect @(posedge clk2) s2
```

17.12.2 Multiply-clocked properties

LRM 131

As in the case of singly-clocked properties, the result of evaluating a multiply-clocked property is either true or false. Multiply-clocked properties can be formed in a number of ways.

Multiply-clocked sequences are themselves multiply-clocked properties. For example,

```
@(posedge clk0) sig0 ## ##1 @(posedge clk1) sig1
```

LRM 211

is a multiply-clocked property. If a multiply-clocked sequence is evaluated as a property starting at some point, the evaluation returns true if and only if there is a match of the multiply-clocked sequence beginning at that point.

The boolean property operators (**not**, **and**, **or**) can be used freely to combine singly- and multiply-clocked properties. The meanings of the boolean property operators are the usual ones, just as in the case of singly-clocked properties. For example,

```
(@(posedge clk0) sig0) and @(posedge clk1) sig1
```

is a multiply-clocked property, but it is not a multiply-clocked sequence. This property evaluates to true at a point if and only if the two sequences

```
@(posedge clk0) sig0
```

and

```
@(posedge clk1) sig1
```

both have matches beginning at the point.

The non-overlapping implication operator $|\Rightarrow$ can be used freely to create a multiply-clocked property from an antecedent sequence and a consequent property that are differently- or multiply-clocked. The meaning of multiply-clocked non-overlapping implication is similar to that of singly-clocked non-overlapping implication. For example, if s0, s1 are sequences ~~expressions~~ with no clocking event, then in

```
@(posedge clk0) s0  $|\Rightarrow$  @(posedge clk1) s1
```

LRM 238

`|=>` synchronizes between `posedge clk0` and `posedge clk1`. Starting at the point at which the implication is being evaluated, for each match of `s0` clocked by `clk0`, time is advanced from the end point of the match to the nearest strictly future occurrence of `posedge clk1`, and from that point there must exist a match of `s1` clocked by `clk1`.

The non-overlapping implication operator `|=>` can synchronize between the ending clock event of its antecedent and several leading clock events for subproperties of its consequent. For example, in

```
@(posedge clk0) s0 |=> @(posedge clk1) s1 and @(posedge clk2) s2
```

`|=>` synchronizes between `posedge clk0` and both `posedge clk1` and `posedge clk2`.

Since synchronization between distinct clocks always requires strict advance of time, the two property building operators that require special care with multiple clocks are the overlapping implication `|->` and `if...else`.

Since `|->` overlaps the end of its antecedent with the beginning of its consequent, the clock for the end of the antecedent must be the same as the clock for the beginning of the consequent. For example, if `clk0` and `clk1` are not identical and `s0`, `s1`, `s2` are sequences **expressions** with no clocking events, then

```
@(posedge clk0) s0 |-> @(posedge clk1) s1 ## #1 @(posedge clk2) s2
```

LRM 211
LRM 238

is illegal, but

```
@(posedge clk0) s0 |-> @(posedge clk0) s1 ## #1 @(posedge clk2) s2
```

is legal.

The `if/if...else` operators overlap the test of the boolean condition with the beginning of the `if` clause property and, if present, the `else` clause property. Therefore, whenever using `if` or `if...else`, the `if` and `else` clause properties must begin on the same clock as the test of the boolean condition. For example, if `clk0` and `clk1` are not identical and `s0`, `s1`, `s2` are sequences **expressions** with no clocking events, then

LRM 152

```
@(posedge clk0) if (b) @(posedge clk0) s1
```

LRM 238

is legal, but

```
@(posedge clk0) if (b) @(posedge clk0) s1 else @(posedge clk1) s2
```

is illegal because the `else` clause property begins on a different clock than the `if` condition.

17.12.3 Clock flow

LRM 131

Throughout this subsection, *c*, *d* denote clocking event expressions and *v*, *w*, *x*, *y*, *z* denote sequences **expressions** with no clocking events.

LRM 188

LRM 238

Clock flow allows the scope of a clocking event to extend in a natural way through various parts of multiply-clocked sequences and properties and reduces the number of places at which the same clocking event must be specified.

Intuitively, clock flow provides that in a multiply-clocked sequence or property the scope of a clocking event flows left-to-right across linear operators (e.g., repetition, concatenation, negation, implication) and distributes to the operands of branching operators (e.g., conjunction, disjunction, intersection, `if...else`) until it is replaced by a new clocking event.

For example,

```
@(c) x |=> @(c) y ##1 @(d) z
```

LRM 211
LRM 238

can be written more simply as

```
@(c) x | => y ##1 @(d) z
```

because clock c is understood to flow across $|=>$.

Clock flow eliminates the need to write clocking events in positions where the clock is not allowed to change. For example,

```
@(c) x | -> @(c) y ##1 @(d) z
```

can be written as

```
@(c) x | -> y ##1 @(d) z
```

to reinforce the restriction that the clock not change across $|->$. Similarly,

```
@(c) if (b) @(c) w ##1 @(d) x else @(c) y ##1 @(d) z
```

can be written as

```
@(c) if (b) w ##1 @(d) x else y ##1 @(d) z
```

to reinforce the restriction that the clock not change from the boolean condition b to the beginnings of the **if** and **else** clause properties.

LRM 152

Clock flow also makes the adjointness relationships between concatenation and implication clean for multiply-clocked properties:

```
@(c) x ##1 y | => @(d) z
```

LRM 188

is equivalent to

```
@(c) x | => y | => @(d) z
```

and

```
@(c) x ##0 y | => @(d) z
```

is equivalent to

```
@(c) x | -> y | => @(d) z
```

The scope of a clocking event flows into parenthesized subexpressions and, if the subexpression is a sequence, also flows left-to-right across the parenthesized subexpression. However, the scope of a clocking event does not flow out of enclosing parentheses.

For example, in

```
@(c) w ##1 (x ##1 @(d) y) | => z
```

LRM 211
LRM 238

w , x , z are clocked at c and y is clocked at d . Clock c flows across **##1**, across the parenthesized sub-sequence $(x ##1 @(d) y)$, and across $|=>$. Clock c also flows into the parenthesized sub-sequence, but it does not flow through $@(d)$. Clock d does not flow out of its enclosing parentheses.

As another example, in

```
@(c) v | => (w ##1 @(d) x) and (y ##1 z)
```

v , w , y , z are clocked at c and x is clocked at d . Clock c flows across $|=>$, distributes to both operands of the **and** (which is a property conjunction due to the multiple clocking), and flows into each of the parenthesized subex-

pressions. Within $(w \##1 @(d) x)$, c flows across $\##1$ but does not flow through $@(d)$. Clock d does not flow out of its enclosing parentheses. Within $(y \##1 z)$, c flows across $\##1$.

Similarly, the scope of a clocking event flows into an instance of a **defined named** sequence or property, and, if the instance is a sequence, also flows left-to-right across the instance. However, a clocking event in the **definition declaration** of a sequence or property does not flow out of an instance of that sequence or property.

Note that juxtaposing two clocking events nullifies the first of them:

```
@(d) @(c) x
```

is equivalent to

```
@(c) x
```

because the flow of clock d is immediately overridden by clock c .

17.12.4 Examples

LRM 131

The following are examples of multiple-clock specifications:

```
sequence s1;
  @(posedge clk1) a ##1 b; // single clock sequence
endsequence
sequence s2;
  @(posedge clk2) c ##1 d; // single clock sequence
endsequence
```

1) multiple-clock sequence

```
sequence mult_s;
  @(posedge clk) a ##1 @(posedge clk1) s1 ##1 @(posedge clk2) s2;
endsequence
```

LRM 238

2) property with a multiple-clock sequence

```
property mult_p1;
  @(posedge clk) a ##1 @(posedge clk1) s1 ##1 @(posedge clk2) s2;
endproperty
```

3) property with a named multiple-clock sequence

```
property mult_p2;
  mult_s;
endproperty
```

4) property with multiple-clock implication

```
property mult_p3;
  @(posedge clk) a ##1 @(posedge clk1) s1 | => @(posedge clk2) s2;
endproperty
```

5) property with named sequences at different clocks. In this case, if $s1$ contains a clock, then it must be identical to $(posedge clk1)$. Similarly, if $s2$ contains a clock, it must be identical to $(posedge clk2)$.

```
property mult_p5;
  @(posedge clk1) s1 | => @(posedge clk2) s2;
endproperty
```

6) property with implication, where antecedent and consequent are named multi-clocked sequences

```
property mult_p6;
```

```

    mult_s | => mult_s;
endproperty

```

- 7) property using clock flow and overlapped implication:

LRM 131

```

property mult_p7;
  @(posedge clk) a ##1 b |-> c ##1 @(posedge clk1) d;
endproperty

```

LRM 238

Here, a, b, and c are clocked at posedge clk.

- 8) property using clock flow and if...else:

```

property mult_p8;
  @(posedge clk) a ##1 b |->
    if (c)
      (1 | => @(posedge clk1) d)
    else
      e ##1 @(posedge clk2) f ;
endproperty

```

Here, a, b, c, and e are clocked at posedge clk.

17.12.5 Detecting and using endpoint of a sequence in multi-clock context

LRM 177

To detect the end point of a sequence when the clock of the source sequence is different than the destination sequence, method `matched` on the source sequence is used. The end point of a sequence is reached whenever there is a match on its expression. The occurrence of the end point can be tested in any sequence expression by using the method `ended` when the clocks of the source and destination sequences are the same, while method `matched` is used when the clocks are different.

The syntax of the `matched` method is:

```

sequence_identifier sequence_instance.matched

```

LRM 275

`matched` is a method on a sequence which return true or false. Unlike `ended`, `matched` uses synchronization between the two clocks, by storing the result of the source sequence match until the arrival of the first destination clock tick after the match. When method `matched` is applied, it tests whether the source sequence has reached the end point at that particular point in time. The result of `matched` does not depend upon the starting point of the source sequence.

Like `ended`, `matched` can be used on sequences that have formal arguments.

LRM 128

An example is shown below:

```

sequence e1(a,b,c);
  @(posedge clk) $rose(a) ##1 b ##1 c ;
endsequence
sequence e2;
  @(posedge sysclk) reset ##1 inst ##1 e1(ready,proc1,proc2).matched [*->1]
  ##1 branch_back;
endsequence

```

LRM 128

LRM 209

In this example, source sequence `e1` is evaluated at clock `clk`, while the destination sequence `e2` is evaluated at clock `sysclk`. In `e2`, the end point of the instance `e1(ready,proc1,proc2)` is tested to occur sometime after the occurrence of `inst`. Notice that method `matched` only tests for the end point of `e1(ready,proc1,proc2)` and has no bearing on the starting point of `e1(ready,proc1,proc2)`.

Local variables can be passed into an instance of a **defined named** sequence to which `matched` is applied. The same restrictions apply as in the case of `ended`. Values of local variables sampled in an instance of a **defined named** sequence to which `matched` is applied will flow out under the same conditions as for `ended`. See

LRM 238

Section 17.8.

As with ended, a sequence instance to which matched is applied can have multiple matches in a single cycle of the destination sequence clock. The multiple matches are treated semantically the same way as matching both disjuncts of an `or`. In other words, the thread evaluating the destination sequence will fork to account for such distinct local variable valuations.

17.13 Concurrent assertions

A property on its own is never evaluated for checking an expression. It must be used within a verification statement for this to occur. A verification statement states the verification function to be performed on the property. The statement can be one of the following:

- **assert** to specify the property as a checker to ensure that the property holds for the design
- **assume** to specify the property as an assumption for the environment
- **cover** to monitor the property evaluation for coverage

LRM 133

A concurrent assertion statement can be specified in:

- an always block or initial block as a statement, wherever these blocks can appear
- a module *as a module_or_generate_item*
- an interface *as an interface_or_generate_item*
- a program *as a non_port_program_item*

LRM 240

```

procedural_assertion_item ::= //from Annex A.6.10
    assert_property_statement
    † cover_property_statement
    † immediate_assert_statement
    † assume_property_statement
procedural_assertion_statement ::= //from Annex A.6.10
    concurrent_assertion_statement
    | immediate_assert_statement
concurrent_assertion_item ::= //from Annex A.2.10
    [ block_identifier : ] concurrent_assertion_statement
    concurrent_assert_statement
    † concurrent_cover_statement
    † concurrent_assertion_item_declaration
concurrent_assertion_statement ::=
    assert_property_statement
    | assume_property_statement
    | cover_property_statement
concurrent_assert_statement ::=
    {block_identifier;} assert_property_statement
concurrent_cover_statement ::=
    {block_identifier;} cover_property_statement
assert_property_statement ::=
    assert property ( property_spec ) action_block
assume_property_statement ::=
    assume property ( property_spec ) ;
cover_property_statement ::=
    cover property ( property_spec ) statement_or_null

```

LRM 240

LRM 133

Syntax 17-16—Concurrent assert construct syntax (excerpt from Annex A)

The **assert**, **assume** or **cover** statements can be referenced by their optional name. A hierarchical name can be used consistent with the SystemVerilog naming conventions. When a name is not provided, a tool shall assign a name to the statement for the purpose of reporting. Assertion control **system** tasks are described in Section 23.9.

LRM 133

LRM 240

17.13.1 assert statement

The **assert** statement is used to enforce a **property** as a checker. When the property for the **assert** statement is evaluated to be true, the pass statements of the action block are executed. Otherwise, the fail statements of the *action_block* are executed. For example,

```

property abc(a,b,c) ;
    disable iff (a==2) not @clk (b ##1 c) ;
endproperty
env_prop: assert property (abc(rst,in1,in2)) pass_stat else fail_stat ;

```

When no action is needed, a null statement (i.e. ;) is specified. If no statement is specified for **else**, then \$error is used as the statement when the assertion fails.

The *action_block* shall not include any concurrent **assert**, **assume**, or **cover** statement. The *action_block*, however, can contain immediate assertion statements.

Note: The pass and fail statements are executed in the Reactive region. The regions of execution are explained in the scheduling semantics section, Section 14.

17.13.2 assume statement

LRM 133

The purpose of the **assume** statement is to allow properties to be considered as assumptions for formal analysis as well as for dynamic simulation tools. When a property is assumed, the tools constrain the environment so that the property holds.

For formal analysis, there is no obligation to verify that the assumed properties hold. An assumed property can be considered as a hypothesis to prove the asserted properties.

For simulation, the environment must be constrained such that the properties that are assumed shall hold. Like an assert property, an assumed property must be checked and reported if it fails to hold. There is no requirement on the tools to report successes of the assumed properties.

Additionally, for random simulation, biasing on the inputs provides a way to make random choices. An expression can be associated with biasing as shown below

```
expression dist { dist_list } ; // from Annex A.1.9
```

~~The operator *dist* and the production *dist_list* is explained in Section 12.4.4. Distribution sets and the *dist* operator are explained in Section 12.4.4.~~

LRM 240

The biasing feature is only useful when properties are considered as assumptions to drive random simulation. When a property with biasing is used in an assertion or coverage, the *dist* operator is equivalent to *inside* operator, and the weight specification is ignored. For example,

```
a1:assume property @(posedge clk) req dist dist {0:=40, 1:=60} ;
property proto
  @(posedge clk) req |-> req[*1:$] ##0 ack;
endproperty
```

This is equivalent to:

```
a1_assertion:assert property req inside {0, 1} ;
property proto_assertion
  @(posedge clk) req |-> req[*1:$] ##0 ack;
endproperty
```

In the above example, signal *req* is specified with distribution in assumption *a1*, and is converted to an equivalent assertion *a1_assertion*.

It should be noted that the properties that are assumed must hold in the same way with or without biasing. When using an assume statement for random simulation, the biasing simply provides a means to select values of free variables, according to the specified weights, when there is a choice of selection at a particular time.

Consider an example specifying a simple synchronous request - acknowledge protocol, where variable *req* can be raised at any time and must stay asserted until *ack* is asserted. In the next clock cycle both *req* and *ack* must be de-asserted.

Properties governing *req* are:

```
property pr1;
  @(posedge clk) !reset_n |-> !req; //when reset_n is asserted (0),keep req 0
endproperty
property pr2;
  @(posedge clk) ack |=> !req; // one cycle after ack, req must be de-asserted
endproperty
```

```

property pr3;
    @(posedge clk) req |-> req[*1:$] ##0 ack; // hold req asserted until
                                           // and including ack asserted
endproperty

```

Properties governing ack are:

```

property pa1;
    @(posedge clk) !reset_n || !req |-> !ack;
endproperty
property pa2;
    @(posedge clk) ack |=> !ack;
endproperty

```

When verifying the behavior of a protocol controller which has to respond to requests on req, assertions `assert_req1` and `assert_req2` should be proven while assuming that statements `a1`, `assume_ack1`, `assume_ack2` and `assume_ack3` hold at all times.

```

a1:assume property @(posedge clk) req dist {0:=40, 1:=60} ;
assume_ack1:assume property (pr1);
assume_ack2:assume property (pr2);
assume_ack3:assume property (pr3);

assert_req1:assert property (pa1)
    else $display("\n ack asserted while req is still de-asserted");
assert_req2:assert property (pa2)
    else $display("\n ack is extended over more than one cycle");

```

Note that **assume** does not provide an action block, as the actions for an assumption serve no purpose.

17.13.3 cover statement

LRM 133

To monitor sequences and other behavioral aspects of the design for coverage, the same syntax is used with the **cover** statement. The tools can gather information about the evaluation and report the results at the end of simulation. When the property for the **cover** statement is successful, the pass statements can specify a coverage function, such as monitoring all paths for a sequence. The pass statement shall not include any concurrent **assert**, **assume** or **cover** statement.

Coverage results are divided into two: coverage for properties, coverage for sequences.

For sequence coverage, the statement appears as:

```

cover property ( sequence_spec sequence_expr ) statement_or_null

```

LRM 278

The results of coverage statement for a property shall contain:

- Number of times attempted
- Number of times succeeded
- Number of times failed
- Number of times succeeded because of vacuity

In addition, *statement_or_null* is executed every time a property succeeds.

Vacuity rules are applied only when implication operator is used. A property succeeds non-vacuously only if the consequent of the implication contributes to the success.

Results of coverage for a sequence shall include:

- Number of times attempted
- Number of times matched (each attempt can generate multiple matches)

In addition, *statement_or_null* gets executed for every match. If there are multiple matches at the same time, the statement gets executed multiple times, one for each match.

17.13.4 Using concurrent assertion statements outside of procedural code

A concurrent assertion statement can be used outside of a procedural context. It can be used within a module ~~as a module_common_item~~, an interface ~~as a module_common_item~~, or a program ~~as a non_port_item~~. A concurrent assertion statement is either an **assert**, an **assume**, or a **cover** statement. Such a concurrent assertion statement uses the **always** semantics.

LRM 210
LRM 240

The following two forms are equivalent:

```
assert property ( property_spec ) action_block

always assert property ( property_spec ) action_block ;
```

Similarly, the following two forms are equivalent:

```
cover property ( property_spec ) statement_or_null

always cover property ( property_spec ) statement_or_null
```

For example:

```
module top(input bit clk);
  logic a,b,c;
  property rule3;
    @(posedge clk) a |-> b ##1 c;
  endproperty
  a1: assert property (rule3);
  ...
endmodule
```

rule3 is a property declared in module top. The assert statement a1 starts checking the property from the beginning to the end of simulation. The property is always checked. Similarly,

```
module top(input bit clk);
  logic a,b,c;
  sequence seq3;
    @(posedge clk) b ##1 c;
  endsequence
  c1: cover property (seq3);
  ...
endmodule
```

LRM 177

The cover statement c1 starts coverage of the sequence seq3 from beginning to the end of simulation. The sequence is always monitored for coverage.

17.13.5 Embedding concurrent assertions in procedural code

A concurrent assertion statement can also be embedded in a procedural block ~~as a statement_item~~. For example:

LRM 240

```
property rule;
  a ##1 b ##1 c;
```

```

    endproperty

    always @(posedge clk) begin
        <statements>;
        assert property (rule);
    end

```

LRM 177

If the statement appears in an **always** block, the property is always monitored. If the statement appears in an **initial** block, then the monitoring is performed only on the first clock tick.

Two inferences are made from the procedural context: clock from the event control of an **always** block, and the enabling conditions.

A clock is inferred if the statement is placed in an **always** or **initial** block with an event control abiding by the following rules:

- The clock to be inferred must be placed as the first term of the event control as an edge specifier (**posedge expression** or **negedge expression**).
- The variables in *expression* must not be used anywhere in the **always** or **initial** block.

For example:

```

property r1;
    q != d;
endproperty
always @(posedge mclk) begin
    q <= d1;
    r1_p: assert property (r1);
end

```

The above property can be checked by writing statement `r1_p` outside the `always` block, and declaring the property with the clock as:

```

property r1;
    @(posedge mclk) q != d;
endproperty
always @(posedge mclk) begin
    q <= d1;
end
r1p: assert property (r1);

```

If the clock is explicitly specified with a property, then it must be identical to the inferred clock, as shown below:

```

property r2;
    @(posedge mclk) (q != d);
endproperty
always @(posedge mclk) begin
    q <= d1;
    r2_p: assert property (r2);
end

```

In the above example, `(posedge mclk)` is the clock for property `r2`.

Another inference made from the context is the enabling condition for a property. Such derivation takes place when a property is placed in an **if...else** block or a **case** block. The enabling condition assumed from the context is used as the antecedent of the property.

```

property r3;

```



```

    @(posedge mclk) (q != d);
endproperty
always @(posedge mclk) begin
    if (a) begin
        q <= d1;
        r3_p: assert property (r3);
    end
end
end

```

LRM 177

The above example is equivalent to:

```

property r3;
    @(posedge mclk) a |-> (q != d);
endproperty
r3_p: assert property (r3);
always @(posedge mclk) begin
    if (a) begin
        q <= d1;
    end
end
end

```

LRM 177

Similarly, the enabling condition is also inferred from **case** statements.

```

property r4;
    @(posedge mclk) (q != d);
endproperty
always @(posedge mclk) begin
    case (a)
        1: begin q <= d1;
            r4p: assert property (r4);
        end
        default: q1 <= d1;
    endcase
end
end

```

LRM 177

The above example is equivalent to:

```

property r4;
    @(posedge mclk) (a==1) |-> (q != d);
endproperty
r4_p: assert property (r4);
always @(posedge mclk) begin
    case (a)
        1: begin q <= d1;
            end
        default: q1 <= d1;
    endcase
end
end

```

LRM 177

The enabling condition is inferred from procedural code inside an **always** or **initial** block, with the following restrictions:

- 1) There must not be a preceding statement with a timing control.
- 2) A preceding statement shall not invoke a task call which contains a timing control on any statement.
- 3) The concurrent assertion statement shall not be placed in a looping statement, immediately, or in any nested scope of the looping statement.

17.14 Clock resolution

There are a number of ways to specify a clock for a property:

— sequence instance with a clock, for example

```
sequence s2; @(posedge clk) a ##2 b; endsequence
property p2; not s2; endproperty
assert property (p2);
```

— property, for example:

```
property p3; @(posedge clk) not (a ##2 b); endproperty
assert property (p3);
```

— contextually inferred clock from a procedural block, for example:

```
always @(posedge clk) assert property (not (a ##2 b));
```

— clocking block, for example:

LRM 137

```
clocking master_clk @(posedge clk);
property p3; not (a ##2 b); endproperty
endclocking
assert property (master_clk.p3);
```

— default clock, for example:

```
default clocking master_clk @(posedge clk); // master clock as defined above
property p4; (a ##2 b); endproperty
assert property (p4);
```

LRM 239

LRM 177

For a multi-clocked assertion, the clocks are explicitly specified. No default clock or inferred clock is used. In addition, multi-clocked properties are not allowed to be defined within a clocking block.

LRM 137

A multi-clocked property assert statement must not be embedded in procedural code where a clock is inferred. For example, following forms are not allowed.

```
always @(clk) assert property (mult_clock_prop); // illegal
initial @(clk) assert property (mult_clock_prop); // illegal
```

The rules for an assertion with one clock are discussed in the following paragraphs.

The clock for an assertion statement is determined in the decreasing order of priority:

- 1) Explicitly specified clock for the assertion.
- 2) Inferred clock from the context of the code when embedded.
- 3) Default clock, if specified.

A concurrent assertion statement must resolve to a clock. Otherwise, the statement is considered illegal.

Sequences and properties specified in clocking blocks resolve the clock by the following rules:

LRM 137

- 1) Event control of the clocking block specifies the clock.
- 2) No explicit event control is allowed in any property or sequence declaration.
- 3) If a named sequence that is defined outside the clocking block is used, its clock, if specified, must be identical to the clocking block's clock.

4) Multi-clock properties are not allowed.

Resolution of clock for a sequence **definition declaration** assumes that only one explicit event control can be specified. Also, the named sequences used in the sequence **definition declaration** can, but do not need to, contain event control in their definitions.

LRM 238

```
sequence s;
  //sequence composed of two named sub-sequences
  @(posedge s_clk) e ##1 s1 ##1 s2 ##1 f;
endsequence
sequence s1;
  @(posedge clk1) a ##1 b; // single clock sequence
endsequence
sequence s2;
  @(posedge clk2) c ##1 d; // single clock sequence
endsequence
```

These example sequences are used in Table 17-3 to explain the clock resolution rules for a sequence **definition declaration**. The clock of any sequence when explicitly specified is indicated by X. Otherwise, it is indicated by a dash.

LRM 238

LRM 178

Table 17-3: Resolution of clock for a sequence **definition declaration**

s_clk	clk1	clk2	Resolved clock	Semantic restriction
-	-	-	unlocked	-
X	-	-	s_clk	-
X	X	-	s_clk	s_clk and clk1 must be identical
X	X	X	s_clk	s_clk, clk1 and clk2 must be identical
X	-	X	s_clk	s_clk and clk2 must be identical
-	X	-	unlocked	-
-	X	X	unlocked	clk1 and clk2 must be identical
-	-	X	unlocked	-

Once the clock for a sequence **definition declaration** is determined, the clock of a property **definition declaration** is resolved similar to the resolution for a sequence **definition declaration**. A single clocked property assumes that only one explicit event control can be specified. Also, the named sequences used in the property **definition declaration** can contain event control in their **definitions declarations**. Table 17-4 specifies the rules for property **definition declaration** clock resolution. The property has the form:

LRM 238

```
property p;
  @(posedge p_clk) not s1 | => s2;
endproperty
```

p_clk is the property for the clock, clk1 is the clock for sequence s1 and clk2 is the clock for sequence s2. The same rules apply for operator |->.

Table 17-4: Resolution of clock for a **definition declaration**

LRM 238

p_clk	clk1	clk2	Resolved clock	Semantic restriction
-	-	-	unlocked	-
X	-	-	p_clk	-
X	X	-	p_clk	p_clk and clk1 must be identical
X	X	X	p_clk	p_clk, clk1 and clk2 must be identical
X	-	X	p_clk	p_clk and clk2 must be identical
-	X	-	unlocked	-
-	X	X	unlocked or multi-clock	clk1 and clk2 must be identical. If clk1 and clk2 are different for the case of operator =>, then it is considered a multi-clock implication
-	-	X	unlocked	-

Resolution of clock for an **assert** statement is based on the following assumptions:

- **assert** can appear in an **always** block, **initial** block or outside procedural context
- clock is inferred from an **always** or **initial** block
- default clock can be specified using default clocking block

LRM 137

Table 17-5 specifies the rules for clock resolution when **assert** appears in an **always** or **initial** block, where **i_clk** is the inferred clock from an **always** or **initial** block, **d_clk** is the default clock, and **p_clk** is the property clock.

Table 17-5: Resolution of clock in an **always** or **initial** block

i_clk	d_clk	p_clk	Resolved clock	Semantic restriction
-	-	-	unlocked	Error. An assertion must have a clock
X	-	-	i_clk	-
-	X	-	d_clk	
-	-	X	p_clk	
X	-	X	i_clk	i_clk and p_clk must be identical
X	X	-	i_clk	-
-	X	X	p_clk	
-	-	X	p_clk	-

When the **assert** statement is outside any procedural block, there is no inferred clock. The rules for clock resolution are specified in Table 17-6.

Table 17-6: Resolution of clock outside a procedural block

d_clk	p_clk	Resolved clock	Semantic restriction
–	–	unclocked	Error. An assertion must have a clock
X	–	d_clk	
–	X	p_clk	
X	X	p_clk	

17.14.1 Clock resolution in multiply-clocked properties

LRM 131

Throughout this subsection, s, s_1, s_2 denote sequences **expressions** without clocking events; p, p_1, p_2 denote **property expressions** **properties** without clocking events; m, m_1, m_2 denote multiply-clocked sequences, q, q_1, q_2 denote multiply-clocked **property expressions** **properties**; and c, c_1, c_2 denote non-identical clocking event expressions.

LRM 177

LRM 238

Due to clock flow, juxtaposition of two clocks nullifies the first. This and the nesting of clocking events within other property building operators mean that there are subtleties in the general interpretation of the restrictions about where the clock can change in multiply-clocked properties. For example,

$$@ (c) s \mid \rightarrow @ (c) (p \text{ and } @ (c_1) p_1)$$

appears legal because the antecedent is clocked by c and the consequent begins syntactically with the clocking event $@(c)$. However, the consequent sequence is equivalent to

$$(@ (c) p) \text{ and } (@ (c_1) p_1)$$

and $\mid \rightarrow$ cannot synchronize between clock c from the antecedent and clock c_1 from the second conjunct of the consequent. Similarly,

$$@ (c) s \mid \rightarrow @ (c_1) (@ (c) p)$$

appears illegal due to the apparent clock change from c to c_1 across $\mid \rightarrow$. However, it is legal, although arguably misleading in style, because the consequent property is equivalent to $@(c) p$.

This subsection gives a more precise treatment of the restrictions on multiply-clocked use of $\mid \rightarrow$ and **if...else** than the intuitive discussion in Section 17.12. The present treatment depends on the notion of the set of semantic leading clocks for a multiply-clocked sequence or property.

Some sequences and properties have no explicit leading clock event. Their initial clocking event is inherited from an outer clocking event according to the flow of clocking event scope. In this case, the semantic leading clock is said to be *inherited*. For example, in the property

$$@ (c) s \mid \Rightarrow p \text{ and } @ (c_1) p_1$$

the semantic leading clock of the subproperty p is *inherited* since the initial clock of p is the clock that flows across $\mid \Rightarrow$.

A multiply-clocked sequence has a unique semantic leading clock, defined inductively as follows.

- The semantic leading clock of s is *inherited*.
- The semantic leading clock of $@(c) s$ is c .

- If *inherited* is the semantic leading clock of *m*, then the semantic leading clock of $@(c) m$ is *c*. Otherwise, the semantic leading clock of $@(c) m$ is equal to the semantic leading clock of *m*.
- The semantic leading clock of (m) is equal to the semantic leading clock of *m*.
- The semantic leading clock of $m_1 \#\# m_2$ is equal to the semantic leading clock of m_1 .

The set of semantic leading clocks of a multiply-clocked property is defined inductively as follows.

- The set of semantic leading clocks of *m* is $\{c\}$, where *c* is the unique semantic leading clock of *m*.
- The set of semantic leading clocks of *p* is $\{inherited\}$.
- If *inherited* is an element of the set of semantic leading clocks of *q*, then the set of semantic leading clocks of $@(c) q$ is obtained from the set of semantic leading clocks of *q* by replacing *inherited* by *c*. Otherwise, the set of semantic leading clocks of $@(c) q$ is equal to the set of semantic leading clocks of *q*.
- The set of semantic leading clocks of (q) is equal to the set of semantic leading clocks of *q*.
- The set of semantic leading clocks of **not** *q* is equal to the set of semantic leading clocks of *q*.
- The set of semantic leading clocks of q_1 and q_2 is the union of the set of semantic leading clocks of q_1 with the set of semantic leading clocks of q_2 .
- The set of semantic leading clocks of q_1 or q_2 is the union of the set of semantic leading clocks of q_1 with the set of semantic leading clocks of q_2 .
- The set of semantic leading clocks of $m \mid\rightarrow p$ is equal to the set of semantic leading clocks of *m*.
- The set of semantic leading clocks of $m \mid\Rightarrow p$ is equal to the set of semantic leading clocks of *m*.
- The set of semantic leading clocks of **if** (*b*) *q* is $\{inherited\}$.
- The set of semantic leading clocks of **if** (*b*) q_1 **else** q_2 is $\{inherited\}$.
- The set of semantic leading clocks of a property instance is equal to the set of semantic leading clocks of the multiply-clocked property obtained from the body of its **definition declaration** by substituting in actual arguments.

LRM 238

For example, the multiply-clocked sequence

```
@(c1) s1 ## @(c2) s2
```

has c_1 as its unique semantic leading clock, while the multiply-clocked property

```
not (p1 and @(c2) p2)
```

has $\{inherited, c_2\}$ as its set of semantic leading clocks.

In the presence of an incoming outer clock, the inherited semantic leading clock is always understood to refer to the incoming outer clock. On the other hand, if a property has only explicit semantic leading clocks, then the incoming outer clock has no effect on the clocking of the property since the explicit clock events replace the incoming outer clock. Therefore, the clocking of a property *q* in the presence of incoming outer clock *c* is equivalent to the clocking of the property $@(c) q$.

The rules for using multiply-clocked overlapping implication and **if/if...else** in the presence of an incoming outer clock can now be stated more precisely.

1) Multiply-clocked overlapping implication.

Let *c* be the incoming outer clock. Then the clocking of $m \mid\rightarrow q$ is equivalent to the clocking of $@(c) m \mid\rightarrow q$

In the presence of the incoming outer clock, m has a well-defined ending clock, and there is a well-defined clock that flows across $|->$. The multiply-clocked overlapped implication $m |-> q$ is legal for incoming clock c if and only if the following two conditions are met:

- a) Every explicit semantic leading clock of q is identical to the ending clock of m .
- b) If *inherited* is a semantic leading clock of q , then the ending clock of m is equal to the clock that flows across $|->$.

For example

$$@ (c) s \text{ } |-> p_1 \text{ or } @(c_2) p_2$$

is not legal because the ending clock of the antecedent is c , while the consequent has c_2 as an explicit semantic leading clock.

Also,

$$@ (c) s \text{ } ## (@(c_1) s_1) \text{ } |-> p$$

is not legal because the set of semantic leading clocks of p is $\{inherited\}$, the ending clock of the antecedent is c_1 , and the clock that flows across $|->$ and is inherited by p is c .

On the other hand,

$$@ (c) s \text{ } |-> p_1 \text{ or } @(c) p_2$$

and

$$@ (c) s \text{ } ## @(c_1) s_1 \text{ } |-> p_1 \text{ or } @(c_1) p_2$$

are both legal.

2) Multiply-clocked **if/if...else**

Let c be the incoming outer clock. Then the clocking of **if** (b) q_1 [**else** q_2] is equivalent to the clocking of

$$@ (c) \text{ if } (b) q_1 \text{ [else } q_2 \text{]}$$

The boolean condition b is clocked by c , so the multiply-clocked **if/if...else** **if** (b) q_1 [**else** q_2] is legal for incoming clock c if and only if the following condition is met:

- Every explicit semantic leading clock of q_1 [**or** q_2] is identical to c .

For example,

$$@ (c) \text{ if } (b) p_1 \text{ else } @(c) p_2$$

is legal, but

$$@ (c) \text{ if } (b) @(c) (p_1 \text{ and } @(c_2) p_2)$$

is not.

17.15 Binding properties to scopes or instances

To facilitate verification separate from the design, it is possible to specify properties and bind them to specific modules or instances. The following are the goals of providing this feature:

- It allows verification engineers to verify with minimum changes to the design code/files.
- It allows a convenient mechanism to attach verification IP to a module or an instance.

- No semantic changes to the assertions are introduced due to this feature. It is equivalent to writing properties external to a module, using hierarchical path names.

With this feature, a user can bind a module, interface, or program instance to a module or a module instance.

The syntax of the `bind` construct is:

```
bind_directive ::= //from Annex A.1.5
    bind module_identifier bind_instantiation ;
    | bind name_of_instance bind_instantiation ;
bind_instantiation ::=
    program_instantiation
    | module_instantiation
    | interface_instantiation
```

Syntax 17-17—*bind construct syntax (excerpt from Annex A)*

The `bind` directive can be specified in

- a module ~~as a module or generate item~~
- ~~outside of all other declarations in a compilation unit~~
- an interface
- a compilation-unit scope

LRM 240

A program block contains non-design code (either testbench or properties) and executes in the Reactive region, as explained in Section 16.

Example of binding a program instance to a module:

```
bind cpu fpu_props fpu_rules_1(a,b,c);
```

Where:

- `cpu` is the name of module.
- `fpu_props` is the name of the program containing properties.
- `fpu_rules_1` is the program instance name.
- Ports (`a`, `b`, `c`) get bound to signals (`a`, `b`, `c`) of module `cpu`.
- Every instance of `cpu` gets the properties.

Example of binding a program instance to a specific instance of a module:

```
bind cpu1 fpu_props fpu_rules_1(a,b,c);
```

By binding a program to a module or an instance, the program becomes part of the bound object. The names of assertion-related declarations can be referenced using the SystemVerilog hierarchical naming conventions.

Binding of a module instance or an interface instance works the same way as described for programs above.

```
interface range (input clk,enable, input int minval,expr);
    property crange_en;
        @(posedge clk) enable |-> (minval <= expr);
    endproperty
range_chk: assert property (crange_en);
```

LRM 177

```

endinterface

bind cr_unit range r1(c_clk,c_en,v_low,(in1&&in2));

```

In this example, interface `range` is instantiated in the module `cr_unit`. Effectively, every instance of module `cr_unit` shall contain the interface instance `r1`.

17.16 The expect statement

LRM 73

The **expect** statement is a procedural blocking statement that allows a property to be declared and also to wait for the first successful match of the property. The syntax of the **expect** statement is given below.

<pre> expect_property_statement ::= expect (property_spec) action_block </pre>	<i>// from Annex A.2.10</i>
---	-----------------------------

LRM 136

Syntax 17-18—expect statement syntax (excerpt from Annex A)

The **expect** statement accepts the same syntax used to assert a property. An **expect** statement causes the executing process to block until the given property successor fails. The **expect** statement unblocks at the earliest match of the property (i.e., `first_match`). The statement following the **expect** is scheduled to execute after processing the Observe region following the success of the property, or the first failed attempt. In either case (i.e., the property succeeds or fails), the specified property terminates its evaluation when the process unblocks.

When executed, the **expect** statement automatically starts evaluating the given property on the subsequent clocking event, that is, the first attempt shall take place on the next clocking event. When the process unblocks (due to the property succeeding or failing) the property stops being evaluated. If the property fails at its clocking event, the optional **else** clause of the action block is executed. If the property succeeds the optional pass statement of the action block is executed.

The semantics of the **expect** statement are to block until first match (or failure) of the given property and whose starting time is greater than the time at which the expect statement executes.

```

program tst;
    initial begin
        # 200ms;
        expect( @(posedge clk) a ##1 b ##1 c ) else $error( "expect failed" );
        ABC: ...
    end
endprogram

```

In the above example, the **expect** statement blocks the second statement in the initial block of program `tst` until the sequence `a -> b -> c` is recognized starting with the following clocking event (posedge `clk`) after 200ms. If the sequence is matched at the corresponding time, the process is unblocked and continues to execute on the statement labeled `ABC`. If the sequence fails then the **else** clause is executed, which in this case generates a run-time error. For the expect above to succeed, the sequence `a -> b -> c` must start on the clocking event (posedge `clk`) immediately after time 200ms. If `a` is false on the first clocking event after 200ms, the **expect** fails. If `a` is true on the first clocking event after 200ms and `b` is false one clocking event later, the **expect** will also fail.

The **expect** statement can be incorporated in any procedural code, including tasks or class methods. Because it is a blocking statement, the property expression can safely refer to automatic variables as well as static variables. For example, the task below waits between 1 and 10 cycles for the variable `data` to have a particular value, which is an automatic argument. The second argument is used to return the result of the expect, 1 for success and 0 for failure.

```
integer data;
...
task automatic wait_for( integer value, output bit success );
expect( @(posedge clk) ##[1:10] data == value ) success = 1;
    else success = 0;
endtask

initial begin
    bit ok;
    wait_for( 23, ok ); // wait for the value 23
    ...
end
```

Section 18 Hierarchy

18.1 Introduction (informative)

Verilog has a simple organization. All data, functions and tasks are in modules except for system tasks and functions, which are global, and can be defined in the PLI. A Verilog module can contain instances of other modules. Any uninstantiated module is at the top level. This does not apply to libraries, which therefore have a different status and a different procedure for analyzing them. A hierarchical name can be used to specify any named object from anywhere in the instance hierarchy. The module hierarchy is often arbitrary and a lot of effort is spent in maintaining port lists.

In Verilog, only `net`, `reg`, `integer` and `time` data types can be passed through module ports.

SystemVerilog adds many enhancements for representing design hierarchy:

- Packages containing declarations such as data, types, classes, tasks and functions
- Separate compilation support
- A compilation-unit scope visible only within a compilation unit
- ~~Removal of the \$root global declaration space from SystemVerilog 3.1~~
- Nested module declarations, to aid in representing self-contained models and libraries
- Relaxed rules on port declarations
- Simplified named port connections, using `.name`
- Implicit port connections, using `.*`
- Time unit and time precision specifications bound to modules
- A concept of interfaces to bundle connections between modules (presented in Section 19)

LRM 58

LRM 224

An important enhancement in SystemVerilog is the ability to pass any data type through module ports, including nets, and all variable types including reals, arrays, and structures.

18.2 Packages

SystemVerilog packages provide an additional mechanism for sharing parameters, data, type, task, function, sequence, and property declarations amongst multiple SystemVerilog modules, interfaces and programs. Packages are explicitly named scopes appearing at the outermost level of the source text (at the same level as top-level modules and primitives). Types, variables, tasks, functions, sequences, and properties may be declared within a package. Such declarations may be referenced within modules, macromodules, interfaces, programs, and other packages by either import or fully resolved name.

LRM 58
LRM 65
LRM 77
LRM 99

```

package_declaration ::=                                     //from Annex A.1.3
    { attribute_instance } package package_identifier ;
    [ timeunits_declaration ] { { attribute_instance } package_item }
    endpackage [ : package_identifier ]

package_item ::=                                         //from Annex A.1.10
    package_or_generate_item_declaration
  | specparam_declaration
  | concurrent_assertion_item_declaration
  | anonymous_program
  | timeunits_declaration19

package_or_generate_item_declaration ::=
    net_declaration
  | data_declaration
  | task_declaration
  | function_declaration
  | dpi_import_export
  | extern_constraint_declaration
  | extern_method_declaration
  | class_declaration
  | class\_constructor\_declaration
  | parameter_declaration ;
  | local_parameter_declaration
  | covergroup_declaration
  | overload_declaration
  | concurrent\_assertion\_item\_declaration

anonymous_program ::= program ; { anonymous_program_item } endprogram
anonymous_program_item ::=
    task_declaration
  | function_declaration
  | class_declaration
  | covergroup_declaration
  | class\_constructor\_declaration

```

LRM 207
LRM 240
LRM 249
LRM 250

Syntax 18-1—Package declaration syntax (excerpt from Annex A)

The **package** declaration creates a scope that contains declarations intended to be shared among one or more compilation units, modules, macromodules, interfaces, or programs. Items within packages are generally type definitions, tasks, and functions. Items within packages cannot have hierarchical references. It is also possible to populate packages with parameters, variables and nets. This may be useful for global items that aren't conveniently passed down through the hierarchy. Variable declaration assignments within the package shall occur before any **initial**, **always**, **always_comb**, **always_latch** or **always_ff** blocks are started, in the same way as variables declared in a compilation unit or module.

The following is an example of a package:

```

package ComplexPkg;
  typedef struct {
    float i, r;
  } Complex;

  function Complex add(Complex a, b);
    add.r = a.r + b.r;
    add.i = a.i + b.i;

```

LRM 224

```

endfunction

function Complex mul(Complex a, b);
    mul.r = (a.r * b.r) + (a.i * b.i);
    mul.i = (a.r * b.i) + (a.i * b.r);
endfunction
endpackage : ComplexPkg

```

18.2.1 Referencing data in packages

Packages must exist in order for the items they define to be recognized by the scopes in which they are imported.

One way to use declarations made in a package is to reference them using the scope resolution operator “:”.

```
ComplexPkg::Complex cout = ComplexPkg::mul(a, b);
```

An alternate method for utilizing package declarations is via the **import** statement.

```

data_declaration ::= // from Annex A.2.1.3
    ...
    | package_import_declaration
package_import_declaration ::=
    import package_import_item { , package_import_item } ;
package_import_item ::=
    package_identifier :: identifier
    | package_identifier :: *

```

Syntax 18-2—Package import syntax (excerpt from Annex A)

The **import** statement provides direct visibility of identifiers within packages. It allows identifiers declared within packages to be visible within the current scope without a package name qualifier. ~~Hierarchical references to imported identifiers are allowed as if they were defined in the importing scope.~~ Two forms of the import statement are provided: explicit import, and wildcard import. Explicit import allows control over precisely which symbols are imported:

LRM 205

```

import ComplexPkg::Complex;
import ComplexPkg::add;

```

~~An explicit import is treated like a local declaration.~~ An explicit import shall be illegal if the imported identifier is declared in the same scope or explicitly imported from another package. Importing an identifier from the same package multiple times is allowed.

A wildcard import allows all identifiers declared within a package to be imported provided the identifier is not otherwise defined in the importing scope:

```
import ComplexPkg::*;
```

A wildcard import makes each identifier within the package a candidate for import. Each such identifier is imported only when it is referenced in the importing scope and it is neither declared nor explicitly imported into the scope. Similarly, a wildcard import of an identifier is overridden by a subsequent declaration of the same identifier in the same scope. If the same identifier is wildcard imported into a scope from two different packages, the identifier shall be undefined within that scope and result in an error if the identifier is used.

LRM 194

18.2.2 Search order Rules

Table 18-1 describes the search order rules for the declarations imported from a package. For the purposes of the discussion below, consider the following package declarations:

```

package p;
  typedef enum { FALSE, TRUE } BOOL;
  const BOOL c = FALSE;
endpackage

package q;
  const int c = 0;
endpackage

```

Table 18-1: Scoping Rules for Package Importation

Example	Description	Scope containing a local declaration of c	Scope not containing a local declaration of c	Scope containing a declaration of c imported using import q:c	Scope containing a declaration of c imported as import q::*
<pre> u = p::c; y = p::TRUE; </pre>	A qualified package identifier is visible in any scope (without the need for an import clause).	OK Direct reference to c refers to the locally declared c. p::c refers to the c in package p.	OK Direct reference to c is illegal since it is undefined. p::c refers to the c in package p.	OK Direct reference to c refers to the c imported from q. p::c refers to the c in package p.	OK Direct reference to c refers to the c imported from q. p::c refers to the c in package p.
<pre> import p::*; . . . y = FALSE; </pre>	All declarations inside package p become potentially directly visible in the importing scope: – c – BOOL – FALSE – TRUE	OK Direct reference to c refers to the locally declared c. Direct reference to other identifiers (e.g., FALSE) refer to those implicitly imported from package p.	OK Direct reference to c refers to the c imported from package p.	OK Direct reference to c refers to the c imported from package q.	OK / ERROR c is undefined in the importing scope. Thus, a direct reference to c is illegal and results in an error. The import clause is otherwise allowed.
<pre> import p::c; . . . if(! c) ... </pre>	The imported identifiers become directly visible in the importing scope: – c	ERROR “	OK Direct reference to c refers to the c imported from package p.	ERROR It shall be illegal to import an identifier defined in the importing scope.	OK / ERROR The import of p::c makes any prior reference to c illegal. Otherwise, direct reference to c refers to the c imported from package p.

When using a wildcard import, a reference to an undefined identifier that is declared within the package causes that identifier to be imported into the local scope. However, an error results if the same identifier is later declared or explicitly imported. This is shown in the following example:

```
module foo;
  import q::*;
  wire a = c; // This statement forces the import of q::c;
  import p::c; // The conflict with q::c and p::c creates an error.
endmodule
```

18.3 Compilation unit support

LRM 58

SystemVerilog supports separate compilation using compiled units. The following terms and definitions are provided:

- *compilation unit*: a collection of one or more SystemVerilog source files compiled together
- *compilation-unit scope*: a scope that is local to the compilation unit. It contains all declarations that lie outside of any other scope
- *\$unit*: the name used to explicitly access the identifiers in the compilation-unit scope

The exact mechanism for defining which files constitute a compilation unit is tool specific. Tools shall provide a mechanism to specify the files that make up a compilation unit. Two extreme cases are:

- 1) All files make a single compilation unit (in which case the declarations in the compilation-unit scope are accessible anywhere within the design)
- 2) Each file is a separate compilation unit (in which case the declarations in each compilation-unit scope are accessible only within its corresponding file)

The contents of files included using one or more ``include` directives become part of the compilation unit of the file they are included within.

If there is a declaration that is incomplete at the end of a file, then the compilation unit including that file will extend through each successive file until there are no incomplete declarations at the end of the group of files.

The default is that each file is a separate compilation unit.

A tool must also provide a mechanism (such as a command line switch) that specifies that all of the files compiled together are a single compilation unit.

There are other possible mappings of files to compilation units and the mechanism for defining them are tool specific and may not be portable.

The compilation-unit scope can contain any item that can be defined within a package. These items are in the compilation-unit scope name space.

The following items are visible in all compilation units: modules, macromodules, primitives, programs, interfaces, and packages. Items defined in the compilation-unit scope cannot be accessed by name from outside the compilation unit. Access to the items in a compilation-unit scope can be accessed using the PLI, which must provide an iterator to traverse all the compilation units.

In Verilog, compiler directives once seen by a tool apply to all forthcoming source text. This behavior shall be supported within a separately compiled unit; however, compiler directives from one separately compiled unit shall not affect other compilation units. This may result in a difference of behavior between compiling the units separately or as a single compilation unit containing the entire source.

When an identifier is referenced within a scope, SystemVerilog follows the Verilog name search rules:

- First, the nested scope is searched (1364-2001 12.6) (including nested module declarations), [including any identifiers made available through package import declarations](#) LRM 233
- Next, the compilation-unit scope is searched (including any [symbols identifiers](#) made available through package import declarations) LRM 200
- Finally, the instance hierarchy is searched (1364-2001 12.5)

`$unit` is the name of the scope that encompasses a compilation unit. Its purpose is to allow the unambiguous reference to declarations at the outermost level of a compilation unit (i.e., those in the compilation-unit scope). This is done via the same scope resolution operator used to access package items.

For example:

```
bit b;
task foo;
  int b;
  b = 5 + $unit::b;    // $unit::b is the one outside
endtask
```

The compilation-unit scope allows users to easily share declarations (e.g., types) across the unit of compilation, but without having to declare a package from which the declarations are subsequently imported. Thus, the compilation-unit scope is similar to an implicitly defined anonymous package. Because it has no name, the compilation-unit scope cannot be used with an import statement, and the identifiers declared within the scope are not accessible via hierarchical references. Within a particular compilation unit, however, the special name `$unit` can be used to explicitly access the declarations of its compilation-unit scope.

18.4 Top-level instance LRM 58

The name `$root` is added to unambiguously refer to a top level instance, or to an instance path starting from the root of the instantiation tree. `$root` is the root of the instantiation tree.

For example:

```
$root.A.B    // item B within top instance A
$root.A.B.C  // item C within instance B within instance A
```

`$root` allows explicit access to the top of the instantiation tree. This is useful to disambiguate a local path (which takes precedence) from the rooted path. In Verilog, a hierarchical path is ambiguous. For example, `A.B.C` can mean the local `A.B.C` or the top-level `A.B.C` (assuming there is an instance `A` that contains an instance `B` at both the top level and in the current module). Verilog addresses that ambiguity by giving priority to the local scope, thereby preventing access to the top level path. `$root` allows explicit access to the top level in those cases in which the name of the top level module is insufficient to uniquely identify the path.

18.5 Module declarations

```

module_declaration ::= // from Annex A.1.3
    module_nonansi_header [ timeunits_declaration ] { module_item }
        endmodule [ : module_identifier ]
    | module_ansi_header [ timeunits_declaration ] { non_port_module_item }
        endmodule [ : module_identifier ]
    | { attribute_instance } module_keyword [ lifetime ] module_identifier (.*);
        [ timeunits_declaration ] { module_item } endmodule [ : module_identifier ]
    | extern module_nonansi_header
    | extern module_ansi_header

module_nonansi_header ::=
    { attribute_instance } module_keyword [ lifetime ] module_identifier [ parameter_port_list ]
        list_of_ports ;

module_ansi_header ::=
    { attribute_instance } module_keyword [ lifetime ] module_identifier [ parameter_port_list ]
        [ list_of_port_declarations ] ;

module_keyword ::= module | macromodule

timeunits_declaration ::=
    timeunit time_literal ;
    | timeprecision time_literal ;
    | timeunit time_literal ;
    | timeprecision time_literal ;
    | timeprecision time_literal ;
    | timeunit time_literal ;

```

LRM 26

Syntax 18-3—Module declaration syntax (excerpt from Annex A)

In Verilog, a module must be declared apart from other modules, and can only be instantiated within another module. A module declaration can appear after it is instantiated in the source text.

SystemVerilog adds the capability to nest module declarations.

LRM 58

```

module m1 (...); ... endmodule

module m2 (...); ... endmodule

module m3 (...);

    m1 i1(...); // instantiates the local m1 declared below
    m2 i4(...); // instantiates m2 - no local declaration
    module m1(...); ... endmodule // nested module declaration,
                                // m1 module name is in m3's name space
endmodule

```

18.6 Nested modules

A module can be declared within another module. The outer name space is visible to the inner module, so that any name declared there can be used, unless hidden by a local name, provided the module is declared and instantiated in the same scope.

One purpose of nesting modules is to show the logical partitioning of a module without using ports. Names

that are global are in the outermost scope, and names that are only used locally can be limited to local modules.

```
// This example shows a D-type flip-flop made of NAND gates
module dff_flat(input d, ck, pr, clr, output q, nq);
wire q1, nq1, q2, nq2;

    nand g1b (nq1, d, clr, q1);
    nand g1a (q1, ck, nq2, nq1);

    nand g2b (nq2, ck, clr, q2);
    nand g2a (q2, nq1, pr, nq2);

    nand g3a (q, nq2, clr, nq);
    nand g3b (nq, q1, pr, q);
endmodule

// This example shows how the flip-flop can be structured into 3 RS latches.
module dff_nested(input d, ck, pr, clr, output q, nq);
wire q1, nq1, nq2;

    module ff1;
        nand g1b (nq1, d, clr, q1);
        nand g1a (q1, ck, nq2, nq1);
    endmodule
    ff1 i1();

    module ff2;
        wire q2; // This wire can be encapsulated in ff2
        nand g2b (nq2, ck, clr, q2);
        nand g2a (q2, nq1, pr, nq2);
    endmodule
    ff2 i2();

    module ff3;
        nand g3a (q, nq2, clr, nq);
        nand g3b (nq, q1, pr, q);
    endmodule
    ff3 i3();
endmodule
```

LRM 100

The nested module declarations can also be used to create a library of modules that is local to part of a design.

```
module part1(...);
    module and2(input a, b, output z);
        ....
    endmodule
    module or2(input a, b, output z);
        ....
    endmodule
    ....
    and2 u1(...), u2(...), u3(...);
    ....
endmodule
```

LRM 100

This allows the same module name, e.g. and2, to occur in different parts of the design and represent different modules. Note that an alternative way of handling this problem is to use configurations.

Nested modules with no ports that are not explicitly instantiated shall be implicitly instantiated once with an

LRM 166

instance name identical to the module name. Otherwise, if they have ports and are not explicitly instantiated, they are ignored.

18.7 Extern modules

LRM 168

To support separate compilation, extern declarations of a module can be used to declare the ports on a module without defining the module itself. An extern module declaration consists of the keyword **extern** followed by the module name and the list of ports for the module. Both list of ports syntax (possibly with parameters), and original Verilog style port declarations can be used. Note that the potential existence of defparams precludes the checking of the port connection information prior to elaboration time even for list of ports style declarations.

The following example demonstrates the usage of extern module declarations.

```
extern module m (a,b,c,d);
extern module a #(parameter size= 8, parameter type TP = logic [7:0])
    (input [size:0] a, output TP b);

module top ();
    wire [8:0] a;
    logic [7:0] b;

    m m (.*);
    a a (.*);
endmodule
```

LRM 244

Modules `m` and `a` are then assumed to be instantiated as:

```
module top ();
    m m (a,b,c,d);
    a a (a,b);
endmodule
```

If an **extern** declaration exists for a module, it is possible to use `.*` as the ports of the module. This usage shall be equivalent to placing the ports (and possibly parameters) of the **extern** declaration on the module.

For example,

```
extern module m (a,b,c,d);
extern module a #(parameter size = 8, parameter type TP = logic [7:0])
    (input [size:0] a, output TP b);

module m (.*);
    input a,b,c;
    output d;
endmodule

module a (.*);
    ...
endmodule
```

is equivalent to writing:

```
module m (a,b,c,d);
    input a,b,c;
    output d;
endmodule
```

```

module a #(parameter size = 8, parameter type TP = logic [7:0])
    (input [size:0] a, output TP b);
    ...
endmodule

```

LRM 242

Extern module declarations can appear at any level of the instantiation hierarchy, but are visible only within the level of hierarchy in which they are declared. It shall be an error for the module definition to not exactly match the extern module declaration.

18.8 Port declarations

```

inout_declaration ::= //from Annex A.2.1.2
    inout { port_type } list_of_port_identifiers
    † inout data_type list_of_variable_identifiers
input_declaration ::=
    input { port_type } list_of_port_identifiers
    | input data_type list_of_variable_identifiers
output_declaration ::=
    output { port_type } list_of_port_identifiers
    | output data_type list_of_variable_port_identifiers
interface_port_declaration ::=
    interface_identifier list_of_interface_identifiers
    | interface_identifier . modport_identifier list_of_interface_identifiers
ref_declaration ::= ref data_type list_of_port_identifiers
generic_interface_port_declaration ::=
    interface list_of_interface_identifiers
    † interface . modport_identifier list_of_interface_identifiers
port_type ::= //from Annex A.2.2.1

    data_type
    † net_type [ signing ] { packed_dimension }
    † trireg [ signing ] { packed_dimension }
    † [ signing ] { packed_dimension } range

signing ::= signed | unsigned
port_type ::= //from Annex A.2.2.1
    [ net_type_or_trireg ] [ signing ] { packed_dimension }

```

LRM 218
LRM 243

Syntax 18-4—Port declaration syntax (excerpt from Annex A)

With SystemVerilog, a port can be a declaration of a net, an interface, an event, or a variable of any type, including an array, a structure or a union.

```

typedef struct {
    bit isfloat;
    union { int i; shortreal f; } n;
} tagged_st; // named structure

module mh1 (input int in1, input shortreal in2, output tagged_st out);
    ...
endmodule

```

LRM 162

For the first port, if neither a type nor a direction is specified, then it shall be assumed to be a member of a port

list, and any port direction or type declarations must be declared after the port list. This is compatible with the Verilog-1995 syntax. If the first port type but no direction is specified, then the port direction shall default to **inout**. If the first port direction but no type is specified, then the port type shall default to **wire**. This default type can be changed using the `'default_nettype` compiler directive, as in Verilog.

```
// Any declarations must follow the port list, because first port does not
// have either a direction or type specified; Port directions default to inout
module mh4(x, y);
    wire x;
    tri0 y;
    ...
endmodule
```

For subsequent ports in the port list, if the type and direction are omitted, then both are inherited from the previous port. If only the direction is omitted, then it is inherited from the previous port. If only the type is omitted, it shall default to **wire**. This default type can be changed using the `'default_nettype` compiler directive, as in Verilog.

```
// second port inherits its direction and type from previous port
module mh3 (input byte a, b);
    ...
endmodule
```

Generic interface ports cannot be declared using the Verilog-1995 list of ports style. Generic interface ports can only be declared by using a list of port declaration style.

```
module cpuMod(interface d, interface j);
    ...
endmodule
```

18.9 List of port expressions

LRM 32

Verilog 1364-2001 created a *list_of_port_declarations* alternate style which minimized the duplication of data used to specify the ports of a module. SystemVerilog adds an explicitly named port declaration to that style, allowing elements of arrays and structures, concatenations of elements, or aggregate expressions of elements declared in a module, interface or program to be specified on the port list.

Like explicitly named ports in a module port declaration, port identifiers exist in their own namespace for each port list. When port item is just a simple port identifier, that identifier is used as both a reference to an interface item and a port identifier. Once a port identifier has been defined, there shall not be another port definition with this same name.

For example:

```
module mymod (
    output .P1(r[3:0]),
    output .P2(r[7:4]),
    ref .Y(x),
    input bit R );

    logic [7:0] r;
    int x;
    ...
endmodule
```

The self-determined type of the port expression becomes the type for the port. If the port expression is to be an aggregate expression, then a cast must be used since self-determined aggregate expressions are not allowed. The **port-expression** **port expression** must resolve to a legal expression for type of module port (See section

LRM 243

18.12—Port connection rules). The port expression is optional because ports can be defined that do not connect to anything internal to the port.

18.10 Time unit and precision

SystemVerilog has a time unit and precision declaration which has the equivalent functionality of the ``timescale` compiler directives in Verilog-2001. Use of these declarations removes the file order dependencies problems with compiler directives. The time unit and precision can be declared by the `timeunit` and `timeprecision` keywords, respectively, and set to a time literal which must be a power of 10 units. For example:

```
timeunit 100ps;  
timeprecision 10fs;
```

There shall be at most one time unit and one time precision for any module, program, package or interface definition, or in any compilation-unit scope. This shall define a time scope. If specified, the `timeunit` and `timeprecision` declarations shall precede any other items in the current time scope. The `timeunit` and `timeprecision` declarations can be repeated as later items, but must match the previous declaration within the current time scope.

LRM 58

If a `timeunit` is not specified in the module, program, package or interface definition, then the time unit is shall be determined using the following rules of precedence:

- 1) If the module or interface definition is nested, then the time unit shall be inherited from the enclosing module or interface (programs and packages cannot be nested).
- 2) Else, if a ``timescale` directive has been previously specified (within the compilation unit), then the time unit shall be set to the units of the last ``timescale` directive.
- 3) Else, if the compilation-unit scope specifies a time unit (outside all other declarations), then the time unit shall be set to the time units of the compilation unit.
- 4) Else, the default time unit shall be used.

The time unit of the compilation-unit scope can only be set by a `timeunit` declaration, not a ``timescale` directive. If it is not specified then the default time unit shall be used.

If a `timeprecision` is not specified in the current time scope, then the time precision shall be determined following the same precedence as with time units.

The global time precision is the minimum of all the `timeprecision` statements and the smallest time precision argument of all the ``timescale` compiler directives (known as the precision of the time unit of the simulation in Section 19.8 of the IEEE 1364-2001 standard) in the design. The `step` time unit is equal to the global time precision.

18.11 Module instances

```

module_instantiation ::=                                     //from Annex A.4.1.1
    module_identifier [ parameter_value_assignment ] hierarchical_instance { , hierarchical_instance };
parameter_value_assignment ::= # ( list_of_parameter_assignments )
list_of_parameter_assignments ::=
    ordered_parameter_assignment { , ordered_parameter_assignment }
    | named_parameter_assignment { , named_parameter_assignment }
ordered_parameter_assignment ::= param_expression
named_parameter_assignment ::= . parameter_identifier ( [ param_expression ] )
hierarchical_instance ::= name_of_instance ( [ list_of_port_connections ] )
name_of_instance ::= instance_identifier { unpacked_dimension }
list_of_port_connections18 ::=
    ordered_port_connection { , ordered_port_connection }
    | named_port_connection { , named_port_connection }
ordered_port_connection ::= { attribute_instance } [ expression ]
named_port_connection ::=
    { attribute_instance } . port_identifier ( ( [ expression ] ) )
    | { attribute_instance } .*
param_expression ::= mintypmax_expression | data_type                                     //from Annex A.8.3

```

LRM 172

LRM 93

Syntax 18-5—Module instance syntax (excerpt from Annex A)

A module can be used (instantiated) in two ways, hierarchical or top level. Hierarchical instantiation allows more than one instance of the same type. The module name can be a module previously declared or one declared later. Actual parameters can be named or ordered. Port connections can be named, ordered or implicitly connected. They can be nets, variables, or other kinds of interfaces, events, or expressions. See below for the connection rules.

Consider an ALU accumulator (`alu_accum`) example module that includes instantiations of an ALU module, an accumulator register (`accum`) module and a sign-extension (`xtend`) module. The module headers for the three instantiated modules are shown in the following example code.

```

module alu (
    output reg [7:0] alu_out,
    output reg zero,
    input [7:0] ain, bin,
    input [2:0] opcode);
    // RTL code for the alu module
endmodule

module accum (
    output reg [7:0] dataout,
    input [7:0] datain,
    input clk, rst_n);
    // RTL code for the accumulator module
endmodule

module xtend (
    output reg [7:0] dout,
    input din,
    input clk, rst_n);

```

```
// RTL code for the sign-extension module
endmodule
```

18.11.1 Instantiation using positional port connections

Verilog has always permitted instantiation of modules using positional port connections, as shown in the `alu_accum1` module example, below.

```
module alu_accum1 (
    output [15:0] dataout,
    input [7:0] ain, bin,
    input [2:0] opcode,
    input clk, rst_n);
    wire [7:0] alu_out;

    alu alu (alu_out, , ain, bin, opcode);
    accum accum (dataout[7:0], alu_out, clk, rst_n);
    xtend xtend (dataout[15:8], alu_out[7], clk, rst_n);
endmodule
```

As long as the connecting variables are ordered correctly and are the same size as the instance-ports that they are connected to, there shall be no warnings and the simulation shall work as expected.

18.11.2 Instantiation using named port connections

Verilog has always permitted instantiation of modules using named port connections as shown in the `alu_accum2` module example.

```
module alu_accum2 (
    output [15:0] dataout,
    input [7:0] ain, bin,
    input [2:0] opcode,
    input clk, rst_n);
    wire [7:0] alu_out;

    alu alu (.alu_out(alu_out), .zero(),
            .ain(ain), .bin(bin), .opcode(opcode));
    accum accum (.dataout(dataout[7:0]), .datain(alu_out),
                .clk(clk), .rst_n(rst_n));
    xtend xtend (.dout(dataout[15:8]), .din(alu_out[7]),
                .clk(clk), .rst_n(rst_n));
endmodule
```

Named port connections do not have to be ordered the same as the ports of the instantiated module. The variables connected to the instance ports must be the same size or a port-size mismatch warning shall be reported.

18.11.3 Instantiation using implicit `.name` port connections

SystemVerilog adds the capability to implicitly instantiate ports using a `.name` syntax if the instance-port name and size match the connecting variable-port name and size. This enhancement eliminates the requirement to list a port name twice when the port name and signal name are the same, while still listing all of the ports of the instantiated module for documentation purposes.

In the following `alu_accum3` example, all of the ports of the instantiated `alu` module match the names of the variables connected to the ports, except for the unconnected zero port, which is listed using a named port connection, showing that the port is unconnected. Implicit `.name` port connections are made for all name and size matching connections on the instantiated module.

In the same `alu_accum3` example, the `accum` module has an 8-bit port called `dataout` that is connected to a

16-bit bus called `dataout`. Because the internal and external sizes of `dataout` do not match, the port must be connected by name, showing which bits of the 16-bit bus are connected to the 8-bit port. The `datain` port on the `accum` is connected to a bus by a different name (`alu_out`), so this port is also connected by name. The `clk` and `rst_n` ports are connected using implicit `.name` port connections. Also in the same `alu_accum3` example, the `xtend` module has an 8-bit output port called `dout` and a 1-bit input port called `din`. Since neither of these port names match the names (or sizes) of the connecting variables, both are connected by name. The `clk` and `rst_n` ports are connected using implicit `.name` port connections.

```

module alu_accum3 (
    output [15:0] dataout,
    input [7:0] ain, bin,
    input [2:0] opcode,
    input clk, rst_n);
    wire [7:0] alu_out;

    alu alu (.alu_out, .zero(), .ain, .bin, .opcode);
    accum accum (.dataout(dataout[7:0]), .datain(alu_out), .clk, .rst_n);
    xtend xtend (.dout(dataout[15:8]), .din(alu_out[7]), .clk, .rst_n);
endmodule

```

A `.port_identifier` port connection is semantically equivalent to the named port connection `.port_identifier(name)` port connection with the following exceptions:

- The identifier referenced by `.port_identifier` shall not create an implicit wire declaration.
- It shall be illegal for a `.port_identifier` port connection to create an implicit cast. This includes truncation or padding.
- A conversion between a 2-state and 4-state type of the same bit length is a legitimate cast.
- A port connection between a net type and a variable type of the same bit length is a legitimate cast.
- It shall be an error if a `.port_identifier` port connection between two dissimilar net types would generate a warning message as required by the Verilog-2001 standard.

18.11.4 Instantiation using implicit `.*` port connections

SystemVerilog adds the capability to implicitly instantiate ports using a `.*` syntax for all ports where the instance-port name and size match the connecting variable-port name and size. This enhancement eliminates the requirement to list any port where the name and size of the connecting variable match the name and size of the instance port. This implicit port connection style is used to indicate that all port names and sizes match the connections where emphasis is placed only on the exception ports. The implicit `.*` port connection syntax can greatly facilitate rapid block-level testbench generation where all of the testbench variables are chosen to match the instantiated module port names and sizes.

In the following `alu_accum4` example, all of the ports of the instantiated `alu` module match the names of the variables connected to the ports, except for the unconnected zero port, which is listed using a named port connection, showing that the port is unconnected. The implicit `.*` port connection syntax connects all other ports on the instantiated module.

In the same `alu_accum4` example, the `accum` module has an 8-bit port called `dataout` that is connected to a 16-bit bus called `dataout`. Because the internal and external sizes of `dataout` do not match, the port must be connected by name, showing which bits of the 16-bit bus are connected to the 8-bit port. The `datain` port on the `accum` is connected to a bus by a different name (`alu_out`), so this port is also connected by name. The `clk` and `rst_n` ports are connected using implicit `.*` port connections. Also in the same `alu_accum4` example, the `xtend` module has an 8-bit output port called `dout` and a 1-bit input port called `din`. Since neither of these port names match the names (or sizes) of the connecting variables, both are connected by name. The `clk` and `rst_n` ports are connected using implicit `.*` port connections.

```

module alu_accum4 (

```

```

    output [15:0] dataout,
    input [7:0] ain, bin,
    input [2:0] opcode,
    input clk, rst_n);
    wire [7:0] alu_out;

    alu alu    (*, .zero());
    accum accum (*, .dataout(dataout[7:0]), .datain(alu_out));
    xtend xtend (*, .dout(dataout[15:8]), .din(alu_out[7]));
endmodule

```

An implicit `.*` port connection is semantically equivalent to a default `.name` port connection for every port declared in the instantiated module. A named port connection can be mixed with a `.*` connection to override the port connection to a different expression or to leave the port unconnected.

When the implicit `.*` port connection is mixed in the same instantiation with named port connections, the implicit `.*` port connection token can be placed anywhere in the port list. The `.*` token can only appear at most once in the port list.

Modules can be instantiated into the same parent module using any combination of legal positional, named, implicit `.name` connected and implicit `.*` connected instances as shown in `alu_accum5` example.

```

module alu_accum5 (
    output [15:0] dataout,
    input [7:0] ain, bin,
    input [2:0] opcode,
    input clk, rst_n);
    wire [7:0] alu_out;

    // mixture of named port connections and
    // implicit .name port connections
    alu alu    (.ain(ain), .bin(bin), .alu_out, .zero(), .opcode);

    // positional port connections
    accum accum (dataout[7:0], alu_out, clk, rst_n);

    // mixture of named port connections and implicit .* port connections
    xtend xtend (.dout(dataout[15:8]), .*, .din(alu_out[7]));
endmodule

```

18.12 Port connection rules

SystemVerilog extends Verilog port connections by making all variable data types available to pass through ports. It does this by allowing both sides of a port connection to have the same compatible data type, and by allowing continuous assignments to variables. It also creates a new type of port qualifier, `ref`, to allow shared variable behavior across a port by passing a hierarchical reference.

18.12.1 Port connection rules for variables

If a port declaration has a variable data type, then its direction controls how it can be connected when instantiated, as follows:

- An **input** port can be connected to any expression of a compatible data type. A continuous assignment shall be implied when a variable is connected to an input port declaration. Assignments to variables declared as an input port shall be illegal. If left unconnected, the port shall have the default initial value corresponding to the data type.

- An **output** port can be connected to a variable (or a concatenation) of a compatible data type. A continuous assignment shall be implied when a variable is connected the output port of an instance. Procedural or continuous assignments to a variable connected to the output port of an instance shall be illegal.
- An **output** port can be connected to a net (or a concatenation) of a compatible data type. In this case, multiple drivers shall be permitted on the net as in Verilog-2001.
- A variable data type is not permitted on either side of an **inout** port.
- A **ref** port shall be connected to an equivalent variable data type. References to the port variable shall be treated as hierarchal references to the variable it is connected to in its instantiation. This kind of port cannot be left unconnected. See Section 5.8.1, Equivalent types.

LRM 111

18.12.2 Port connection rules for nets

If a port declaration has a **wire** type (which is the default), or any other net type, then its direction controls how it can be connected as follows:

- An **input** can be connected to any expression of a compatible data type. If left unconnected, it shall have the value 'z.
- An **output** can be connected to a net type (or a concatenation of net types) or a compatible variable type (or a concatenation of variable types).
- An **inout** can be connected to a net type (or a concatenation of net types) or left unconnected, but not to a variable type.

Note that where the data types differ between the port declaration and connection, an initial value change event can be caused at time zero.

18.12.3 Port connection rules for interfaces

A port declaration can be a generic interface or named interface type. An interface port instance must always be connected to an interface instance or a higher-level interface port. An interface port cannot be left unconnected.

If a port declaration has a generic interface type, then it can be connected to an interface instance of any type. If a port declaration has a named interface type, then it must be connected to an interface instance of the identical type.

18.12.4 Compatible port types

The same rules for assignment compatibility are used for compatible port types for ports declared as an **input** or an **output** variable, or for **output** ports connected to variables. SystemVerilog does not change any of the other port connection compatibility rules

18.12.5 Unpacked array ports and arrays of instances

For an unpacked array port, the port and the array connected to the port must have the same number of unpacked dimensions, and each dimension of the port must have the same size as the corresponding dimension of the array being connected.

If the size and type of the port connection match the size and type of a single instance port, the connection shall be made to each instance in an array of instances.

If the port connection is an unpacked array, the unpacked array dimensions of each port connection shall be compared with the dimensions of the instance array. If they match exactly in size, each element of the port connection shall be matched to the port left index to left index, right index to right index. If they do not match it shall be considered an error.

If the port connection is a packed array, each instance shall get a part-select of the port connection, starting with all right-hand indices to match the right most part-select, and iterating through the right most dimension first. Too many or too few bits to connect all the instances shall be considered an error.

18.13 Name spaces

SystemVerilog has eight name spaces for identifiers, two are global (definitions name space and package name space), two are global to the compilation unit (compilation unit name space and text macro name space) and four are local. The eight name spaces are described as follows:

LRM 58

- 1) The *definitions name space* unifies all the non-nested **module**, **macromodule**, **primitive**, **program**, and **interface** identifiers defined outside of all other declarations. Once a name is used to define a module, macromodule, primitive, program, or interface within one compilation unit the name shall not be used again (in any compilation unit) to declare another non-nested module, macromodule, primitive, program, or interface outside of all other declarations. This is compatible with the *definitions name space* as defined in IEEE 1364-2001.
- 2) The *package name space* unifies all the **package** identifiers defined among all compilation units. Once a name is used to define a package within one compilation unit the name shall not be used again to declare another package within any compilation unit.
- 3) The *compilation-unit scope name space* exists outside the **module**, **macromodule**, **interface**, **package**, **program**, and **primitive** constructs. It unifies the definitions of the functions, tasks, parameters, named events, net declarations, variable declarations and user defined types within the compilation-unit scope.
- 4) The *text macro name space* is global within the compilation unit. Since text macro names are introduced and used with a leading ` character, they remain unambiguous with any other name space. The text macro names are defined in the linear order of appearance in the set of input files that make up the compilation unit. Subsequent definitions of the same name override the previous definitions for the balance of the input files.
- 5) The *module name space* is introduced by ~~the~~ **module**, **macromodule**, **interface**, **package**, **program**, and **primitive** constructs. It unifies the definition of modules, macromodules, interfaces, programs, functions, tasks, named blocks, instance names, parameters, named events, net declarations, variable declarations and user defined types within the enclosing construct.
- 6) The *block name space* is introduced by named or unnamed blocks, the **specify**, **function**, and **task** constructs. It unifies the definitions of the named blocks, functions, tasks, parameters, named events, variable type of declaration and user defined types within the enclosing construct.
- 7) The *port name space* is introduced by the **module**, **macromodule**, **interface**, **primitive**, and **program** constructs. It provides a means of structurally defining connections between two objects that are in two different name spaces. The connection can be unidirectional (either **input** or **output**) or bidirectional (**inout** or **ref**). The port name space overlaps the module and the block name spaces. Essentially, the port name space specifies the type of connection between names in different name spaces. The port type of declarations includes **input**, **output**, ~~and~~ **inout**, and **ref**. A port name introduced in the port name space can be reintroduced in the module name space by declaring a variable or a net with the same name as the port name.
- 8) The *attribute name space* is enclosed by the (* and *) constructs attached to a language element (see Section 2.8). An attribute name can be defined and used only in the attribute name space. Any other type of name cannot be defined in this name space.

LRM 244

LRM 224

18.14 Hierarchical names

Hierarchical names are also called nested identifiers. They consist of instance names separated by periods, where an instance name can be an array element. The instance name `$root` refers to the top of the instantiated design and is used to unambiguously gain access to the top of the design.

LRM 58

```
$root.mymodule.u1 // absolute name
u1.struct1.field1 // u1 must be visible locally or above, including globally
adder1[5].sum
```

Nested identifiers can be read (in expressions), written (in assignments or task/function calls) or triggered off (in event expressions). They can also be used as **type**, task or function names.

LRM 243

Section 19 Interfaces

19.1 Introduction (informative)

The communication between blocks of a digital system is a critical area that can affect everything from ease of RTL coding, to hardware-software partitioning to performance analysis to bus implementation choices and protocol checking. The interface construct in SystemVerilog was specifically created to encapsulate the communication between blocks, allowing a smooth migration from abstract system-level design through successive refinement down to lower-level register-transfer and structural views of the design. By encapsulating the communication between blocks, the interface construct also facilitates design re-use. The inclusion of interface capabilities is one of the major advantages of SystemVerilog.

LRM 176

At its lowest level, an interface is a named bundle of nets or variables. The interface is instantiated in a design and can be accessed through a port as a single item, and the component nets or variables referenced where needed. A significant proportion of a Verilog design often consists of port lists and port connection lists, which are just repetitions of names. The ability to replace a group of names by a single name can significantly reduce the size of a description and improve its maintainability.

Additional power of the interface comes from its ability to encapsulate functionality as well as connectivity, making an interface, at its highest level, more like a class template. An interface can have parameters, constants, variables, functions and tasks. The types of elements in an interface can be declared, or the types can be passed in as parameters. The member variables and functions are referenced relative to the instance name of the interface as `instance.member`. Thus, modules that are connected via an interface can simply call the task/function members of that interface to drive the communication. With the functionality thus encapsulated in the interface, and isolated from the module, the abstraction level and/or granularity of the communication protocol can be easily changed by replacing the interface with a different interface containing the same members but implemented at a different level of abstraction. The modules connected via the interface don't need to change at all.

To provide direction information for module ports and to control the use of tasks and functions within particular modules, the `modport` construct is provided. As the name indicates, the directions are those seen from the module.

In addition to task/function methods, an interface can also contain processes (i.e. `initial` or `always` blocks) and continuous assignments, which are useful for system-level modeling and testbench applications. This allows the interface to include, for example, its own protocol checker that automatically verifies that all modules connected via the interface conform to the specified protocol. Other applications, such as functional coverage recording and reporting, protocol checking and assertions can also be built into the interface.

The methods can be abstract, i.e. defined in one module and called in another, using the `export` and `import` constructs. This could be coded using hierarchical path names, but this would impede re-use because the names would be design-specific. A better way is to declare the task and function names in the interface, and to use local hierarchical names from the interface instance for both definition and call. Broadcast communication is modeled by `forkjoin` tasks, which can be defined in more than one module and executed concurrently.

19.2 Interface syntax

```

interface_declaration ::=                                     // from Annex A.1.3
    interface_nonansi_header [ timeunits_declaration ] { interface_item }
        endinterface [ : interface_identifier ]
    | interface_ansi_header [ timeunits_declaration ] { non_port_interface_item }
        endinterface [ : interface_identifier ]
    | { attribute_instance } interface interface_identifier ( .* );
        [ timeunits_declaration ] { interface_item }
        endinterface [ : interface_identifier ]
    | extern interface_nonansi_header
    | extern interface_ansi_header

interface_nonansi_header ::=
    { attribute_instance } interface [ lifetime ] interface_identifier
        [ parameter_port_list ] list_of_ports ;

interface_ansi_header ::=
    { attribute_instance } interface [ lifetime ] interface_identifier
        [ parameter_port_list ] [ list_of_port_declarations ] ;

modport_declaration ::= modport modport_item { , modport_item } ;           // from Annex A.2.9
modport_item ::= modport_identifier ( modport_ports_declaration { , modport_ports_declaration } )
modport_ports_declaration ::=
    { attribute_instance } modport_simple_ports_declaration
    | { attribute_instance } modport_hierarchical_ports_declaration
    | { attribute_instance } modport_tf_ports_declaration
    | { attribute_instance } modport_clocking_declaration
modport_clocking_declaration ::= clocking clocking_identifier
modport_simple_ports_declaration ::=
    input list_of_modport_port_identifiers
    † output list_of_modport_port_identifiers
    † inout list_of_modport_port_identifiers
    † ref [ data_type ] list_of_modport_port_identifiers
modport_simple_ports_declaration ::=
    port_direction modport_simple_port { , modport_simple_port }
modport_simple_port ::=
    port_identifier
    | . port_identifier ( [ expression ] )
modport_hierarchical_ports_declaration ::=
    interface_instance_identifier [ [ constant_expression ] ] . modport_identifier
modport_tf_ports_declaration ::=
    import_export modport_tf_port
modport_tf_port ::=
    task named_task_proto { , named_task_proto }
    | function named_function_proto { , named_function_proto }
    | tf_identifier { , tf_identifier }
import_export ::= import | export
interface_instantiation ::=                                     // from Annex A.4.1.2
    interface_identifier [ parameter_value_assignment ] hierarchical_instance { , hierarchical_instance
    } ;

```

LRM 107

LRM 243

LRM 172

Syntax 19-1—Interface syntax (excerpt from Annex A)

The interface construct provides a new hierarchical structure. It can contain smaller interfaces and can be passed through ports.

The aim of interfaces is to encapsulate communication. At the lower level, this means bundling variables and wires in interfaces, and can impose access restrictions with port directions in modports. The modules can be made generic so that the interfaces can be changed. The following examples show these features. At a higher level of abstraction, communication can be done by tasks and functions. Interfaces can include task and function definitions, or just task and function prototypes (see Section 19.6.1 An example of using tasks in an interface) with the definition in one module (server/slave) and the call in another (client/master).

LRM 176

A simple interface declaration is as follows (see Syntax 19-1 for the complete syntax):

```
interface identifier;
    ...
    interface_items
    ...
endinterface [ : identifier ]
```

An interface can be instantiated hierarchically like a module, with or without ports. For example:

```
myinterface #(100) scalar1, vector[9:0];
```

In this example, 11 instances of the interface of type `myinterface` have been instantiated and the first parameter within each interface is changed to 100. One `myinterface` instance is instantiated with the name `scalar1`, and an array of 10 `myinterface` interfaces are instantiated with instance names `vector[9]` to `vector[0]`.

LRM 176

Interfaces can be declared and instantiated in modules (either flat or hierarchical) but modules can neither be declared nor instantiated in interfaces.

The simplest use of an interface is to bundle wires, as is illustrated in the examples below.

19.2.1 Example without using interfaces

This example shows a simple bus implemented without interfaces. Note that the logic type can replace wire and reg if no resolution of multiple drivers is needed.

```
module memMod( input    bit req,
               input    bit clk,
               input    bit start,
               input    logic [1:0] mode,
               input    logic [7:0] addr,
               inout    wire [7:0] data,
               output   bit gnt,
               output   bit rdy );
    logic avail;
    ...
endmodule

module cpuMod(
    input    bit clk,
    input    bit gnt,
    input    bit rdy,
    inout    wire [7:0] data,
    output   bit req,
    output   bit start,
```



```

        logic [7:0] addr,
        logic [1:0] mode );
    ...
endmodule

module top;
    logic req, gnt, start, rdy; // req is logic not bit here
    logic clk = 0;
    logic [1:0] mode;
    logic [7:0] addr;
    wire [7:0] data;

    memMod mem(req, clk, start, mode, addr, data, gnt, rdy);
    cpuMod cpu(clk, gnt, rdy, data, req, start, addr, mode);

endmodule

```

19.2.2 Interface example using a named bundle

The simplest form of a SystemVerilog interface is a bundled collection of variables or nets. When an interface is referenced as a port, the variables and nets in it are assumed to have **ref** and **inout** access, respectively. The following interface example shows the basic syntax for defining, instantiating and connecting an interface. Usage of the SystemVerilog interface capability can significantly reduce the amount of code required to model port connections.

LRM 176

```

interface simple_bus; // Define the interface
    logic req, gnt;
    logic [7:0] addr, data;
    logic [1:0] mode;
    logic start, rdy;
endinterface: simple_bus

module memMod(simple_bus a, // Access the simple_bus interface
             input bit clk);
    logic avail;
    // When memMod is instantiated in module top, a.req is the req
    // signal in the sb_intf instance of the 'simple_bus' interface
    always @(posedge clk) a.gnt <= a.req & avail;
endmodule

module cpuMod(simple_bus b, input bit clk);
    ...
endmodule

module top;
    logic clk = 0;

    simple_bus sb_intf(); // Instantiate the interface

    memMod mem(sb_intf, clk); // Connect the interface to the module instance
    cpuMod cpu(.b(sb_intf), .clk(clk)); // Either by position or by name

endmodule

```

In the preceding example, if the same identifier, `sb_intf`, had been used to name the `simple_bus` interface in the `memMod` and `cpuMod` module headers, then implicit port declarations also could have been used to instantiate the `memMod` and `cpuMod` modules into the `top` module, as shown below.

```

module memMod (simple_bus sb_intf, input bit clk);

```

```

...
endmodule

module cpuMod (simple_bus sb_intf, input bit clk);
...
endmodule

module top;
  logic clk = 0;

  simple_bus sb_intf();

  memMod mem (.*); // implicit port connections
  cpuMod cpu (.*); // implicit port connections

endmodule

```

19.2.3 Interface example using a generic bundle

A module header can be created with an unspecified interface reference as a place-holder for an interface to be selected when the module itself is instantiated. The unspecified interface is referred to as a “generic” interface reference. LRM 176

This generic interface reference can only be declared by using the list of port declaration style **port-declaration style** of reference. It shall be illegal to declare such a generic interface reference using the old Verilog-1995 list of port style. LRM 220

The following interface example shows how to specify a generic interface reference in a module definition.

```

// memMod and cpuMod can use any interface
module memMod (interface a, input bit clk);
...
endmodule

module cpuMod(interface b, input bit clk);
...
endmodule

interface simple_bus; // Define the interface
  logic req, gnt;
  logic [7:0] addr, data;
  logic [1:0] mode;
  logic start, rdy;
endinterface: simple_bus

module top;
  logic clk = 0;

  simple_bus sb_intf(); // Instantiate the interface

  // Reference the sb_intf instance of the simple_bus
  // interface from the generic interfaces of the
  // memMod and cpuMod modules
  memMod mem (.a(sb_intf), .clk(clk));
  cpuMod cpu (.b(sb_intf), .clk(clk));

endmodule

```

An implicit port cannot be used to reference a generic interface. A named port must be used to reference a

generic interface, as shown below.

```

module memMod (interface a, input bit clk);
    ...
endmodule

module cpuMod (interface b, input bit clk);
    ...
endmodule

module top;
    logic clk = 0;

    simple_bus sb_intf();

    memMod mem (.*, .a(sb_intf)); // partial implicit port connections
    cpuMod cpu (.*, .b(sb_intf)); // partial implicit port connections

endmodule

```

19.3 Ports in interfaces

One limitation of simple interfaces is that the nets and variables declared within the interface are only used to connect to a port with the same nets and variables. To share an external net or variable, one that makes a connection from outside of the interface as well as forming a common connection to all module ports that instantiate the interface, an interface port declaration is required. The difference between nets or variables in the interface port list and other nets or variables within the interface is that only those in the port list can be connected externally by name or position when the interface is instantiated.

```

interface i1 (input a, output b, inout c);
    wire d;
endinterface

```

The wires a, b and c can be individually connected to the interface and thus shared with other interfaces.

The following example shows how to specify an interface with inputs, allowing a wire to be shared between two instances of the interface.

```

interface simple_bus (input bit clk); // Define the interface
    logic req, gnt;
    logic [7:0] addr, data;
    logic [1:0] mode;
    logic start, rdy;
endinterface: simple_bus

module memMod(simple_bus a); // Uses just the interface
    logic avail;

    always @(posedge a.clk) // the clk signal from the interface
        a.gnt <= a.req & avail; // a.req is in the 'simple_bus' interface
endmodule

module cpuMod(simple_bus b);
    ...
endmodule

module top;
    logic clk = 0;

```

```

    simple_bus sb_intf1(clk); // Instantiate the interface
    simple_bus sb_intf2(clk); // Instantiate the interface

    memMod mem1(.a(sb_intf1)); // Reference simple_bus 1 to memory 1
    cpuMod cpu1(.b(sb_intf1));
    memMod mem2(.a(sb_intf2)); // Reference simple_bus 2 to memory 2
    cpuMod cpu2(.b(sb_intf2));

    endmodule

```

LRM 176

Note: Because the instantiated interface names do not match the interface names used in the memMod and cpuMod modules, implicit port connections cannot be used for this example.

19.4 Modports

To restrict interface access within a module, there are **modport** lists with directions declared within the interface. The keyword **modport** indicates that the directions are declared as if inside the module.

LRM 176

```

interface i2;
    wire a, b, c, d;
    modport master (input a, b, output c, d);
    modport slave (output a, b, input c, d);
endinterface

```

In this example, the **modport** list name (master or slave) can be specified in the module header, where the interface name selects an interface and the **modport** name selects the appropriate directional information for the interface signals accessed in the module header.

```

module m (i2.master i);
    ...
endmodule

module s (i2.slave i);
    ...
endmodule

module top;
    i2 i();

    m u1(.i(i));
    s u2(.i(i));
endmodule

```

The syntax of `interface_name.modport_name reference_name` gives a local name for a hierarchical reference. Note that this can be generalized to any interface with a given **modport** name by writing `interface.modport_name reference_name`.

The **modport** list name (master or slave) can also be specified in the port connection with the module instance, where the **modport** name is hierarchical from the interface instance.

```

module m (i2 i);
    ...
endmodule

module s (i2 i);
    ...
endmodule

```

```

module top;
    i2 i();

    m u1(.i(i.master));
    s u2(.i(i.slave));
endmodule

```

In a hierarchically nested interface, the directions in a **modport** declaration can themselves be **modport** plus name.

LRM 176

```

interface i1;
    interface i3;
        wire a, b, c, d;
        modport master (input a, b, output c, d);
        modport slave (output a, b, input c, d);
    endinterface
    i3 ch1(), ch2();
    modport master2 (ch1.master, ch2.master);
endinterface

```

All of the names used in a **modport** declaration shall be declared by the same interface as is the modport itself. In particular, the names used shall not be those declared by another enclosing interface, and a modport declaration shall not implicitly declare new ports. No hierarchical references shall be permitted within a modport.

The following interface declarations would be illegal:

```

interface i;
    wire x, y;

    interface illegal_i;
        wire a, b, c, d;
        // x, y not declared by this interface
        modport master(input a, b, x, output c, d, y);
        modport slave(input a, b, x, output c, d, y);
    endinterface : illegal_i

```

```

    illegal_i ch1(), ch2();
    modport master2 (ch1.master, ch2.master);
endinterface : i

```

LRM 220

```

interface illegal_i;
    // a, b, c, d not declared by this interface
    modport master(input a, b, output c, d);
    modport slave(output a, b, output c, d);
endinterface : illegal_i

```

Note that if no **modport** is specified in the module header or in the port connection, then all the nets and variables in the interface are accessible with direction **inout** or **ref**, as in the examples above.

19.4.1 An example of a named port bundle

This interface example shows how to use modports to control signal directions as in port declarations. It uses the modport name in the module definition.

```

interface simple_bus (input bit clk); // Define the interface
    logic req, gnt;
    logic [7:0] addr, data;
    logic [1:0] mode;

```

```

    logic start, rdy;

    modport slave (input req, addr, mode, start, clk,
                  output gnt, rdy,
                  ref data);

    modport master(input gnt, rdy, clk,
                  output req, addr, mode, start,
                  ref data);

endinterface: simple_bus

module memMod (simple_bus.slave a); // interface name and modport name
    logic avail;

    always @(posedge a.clk) // the clk signal from the interface
        a.gnt <= a.req & avail; // the gnt and req signal in the interface
endmodule

module cpuMod (simple_bus.master b);
    ...
endmodule

module top;
    logic clk = 0;

    simple_bus sb_intf(clk); // Instantiate the interface

    initial repeat repeat(10) #10 clk++;

    memMod mem(.a(sb_intf)); // Connect the interface to the module instance
    cpuMod cpu(.b(sb_intf));
endmodule

```

LRM 220

19.4.2 An example of connecting a port bundle

This interface example shows how to use modports to restrict interface signal access and control their direction. It uses the modport name in the module instantiation.

LRM 176

```

interface simple_bus (input bit clk); // Define the interface
    logic req, gnt;
    logic [7:0] addr, data;
    logic [1:0] mode;
    logic start, rdy;

    modport slave (input req, addr, mode, start, clk,
                  output gnt, rdy,
                  ref data);

    modport master(input gnt, rdy, clk,
                  output req, addr, mode, start,
                  ref data);

endinterface: simple_bus

module memMod(simple_bus a); // Uses just the interface name
    logic avail;

```

```

    always @(posedge a.clk) // the clk signal from the interface
        a.gnt <= a.req & avail; // the gnt and req signal in the interface
endmodule

module cpuMod(simple_bus b);
    ...
endmodule

module top;
    logic clk = 0;

    simple_bus sb_intf(clk); // Instantiate the interface

    initial repeat(10) #10 clk++;

    memMod mem(sb_intf.slave); // Connect the modport to the module instance
    cpuMod cpu(sb_intf.master);
endmodule

```

19.4.3 An example of connecting a port bundle to a generic interface

This interface example shows how to use modports to control signal directions. It shows the use of the interface keyword in the module definition. The actual interface and modport are specified in the module instantiation.

```

interface simple_bus (input bit clk); // Define the interface
    logic req, gnt;
    logic [7:0] addr, data;
    logic [1:0] mode;
    logic start, rdy;

    modport slave (input req, addr, mode, start, clk,
                  output gnt, rdy,
                  ref data);

    modport master(input gnt, rdy, clk,
                  output req, addr, mode, start,
                  ref data);

endinterface: simple_bus

module memMod(interface a); // Uses just the interface
    logic avail;

    always @(posedge a.clk) // the clk signal from the interface
        a.gnt <= a.req & avail; // the gnt and req signal in the interface
endmodule

module cpuMod(interface b);
    ...
endmodule

module top;
    logic clk = 0;

    simple_bus sb_intf(clk); // Instantiate the interface

    memMod mem(sb_intf.slave); // Connect the modport to the module instance
    cpuMod cpu(sb_intf.master);

```

```
endmodule
```

19.4.4 Modport expressions

LRM 32

A modport expression allows elements of arrays and structures, concatenations of elements, aggregate expressions of elements declared in an interface to be included in a modport list. This modport expression is explicitly named with a port identifier, visible only through the modport connection.

Like explicitly named ports in a module port declaration, port identifiers exist in their own namespace for each modport list. When modport item is just a simple port identifier, that identifier is used as both a reference to an interface item and a port identifier. Once a port identifier has been defined, there shall not be another port definition with this same name.

For example:

```
interface I;
  logic [7:0] r;
  const int x=1;
  bit R;
  modport A (output .P(r[3:0]), input .Q(x), R);
  modport B (output .P(r[7:4]), input .Q(2), R);
endinterface

module M ( interface i);,
  initial i.P = i.Q;
endmodule

module top;
  I i1;
  M u1 (i1.A);
  M u2 (i1.B);
  initial #1 $display("%b", i1.r); // displays 00010010
endmodule
```

The self-determined type of the port expression becomes the type for the port. If the port expression is to be an aggregate expression, then a cast must be used since self-determined aggregate expressions are not allowed. The **port-expression** **port expression** must resolve to a legal expression for type of module port (See section 18.12—Port connection rules). In the example above, the Q port could not be an output or inout because the port expression is a constant. The port expression is optional because ports can be defined that do not connect to anything internal to the port.

LRM 243

19.4.5 Clocking blocks and modports

LRM 107

The **modport** construct can also be used to specify the direction of clocking blocks declared within an interface. As with other **modport** declarations, the directions of the clocking block are those seen from the module in which the interface becomes a port. The syntax for this is shown below.

```
modport_declaration ::= modport modport_item { , modport_item } ; //from Annex A.2.9
modport_item ::= modport_identifier ( modport_ports_declaration { , modport_ports_declaration } )
modport_ports_declaration ::=
  { attribute_instance } modport_simple_ports_declaration
  | { attribute_instance } modport_hierarchical_ports_declaration
  | { attribute_instance } modport_tf_ports_declaration
  | { attribute_instance } modport_clocking_declaration
modport_clocking_declaration ::= clocking clocking_identifier
```

Syntax 19-2—modport clocking declaration syntax (excerpt from Annex A)

All of the **clocking** blocks used in a **modport** declaration shall be declared by the same interface as is the modport itself. Like all **modport** declarations, the direction of the clocking signals are those seen from the module in which the interface becomes a port. The example below shows how modports can be used to create both synchronous as well as asynchronous ports. When used in conjunction with virtual interfaces (see Section 19.8.2), these constructs facilitate the creation of abstract synchronous models.

```

interface A_Bus( input bit clk );
    wire req, gnt;
    wire [7:0] addr, data;

    clocking sb @(posedge clk);
        input gnt;
        output req, addr;
        inout data;

    property p1; req ##[1:3] gnt; endproperty
endclocking

modport DUT ( input clk, req, addr,    // Device under test modport
              output gnt,
              inout data );

modport STB ( clocking sb );          // synchronous testbench modport

modport TB ( input gnt,                // asynchronous testbench modport
             output req, addr,
             inout data );
endinterface

```

The above interface A_Bus can then be instantiated as shown below:

```

module dev1(A_Bus.DUT b);    // Some device: Part of the design
    ...
endmodule

module dev2(A_Bus.DUT b);    // Some device: Part of the design
    ...
endmodule

module top;
    bit clk;

    A_Bus b1( clk );
    A_Bus b2( clk );

    dev1 d1( b1 );
    dev2 d2( b2 );

    T tb( b1, b2 );
endmodule

program T (A_Bus.STB b1, A_Bus.STB b2 ); // Testbench: 2 synchronous ports

    assert property (b1.p1);        // assert property from within program

    initial begin
        b1.sb.req <= 1;

```

```

        wait( b1.sb.gnt == 1 );
        ...
        b1.sb.req <= 0;
        b2.sb.req <= 1;
        wait( b2.sb.gnt == 1 );
        ...
        b2.sb.req <= 0;
    end
endprogram

```

The example above shows the program block using the synchronous interface designated by the clocking-modport of interface ports b1 and b2. In addition to the procedural drives and samples of the clocking block signals, the program asserts the property p1 of one of its interfaces b1.

19.5 Interfaces and specify blocks

LRM 6

The **specify** block is used to describe various paths across a module and perform timing checks to ensure that events occurring at the module inputs satisfy the timing constraints of the device described by the module. The module paths are from module input ports to output ports and the timing checks are relative to the module inputs. The specify block refers to these ports as terminal descriptor. Module **inout** ports can function as either an input or output terminal. When one of the port instances is an interface, each signal in the interface becomes an available terminal, with the default direction as defined for an interface, or as restricted by a modport. A **ref** port cannot be used as a terminal in a specify block.

The following shows an example of using interfaces together with a specify block:

```

interface itf;
    logic c,q,d;
    modport flop (input c,d, output q);
endinterface

module dtype (itf.flop ch);
    always_ff @(posedge ch.c) ch.q <= ch.d;

    specify
        (posedge ch.c => (ch.q+:ch.d)) = (5,6);
        $setup( ch.d, posedge ch.c, 1 );
    endspecify
endmodule

```

19.6 Tasks and functions in interfaces

Tasks and functions can be defined within an interface, or they can be defined within one or more of the modules connected. This allows a more abstract level of modeling. For example “read” and “write” can be defined as tasks, without reference to any wires, and the master module can merely call these tasks. In a **modport** these tasks are declared as **import** tasks.

If a module is connected to a modport containing an exported task or function, and the module does not define that task or function, then an elaboration error shall occur. Similarly if the modport contains an exported task or function prototype, and the task or function defined in the module does not exactly match that prototype, then an elaboration error shall occur.

If the tasks or functions are defined in a module, using a hierarchical name, they must also be declared as **extern** in the interface, or as **export** in a **modport**.

Tasks (not functions) can be defined in a module that is instantiated twice, e.g. two memories driven from the same CPU. Such multiple task definitions are allowed by a **forkjoin extern** declaration in the interface.

19.6.1 An example of using tasks in an interface

```
interface simple_bus (input bit clk); // Define the interface
    logic req, gnt;
    logic [7:0] addr, data;
    logic [1:0] mode;
    logic start, rdy;

    task masterRead(input logic [7:0] raddr); // masterRead method
        // ...
    endtask: masterRead

    task slaveRead; // slaveRead method
        // ...
    endtask: slaveRead

endinterface: simple_bus

module memMod(interface a); // Uses any interface
    logic avail;

    always @(posedge a.clk) // the clk signal from the interface
        a.gnt <= a.req & avail // the gnt and req signals in the interface

    always @(a.start)
        a.slaveRead;
endmodule

module cpuMod(interface b);
    enum {read, write} instr;
    logic [7:0] raddr;

    always @(posedge b.clk)
        if (instr == read)
            b.masterRead(raddr); // call the Interface method
        ...
endmodule

module top;
    logic clk = 0;

    simple_bus sb_intf(clk); // Instantiate the interface

    memMod mem(sb_intf);
    cpuMod cpu(sb_intf);
endmodule
```

A function prototype specifies the types and directions of the arguments and the return value of a function which is defined elsewhere. Similarly, a task prototype specifies the types and directions of the arguments of a task which is defined elsewhere. In a modport, the import and export constructs can either use task or function prototypes or use just the identifiers. The only exception is when a modport is used to import a function or task from another module, in which case a full prototype shall be used.

The number and types of arguments in a prototype must match the argument types in the function or task declaration. The rules for type equivalency are described in Section 5.8.1, Equivalent types.

LRM 111

19.6.2 An example of using tasks in modports

This interface example shows how to use modports to control signal directions and task access in a full read/

write interface.

```

interface simple_bus (input bit clk); // Define the interface
  logic req, gnt;
  logic [7:0] addr, data;
  logic [1:0] mode;
  logic start, rdy;

  modport slave (input req, addr, mode, start, clk,
                output gnt, rdy,
                ref data,
                import task slaveRead(),
                    task slaveWrite());
    // import into module that uses the modport

  modport master(input gnt, rdy, clk,
                output req, addr, mode, start,
                ref data,
                import masterRead,
                    masterWrite);
    // import into module that uses the modport

  task masterRead(input logic [7:0] raddr); // masterRead method
    // ...
  endtask

  task slaveRead; // slaveRead method
    // ...
  endtask

  task masterWrite(input logic [7:0] waddr);
    //...
  endtask

  task slaveWrite;
    //...
  endtask

endinterface: simple_bus

module memMod(interface a); // Uses just the interface
  logic avail;

  always @(posedge a.clk) // the clk signal from the interface
    a.gnt <= a.req & avail; // the gnt and req signals in the interface

  always @(a.start)
    if (a.mode[0] == 1'b0)
      a.slaveRead;
    else
      a.slaveWrite;
endmodule

module cpuMod(interface b);
  enum {read, write} instr = $rand();
  logic [7:0] raddr = $rand();

  always @(posedge b.clk)
    if (instr == read)

```

```

        b.masterRead(raddr); // call the Interface method
    // ...
    else
        b.masterWrite(raddr);
endmodule

module omniMod( interface b);
    //...
endmodule: omniMod

module top;
    logic clk = 0;

    simple_bus sb_intf(clk); // Instantiate the interface

    memMod mem(sb_intf.slave); // only has access to the slave tasks
    cpuMod cpu(sb_intf.master); // only has access to the master tasks
    omniMod omni(sb_intf); // has access to all master and slave tasks
endmodule

```

19.6.3 An example of exporting tasks and functions

This interface example shows how to define tasks in one module and call them in another, using modports to control task access.

```

interface simple_bus (input bit clk); // Define the interface
    logic req, gnt;
    logic [7:0] addr, data;
    logic [1:0] mode;
    logic start, rdy;

    modport slave( input req, addr, mode, start, clk,
                  output gnt, rdy,
                  ref data,
                  export task Read(),
                  task Write());
    // export from module that uses the modport

    modport master(input gnt, rdy, clk,
                  output req, addr, mode, start,
                  ref data,
                  import task Read(input logic [7:0] raddr),
                  task Write(input logic [7:0] waddr));
    // import requires the full task prototype

endinterface: simple_bus

module memMod(interface a); // Uses just the interface keyword
    logic avail;

    task a.Read; // Read method
        avail = 0;
        ...
        avail = 1;
    endtask

    task a.Write;
        avail = 0;
        ...

```

```

        avail = 1;
    endtask
endmodule

module cpuMod(interface b);
    enum {read, write} instr;
    logic [7:0] raddr;

    always @(posedge b.clk)
        if (instr == read)
            b.Read(raddr); // call the slave method via the interface
            ...
        else
            b.Write(raddr);
endmodule

module top;
    logic clk = 0;

    simple_bus sb_intf(clk); // Instantiate the interface

    memMod mem(sb_intf.slave); // exports the Read and Write tasks
    cpuMod cpu(sb_intf.master); // imports the Read and Write tasks
endmodule

```

19.6.4 An example of multiple task exports

It is normally an error for more than one module to export the same task name. However, several instances of the same modport type can be connected to an interface, such as memory modules in the previous example. So that these can still export their read and write tasks, the tasks must be declared in the interface using the **extern forkjoin** keywords.

The call to `extern forkjoin task countslaves()`; in the example below behaves as:

```

fork
    top.mem1.a.countslaves;
    top.mem2.a.countslaves;
join

```

For a read task, only one module should actively respond to the task call, e.g. the one containing the appropriate address. The tasks in the other modules should return with no effect. Only then should the active task write to the result variables.

Note multiple export of functions is not allowed, because they must always write to the result.

The effect of a **disable** on an **extern forkjoin** task is as follows:

- If the task is referenced via the interface instance, all task calls shall be disabled.
- If the task is referenced via the module instance, only the task call to that module instance shall be disabled.
- If an interface contains an **extern forkjoin** task, and no module connected to that interface defines the task, then any call to that task shall report a run-time error and return immediately with no effect.

This interface example shows how to define tasks in more than one module and call them in another using **extern forkjoin**. The multiple task export mechanism can also be used to count the instances of a particular modport that are connected to each interface instance.

```

interface simple_bus (input bit clk); // Define the interface

```

```

logic req, gnt;
logic [7:0] addr, data;
logic [1:0] mode;
logic start, rdy;
int slaves = 0;

// tasks executed concurrently as a fork/join block
extern forkjoin task countSlaves();
extern forkjoin task Read (input logic [7:0] raddr);
extern forkjoin task Write (input logic [7:0] waddr);

modport slave (input req,addr, mode, start, clk,
               output gnt, rdy,
               ref data, slaves,
               export Read, Write, countSlaves);
// export from module that uses the modport

modport master ( input gnt, rdy, clk,
                 output req, addr, mode, start,
                 ref data,
                 import task Read(input logic [7:0] raddr),
                 task Write(input logic [7:0] waddr));
// import requires the full task prototype

initial begin
  slaves = 0;
  countSlaves;
  $display ("number of slaves = %d", slaves);
end

endinterface: simple_bus

module memMod #(parameter int minaddr=0, maxaddr=0;) (interface a);
  logic avail = 1;
  logic [7:0] mem[255:0];

  task a.countSlaves();
    a.slaves++;
  endtask

  task a.Read(input logic [7:0] raddr); // Read method
    if (raddr >= minaddr && raddr <= maxaddr) begin
      avail = 0;
      #10 a.data = mem[raddr];
      avail = 1;
    end
  endtask

  task a.Write(input logic [7:0] waddr); // Write method
    if (waddr >= minaddr && waddr <= maxaddr) begin
      avail = 0;
      #10 mem[waddr] = a.data;
      avail = 1;
    end
  endtask
endmodule

module cpuMod(interface b);
  typedef enum {read, write} instr;

```

```

instr inst;
logic [7:0] raddr;
integer seed;

always @(posedge b.clk) begin
    inst = instr'($dist_uniform(seed, 0, 1));
    raddr = $dist_uniform(seed, 0, 3);
    if (inst == read) begin
        $display("%t begin read %h @ %h", $time, b.data, raddr);
        callr:b.Read(raddr);
        $display("%t end read %h @ %h", $time, b.data, raddr);
    end
    else begin
        $display("%t begin write %h @ %h", $time, b.data, raddr);
        b.data = raddr;
        callw:b.Write(raddr);
        $display("%t end write %h @ %h", $time, b.data, raddr);
    end
end
endmodule

module top;
    logic clk = 0;

    function void interrupt();
        disable mem1.a.Read; // task via module instance
        disable sb_intf.Write; // task via interface instance
        if (mem1.avail == 0) $display ("mem1 was interrupted");
        if (mem2.avail == 0) $display ("mem2 was interrupted");
    endfunction

    always #5 clk++;

    initial begin
        #28 interrupt();
        #10 interrupt();
        #100 $finish;
    end

    simple_bus sb_intf(clk);

    memMod #(0, 127) mem1(sb_intf.slave);
    memMod #(128, 255) mem2(sb_intf.slave);
    cpuMod cpu(sb_intf.master);
endmodule

```

19.7 Parameterized interfaces

Interface definitions can take advantage of parameters and parameter redefinition, in the same manner as module definitions. This example shows how to use parameters in interface definitions.

```

interface simple_bus #(AWIDTH = 8, DWIDTH = 8)
    (input bit clk); // Define the interface

    logic req, gnt;
    logic [AWIDTH-1:0] addr;
    logic [DWIDTH-1:0] data;
    logic [1:0] mode;
    logic start, rdy;

```

LRM 86

```

modport slave(input req, addr, mode, start, clk,
              output gnt, rdy,
              ref data,
              import task slaveRead(),
                  task slaveWrite());
    // import into module that uses the modport

modport master(input gnt, rdy, clk,
               output req, addr, mode, start,
               ref data,
               import task masterRead(input logic [AWIDTH-1:0] raddr),
                   task masterWrite(input logic [AWIDTH-1:0] waddr));
    // import requires the full task prototype

task masterRead(input logic [AWIDTH-1:0] raddr); // masterRead method
    ...
endtask

task slaveRead; // slaveRead method
    ...
endtask

task masterWrite(input logic [AWIDTH-1:0] waddr);
    ...
endtask

task slaveWrite;
    ...
endtask

endinterface: simple_bus

module memMod(interface a); // Uses just the interface keyword
    logic avail;

    always @(posedge a.clk) // the clk signal from the interface
        a.gnt <= a.req & avail; //the gnt and req signals in the interface

    always @(a.start)
        if (a.mode[0] == 1'b0)
            a.slaveRead;
        else
            a.slaveWrite;
endmodule

module cpuMod(interface b);
    enum {read, write} instr;
    logic [7:0] raddr;

    always @(posedge b.clk)
        if (instr == read)
            b.masterRead(raddr); // call the Interface method
            // ...
        else
            b.masterWrite(raddr);
endmodule

module top;

```

LRM 84

```

logic clk = 0;

simple_bus sb_intf(clk); // Instantiate default interface
simple_bus #(DWIDTH(16)) wide_intf(clk); // Interface with 16-bit data

initial repeat(10) #10 clk++;

memMod mem(sb_intf.slave); // only has access to the slaveRead task
cpuMod cpu(sb_intf.master); // only has access to the masterRead task

memMod memW(wide_intf.slave); // 16-bit wide memory
cpuMod cpuW(wide_intf.master); // 16-bit wide cpu
endmodule

```

19.8 Virtual interfaces

LRM 72
LRM 74

Virtual interfaces provide a mechanism for separating abstract models and test programs from the actual signals that make up the design. A virtual interface allows the same subprogram to operate on different portions of a design, and to dynamically control the set of signals associated with the subprogram. Instead of referring to the actual set of signals directly, users are able to manipulate a set of virtual signals. Changes to the underlying design do not require the code using virtual interfaces to be re-written. By abstracting the connectivity and functionality of a set of blocks, virtual interfaces promote code-reuse.

A virtual interface is a variable that represents an interface instance. The syntax to declare a virtual interface variable is given below.

virtual_interface_declaration ::=	// from Annex A.2.9
virtual [interface] interface_identifier list_of_virtual_interface_decl ;	
list_of_virtual_interface_decl ::=	// from Annex A.2.3
variable_identifier [= interface_instance_identifier]	
{ , variable_identifier [= interface_instance_identifier] }	
data_declaration ¹⁶ ::=	// from Annex A.2.1.3
...	
virtual_interface_declaration	
data_type_common_item data_type ::=	// from Annex A.2.2.1
...	
virtual [interface] interface_identifier	

LRM 249

Syntax 19-3—virtual interface declaration syntax (excerpt from Annex A)

Virtual interface variables can be passed as arguments to tasks, functions, or methods. A single virtual interface variable can thus represent different interface instances at different times throughout the simulation. A virtual interface must be initialized before it can be used; it has the value `null` before it is initialized. Attempting to use an uninitialized virtual interface shall result in a fatal run-time error.

Only the following operations are directly allowed on virtual interface variables:

- Assignment (=) to:
 - another virtual interface of the same type
 - an interface instance of the same type
 - the special constant `null`

- Equality (==) and inequality (!=) with:
 - another virtual interface of the same type
 - an interface instance of the same type
 - the special constant **null**

Virtual interfaces shall not be used as ports, interface items, or as members of unions.

Once a virtual interface has been initialized, all the components of the underlying interface instance are directly available to the virtual interface via the dot notation. These components can only be used in procedural statements; they cannot be used in continuous assignments or sensitivity lists. In order for a net to be driven via a virtual interface, the interface itself must provide a procedural means to do so. This can be accomplished either via a clocking block or by including a driver that is updated by a continuous assignment from a variable within the interface.

LRM 137

Virtual interfaces can be declared as class properties, which can be initialized procedurally or by an argument to **new()**. This allows the same virtual interface to be used in different classes. The following example shows how the same transactor class can be used to interact with various different devices.

```

interface SBus;                                // A Simple bus interface
    logic req, grant;
    logic [7:0] addr, data;
endinterface

class SBusTransactor;                          // SBus transactor class
    virtual SBus bus;                           // virtual interface of type Sbus

    function new( virtual SBus s );           // initialize the virtual interface
        bus = s;
    endfunction

    task request();                             // request the bus
        bus.req <= 1'b1;
    endtask

    task wait_for_bus();                       // wait for the bus to be granted
        @(posedge bus.grant);
    endtask
endclass

module devA( Sbus s ) ... endmodule           // devices that use SBus
module devB( Sbus s ) ... endmodule

module top;

    SBus s[1:4] ();                             // instantiate 4 interfaces

    devA a1( s[1] );                             // instantiate 4 devices
    devB b1( s[2] );
    devA a2( s[3] );
    devB b2( s[4] );

    initial begin
        SbusTransactor t[1:4];                 // create 4 bus-transactors and bind

        t[1] = new( s[1] );
        t[2] = new( s[2] );
    end

```

```

        t[3] = new( s[3] );
        t[4] = new( s[4] );
        // test t[1:4]
    end
endmodule

```

In the preceding example, the transaction class `SbusTransactor` is a simple reusable component. It is written without any global or hierarchical references, and is unaware of the particular device with which it will interact. Nevertheless, the class can interact with any number of devices (4 in the example) that adhere to the interface's protocol.

19.8.1 Virtual interfaces and clocking blocks

LRM 137

Clocking blocks and interfaces can be combined to represent the interconnect between synchronous blocks. Moreover, because clocking blocks provide a procedural mechanism to assign values to both nets and variables, they are ideally suited to be used by virtual interfaces. For example:

```

interface SyncBus( input bit clk );
    wire a, b, c;

    clocking sb @(posedge clk);
        input a;
        output b;
        inout c;
    endclocking

endinterface

typedef virtual SyncBus VI;          // A virtual interface type

task do_it( VI v );                  // handles any SyncBus via clocking sb
    if( v.sb.a == 1 )
        v.sb.b <= 0;
    else
        v.sb.c <= ##1 1;
endtask

```

In the preceding example, interface `SyncBus` includes a clocking block, which is used by task `do_it` to ensure synchronous access to the interface's signals: `a`, `b`, and `c`. Note that changes to the storage type of the interface signals (from net to variable and vice-versa) requires no changes to the task. The interfaces can be instantiated as shown below.

LRM 137

```

module top;
    bit clk;

    SyncBus b1( clk );
    SyncBus b2( clk );

    initial begin
        VI v[2] = { b1, b2 };

        repeat( 20 )
            do_it( v[ $urandom_range( 0, 1 ) ] );
    end
endmodule

```

The top module above shows how a virtual interface can be used to randomly select among a set of interfaces to be manipulated, in this case by the `do_it` task.

19.8.2 Virtual interfaces modports and clocking blocks

As shown in the example above, once a virtual interface is declared, its clocking block can be referenced using dot-notation. However, this only works for interfaces with no modports. Typically, a device under test and its testbench exhibit modport direction. This common case can be handled by including the clocking in the corresponding modport as described in Section 19.4.5.

The example below shows how modports used in conjunction with virtual interfaces facilitate the creation of abstract synchronous models.

```
interface A_Bus( input bit clk );
  wire req, gnt;
  wire [7:0] addr, data;

  clocking sb @(posedge clk);
    input gnt;
    output req, addr;
    inout data;

    property p1; req ##[1:3] gnt; endproperty
endclocking

modport DUT ( input clk, req, addr,    // Device under test modport
              output gnt,
              inout data );

modport STB ( clocking sb );          // synchronous testbench modport

modport TB ( input gnt,               // asynchronous testbench modport
             output req, addr,
             inout data );
endinterface
```

The above interface `A_Bus` can then be instantiated as shown below:

```
module dev1(A_Bus.DUT b);              // Some device: Part of the design
  ...
endmodule

module dev2(A_Bus.DUT b);              // Some device: Part of the design
  ...
endmodule

program T (A_Bus.STB b1, A_Bus.STB b2 ); // Testbench: 2 synchronous ports
  ...
endprogram

module top;
  bit clk;

  A_Bus b1( clk );
  A_Bus b2( clk );

  dev1 d1( b1 );
  dev2 d2( b2 );

  T tb( b1, b2 );
endmodule
```

And, within the testbench program, the virtual interface can refer directly to the clocking block.

LRM 137

```

program T (A_Bus.STB b1, A_Bus.STB b2 ); // Testbench: 2 synchronous ports

    typedef virtual A_Bus.STB SYNCTB;

    task request( SYNCTB s );
        s.sb.req <= 1;
    endtask

    task wait_grant( SYNCTB s );
        wait( s.sb.gnt == 1 );
    endtask

    task drive(SYNCTB s, logic [7:0] adr, data );
        if( s.sb.gnt == 0 ) begin
            request(s); // acquire bus if needed
            wait_grant(s);
        end
        s.sb.addr = adr;
        s.sb.data = data;
        repeat repeat(2) @s.sb;
        s.sb.req = 0; //release bus
    endtask

    assert property (b1.p1); // assert property from within program

    initial begin
        drive( b1, $random, $random );
        drive( b2, $random, $random );
    end
endprogram

```

LRM 242

The example above shows how the clocking block is referenced via the virtual interface by the tasks within the program block.

LRM 137

19.9 Access to interface objects

Access to all objects declared in an interface is always available by hierarchical reference, regardless of whether or not the interface is connected through a port. When an interface is connected with a modport in either the module header or port connection, access by port reference is limited to only those objects listed in the modport, for only those types of objects legal to be listed in modports (nets, variables, tasks, and functions) All objects are still visible by hierarchical reference. For example:

LRM 85

```

interface ebus_i;
    integer I; // reference to I not allowed through modport mp
    typedef enum {Y,N} choice;
    choice Q;
    parameter True = 1;
    modport mp(input Q);
endinterface

module Top;
    ebus_i ebus;
    sub s1(ebus.mod);
endmodule

module sub(interface.mp i);

```

```
typedef i.choice yes_no; // import type from interface
yes_no P;
assign P = i.Q; // refer to Q with a port reference
initial
    Top.s1.Q = i.True; // refer to Q with a hierarchical reference
initial
    Top.s1.I = 0; // referring to i.I would not be legal because
                // is not in modport mp
endmodule
```

Section 20 Coverage

LRM 61 LRM 65 LRM 71

20.1 Introduction (informative)

Functional verification comprises a large portion of the resources required to design and validate a complex system. Often, the validation must be comprehensive without redundant effort. To minimize wasted effort, coverage is used as a guide for directing verification resources by identifying tested and untested portions of the design.

Coverage is defined as the percentage of verification objectives that have been met. It is used as a metric for evaluating the progress of a verification project in order to reduce the number of simulation cycles spent in verifying a design

Broadly speaking, there are two types of coverage metrics. Those that can be automatically extracted from the design code, such as code coverage, and those that are user-specified in order to tie the verification environment to the design intent or functionality. This latter form is referred to as Functional Coverage, and is the topic of this section.

Functional coverage is a user-defined metric that measures how much of the design specification, as enumerated by features in the test plan, has been exercised. It can be used to measure whether interesting scenarios, corner cases, specification invariants, or other applicable design conditions—captured as features of the test plan—have been observed, validated and tested.

The key aspects of functional coverage are:

- It is user-specified, and is not automatically inferred from the design
- It is based on the design specification (i.e., its intent) and is thus independent of the actual design code or its structure.

Since it is fully specified by the user, functional coverage requires more up front effort (someone has to write the coverage model). Functional coverage also requires a more structured approach to verification. Although functional coverage can shorten the overall verification effort and yield higher quality designs, these shortcomings can impede its adoption.

The SystemVerilog functional coverage extensions address these shortcomings by providing language constructs for easy specification of functional coverage models. This specification can be efficiently executed by the SystemVerilog simulation engine, thus, enabling coverage data manipulation and analysis tools that speed up the development of high quality tests. The improved set of tests can exercise more corner cases and required scenarios, without redundant work.

The SystemVerilog functional coverage constructs enable:

- Coverage of variables and expressions, as well as cross coverage between them.
- Automatic as well as user-defined coverage bins.
- Associate bins with sets of values, transitions, or cross products.
- Filtering conditions at multiple levels.
- Events and sequences to automatically trigger coverage sampling.
- Procedural activation and query of coverage.
- Optional directives to control and regulate coverage.

20.2 Defining the coverage model: covergroup

The **covergroup** construct encapsulates the specification of a coverage model. Each covergroup specification can include the following components:

- A clocking event that synchronizes the sampling of coverage points
- A set of coverage points
- Cross coverage between coverage points
- Optional formal arguments
- Coverage options

The **covergroup** construct is a user-defined type. The type definition is written once, and multiple instances of that type can be created in different contexts. Similar to a class, once defined, a **covergroup** instance can be created via the **new()** operator. A **covergroup** can be defined in a module, program, interface, or class.

```

covergroup_declaration ::=                                     //from Annex A.2.11
    covergroup covergroup_identifier [ ( list_of_tf_proto_formals [ tf_port_list ] ) ] [ coverage_event
    ] ;
        { coverage_spec_or_option ; }
    endgroup [ : covergroup_identifier ]
coverage_spec_or_option ::=
    { attribute_instance } coverage_spec
    | { attribute_instance } coverage_option ;
coverage_option ::=
    option.member_identifier = expression
    | type_option.member_identifier = expression
coverage_spec ::=
    cover_point
    | cover_cross
coverage_event ::=
    clocking_identifier
    | @@ ( block_event_expression )
block_event_expression ::=
    block_event_expression or block_event_expression
    | begin hierarchical_btf_identifier
    | end hierarchical_btf_identifier
hierarchical_btf_identifier ::=
    hierarchical_tf_identifier
    | hierarchical_block_identifier
    | hierarchical_identifier † [ class_scope † ] † method_identifier
variable_decl_assignment ::=                                 //from Annex A.2.4
    ...
    [ covergroup_variable_identifier ] = new [ ( list_of_arguments ) ]17

```

LRM 229
LRM 243
LRM 249

LRM 127

LRM 173

17. It shall be legal to omit the `covergroup_variable_identifier` from a `covergroup` instantiation only if this implicit instantiation is within a class that has no other instantiation of the `covergroup`.

Syntax 20-1—Covergroup syntax (excerpt from Annex A)

The identifier associated with the **covergroup** declaration defines the name of the coverage model. Using this

name, an arbitrary number of coverage model instances can be created. For example:

```
covergroup cg; ... endgroup
cg cg_inst = new;
```

The above example defines a **covergroup** named `cg`. An instance of `cg` is declared as `cg_inst` and created using the **new** operator.

A **covergroup** can specify an optional list of arguments. When the **covergroup** specifies a list of formal arguments, its instances must provide to the **new** operator all the actual arguments that are not defaulted. Actual arguments are evaluated when the **new** operator is executed. A **ref** argument allows a different variable to be sampled by each instance of a **covergroup**. Input arguments will not track value of their arguments; they will use the value passed to the **new** operator.

If a clocking event is specified, it defines the event at which coverage points are sampled. If the clocking event is omitted, users must procedurally trigger the coverage sampling. This is done via the built-in `sample()` method (see Section 20.7). Optionally, the **strobe** option can be used to modify the sampling behavior. When the strobe option is not set (the default), a coverage point is sampled the instant the clocking event takes place, as if the process triggering the event were to call the built-in `sample()` method. If the clocking event occurs multiple times in a time step, the coverage point will also be sampled multiple times. The strobe option (see Section 20.6.1) can be used to specify that coverage points are sampled in the postponed region, thereby filtering multiple clocking events so that only **one** sample per time slot is taken.

LRM 127

LRM 127

LRM 259

LRM 127

As an alternative to a clocking event, a coverage group accepts a block event expression to indicate that the coverage sample is to be triggered by the start or the end of execution of a given named block, task, function, or class method. Block event expressions that specify the **begin** keyword followed by a hierarchical identifier denoting a named block, task, function, or class method shall be triggered immediately before the corresponding block, task, function, or method begins executing its first statement. Block event expressions that specify the **end** keyword followed by a hierarchical identifier denoting a named block, task, function, or class method shall be triggered immediately after the corresponding block, task, function, or method executes its last statement. Block event expressions that specify the end of execution shall not be triggered if the block, task, function, or method is disabled.

A **covergroup** can contain one or more coverage points. A coverage point can be a variable or an expression. Each coverage point includes a set of bins associated with its sampled values or its value-transitions. The bins can be explicitly defined by the user or automatically created by the tool. Coverage points are discussed in detail in Section 20.4.

```
enum { red, green, blue } color;

covergroup g1 @(posedge clk);
  c: coverpoint color;
endgroup
```

The above example defines coverage group `g1` with a single coverage point associated with variable `color`. The value of the variable `color` is sampled at the indicated clocking event: the positive edge of signal `clk`. Since the coverage point does not explicitly define any bins, the tool automatically creates 3 bins, one for each possible value of the enumerated type. Automatic bins are described in Section 20.4.2.

A coverage group can also specify cross coverage between two or more coverage points or variables. Any combination of more than two variables or previously declared coverage points is allowed. For example:

```
enum { red, green, blue } color;
bit [3:0] pixel_adr, pixel_offset, pixel_hue;

covergroup g2 @(posedge clk);
  Hue:    coverpoint pixel_hue;
  Offset: coverpoint pixel_offset;
```

```

    AxC: cross color, pixel_adr;    // cross 2 variables (implicitly declared
                                   // coverpoints)
    all: cross color, Hue, Offset; // cross 1 variable and 2 coverpoints
endgroup

```

The example above creates coverage group `g2` that includes 2 coverage points and two cross coverage items. Explicit coverage points labeled `Offset` and `Hue` are defined for variables `pixel_offset` and `pixel_hue`. SystemVerilog implicitly declares coverage points for variables `color` and `pixel_adr` in order to track their cross coverage. Implicitly declared cover points are described in Section 20.5.

A coverage group can also specify one or more options to control and regulate how coverage data is structured and collected. Coverage options can be specified for the coverage group as a whole, or for specific items within the coverage group, that is, any of its coverage points or crosses. In general, a coverage option specified at the `covergroup` level applies to all of its items unless overridden by them. Coverage options are described in Section 20.6.

20.3 Using covergroup in classes

By embedding a coverage group within a class definition, the `covergroup` provides a simple way to cover a subset of the class properties. This integration of coverage with classes provides an intuitive and expressive mechanism for defining the coverage model associated with a class. For example,

In class `xyz`, defined below, members `m_x` and `m_y` are covered using an embedded `covergroup`:

```

class xyz;
    bit [3:0] m_x;
    int m_y;
    bit m_z;

    covergroup cov1 @m_z;           // embedded covergroup
        coverpoint m_x;
        coverpoint m_y;
    endgroup

    function new(); cov1 = new; endfunction
endclass

```

In this example, data members `m_x` and `m_y` of class `xyz` are sampled on every change of data member `m_z`.

When a `covergroup` is defined within a class, and no explicit variables of that `covergroup` are declared in the class then a variable with the same name as the coverage group is implicitly declared, e.g, in the above example, a variable `cov1` (of the embedded coverage group) is implicitly declared. Whether the coverage group variable is implicitly or explicitly declared, each class contains exactly one variable of each embedded coverage group. Each embedded coverage group thus becomes part of the class, tightly binding the class properties to the coverage definition. Declaring multiple variables of the same embedded coverage group shall result in a compiler error.

An embedded `covergroup` can define a coverage model for protected and local class properties without any changes to the class data encapsulation. Class members can become coverage points or can be used in other coverage constructs, such as conditional guards or option initialization.

A class can have more than one `covergroup`. The following example shows two cover groups in class `MC`.

```

class MC;
    logic [3:0] m_x;
    local logic m_z;
    bit m_e;
    covergroup cv1 @(posedge clk); coverpoint m_x; endgroup

```

```

    covergroup cv2 @m_e ; coverpoint m_z; endgroup
endclass

```

In **covergroup** cv1, public class member variable `m_x` is sampled at every positive edge of signal `clk`. Local class member `m_z` is covered by another **covergroup** cv2. Each coverage group is sampled by a different clocking event.

An embedded coverage group must be explicitly instantiated in the **new** method. If it is not, then the coverage group is not created and no data will be sampled.

Below is an example of an embedded coverage_group that does not have any passed-in arguments, and uses explicit instantiation to synchronize with another object:

```

class Helper;
    int m_ev;
endclass

class MyClass;
    Helper m_obj;
    int m_a;
    covergroup Cov @(m_obj.m_ev);
        coverpoint m_a;
    endgroup

    function new();
        m_obj = new;

        Cov = new;    // Create embedded covergroup after creating m_obj
    endfunction
endclass

```

In this example, **covergroup** Cov is embedded within class MyClass, which contains an object of type Helper class, called `m_obj`. The clocking event for the embedded coverage group refers to data member `m_ev` of `m_obj`. Because the coverage group Cov uses `m_obj`, `m_obj` must be instantiated before Cov. Therefore, the coverage group Cov is instantiated after instantiating `m_obj` in the class constructor. As shown above, the instantiation of an embedded coverage group is done by assigning the result of the **new** operator to the coverage group identifier.

The following example shows how arguments passed in to an embedded coverage group can be used to set a coverage option of the coverage group.

```

class C1;
    bit [7:0] x;

    covergroup cv (int arg) @(posedge clk);
        option.at_least = arg;
        coverpoint x;
    endgroup

    function new(int p1);
        cv = new(p1);
    endfunction
endclass

initial begin
    C1 obj = new(4);
end

```

20.4 Defining coverage points

A **covergroup** can contain one or more coverage points. A coverage point can be an integral variable or an integral expression. Each coverage point includes a set of bins associated with its sampled values or its value-transitions. The bins can be explicitly defined by the user or automatically created by SystemVerilog. The syntax for specifying coverage points is given below.

```

cover_point ::=                                     //from Annex A.2.11
    [ cover_point_identifier : ] coverpoint expression [ iff ( expression ) ] bins_or_empty
bins_or_empty ::=
    { {attribute_instance} { bins_or_options ; } }
    | ;
bins_or_options ::=
    coverage_option
    | [ wildcard ] bins_keyword bin_identifier [ [ [ expression ] ] = { range_list } [ iff ( expression ) ]
    | [ wildcard ] bins_keyword bin_identifier [ [ ] ] = ( trans_list ) [ iff ( expression ) ]
    | bins_keyword bin_identifier [ [ [ expression ] ] ] = default [ iff ( expression ) ]
    | bins_keyword bin_identifier = default sequence [ iff ( expression ) ]
bins_keyword ::= bins | illegal_bins | ignore_bins
range_list ::= value_range { , value_range }
value_range ::=                                     //from Annex A.8.3
    expression
    | [ expression : expression ]

```

LRM 251
LRM 256

Syntax 20-2—coverpoint syntax (excerpt from Annex A)

A coverage point creates a hierarchical scope, and can be optionally labeled. If the label is specified then it designates the name of the coverage point. This name can be used to add this coverage point to a cross coverage specification, or to access the methods of the coverage point. If the label is omitted and the coverage point is associated with a single variable then the variable name becomes the name of the coverage point. Otherwise, an implementation can generate a name for the coverage point only for the purposes of coverage reporting, that is, generated names cannot be used within the language.

A coverage point can sample the values that correspond to a particular scheduling region (see Section 14) by specifying a clocking block signal. Thus, a coverage point that denotes a clocking block signal will sample the values made available by the clocking block. If the clocking block specifies a skew of **#1step**, the coverage point will sample the signal values from the Preponed region. If the clocking block specifies a skew of **#0**, the coverage point will sample the signal values from the Observe region.

The expression within the **iff** construct specifies an optional condition that disables coverage for that cover point. If the guard expression evaluates to false at a sampling point, the coverage point is ignored. For example:

```

covergroup g4;
    coverpoint s0 iff(!reset);
endgroup

```

In the preceding example, cover point **s0** is covered only if the value **reset** is false.

A coverage-point bin associates a name and a count with a set of values or a sequence of value transitions. If the bin designates a set of values, the count is incremented every time the coverage point matches one of the values in the set. If the bin designates a sequence of value transitions, the count is incremented every time the coverage point matches the entire sequence of value transitions.

The bins for a coverage point can be automatically created by SystemVerilog or explicitly defined using the `bins` construct to name each bin. If the bins are not explicitly defined, they are automatically created by SystemVerilog. The number of automatically created bins can be controlled using the `auto_bin_max` coverage option. Coverage options are described in Section 20.6.

The `bins` construct allows creating a separate bin for each value in the given range-list, or a single bin for the entire range of values. To create a separate bin for each value (an array of bins) the square brackets, `[]`, must follow the bin name. To create a fixed number of bins for a set of values, a number can be specified inside the square brackets. The `range_list` used to specify the set of values associated with a bin shall be constant expressions, instance constants (for classes only) or non-`ref` arguments to the coverage group.

If a fixed number of bins is specified, and that number is smaller than the number of values in the bin then the possible bin values are uniformly distributed among the specified bins. If the number of values is not divisible by the number of bins then the last bin will include the remaining items. For example:

```
bins fixed [3] = {1:10};
```

The 11 possible values are distributed as follows: `<1,2,3>`, `<4,5,6>`, `<7,8,9,10>`. If the number of bins exceeds the number of values then some of the bins will be empty.

The expression within the `iff` construct at the end of a bin definition provides a per-bin guard condition. If the expression is false at a sampling point, the count for the bin is not incremented.

The `default` specification defines a bin that is associated with none of the defined value bins. The `default` bin catches the values of the coverage point that do not lie within any of the defined bins. However, the coverage calculation for a coverage point shall not take into account the coverage captured by the default bin. The default is useful for catching unplanned or invalid values. The `default sequence` form can be used to catch all transitions (or sequences) that do not lie within any of the defined transition bins (see Section 20.4.1). The `default sequence` specification does not accept multiple transition bins (the `[]` notation is not allowed).

```
int bit [9:0] v_a;

covergroup cg @(posedge clk);

    coverpoint v_a
    {
        bins a = { [0:63], 65 };
        bins b[] = { [127:150], [148:191] }; // note overlapping values
        bins c[] = { 200, 201, 202 };
        bins d = { [1000:$] };
        bins others[] = default;
    }
endgroup
```

LRM 274

In the example above, the first `bins` construct associates bin `a` with the values of variable `v_a` between 0 and 63, and the value 65. The second `bins` construct creates a set of 65 bins `b[127]`, `b[128]`, ... `b[191]`. Likewise, the `last third bins` construct creates 3 bins: `c[200]`, `c[201]`, and `c[202]`. The `fourth bins` construct associates bin `d` with the values between 1000 and 1023 (`$` represents the maximum value of `v_a`). Every value that does not match bins `a`, `b[]`, `c[]`, or `d[]` is added into its own distinct bin.

A `default` or `default sequence` bin specification cannot be explicitly ignored (see Section 20.4.4). It shall be an error for bins designated as `ignore_bins` to also specify a `default` or `default sequence`.

Generic coverage groups can be written by passing their traits as arguments to the constructor. For example:

```
covergroup gc (ref int ra, int low, int high) @(posedge clk);

    coverpoint ra // sample variable passed by reference
    {
```

```

        bins good = { [low : high] };
        bins bad[] = default;
    }
endgroup

...
int va, vb;

cg c1 = new( va, 0, 50 ); // cover variable va in the range 0 to 50
cg c2 = new( vb, 120, 600 ); // cover variable vb in the range 120 to 600

```

The example above defines a coverage group, `gc`, in which the signal to be sampled as well as the extent of the coverage bins are specified as arguments. Later, two instances of the coverage group are created; each instance samples a different signal and covers a different range of values.

20.4.1 Specifying bins for transitions

The syntax for specifying transition bins accepts a subset of the sequence syntax described in Section 17:

<pre> bins_or_options ::= ... [wildcard] bins_keyword bin_identifier [[[expression]] = { range_list } [iff (expression)] [wildcard] bins_keyword bin_identifier [[]] = (trans_list) [iff (expression)] ... bins_keyword ::= bins illegal_bins ignore_bins range_list ::= value_range { , value_range } trans_list ::= (trans_set) { , (trans_set) } trans_set ::= trans_range_list => trans_range_list { => trans_range_list } trans_range_list ::= trans_item trans_item [[* repeat_range]] trans_item [[* -> [-> repeat_range]]] trans_item [[* = [= repeat_range]]] trans_item ::= { range_list } + value_range repeat_range ::= expression expression : expression </pre>	<p><i>//from Annex A.2.11</i></p> <p>LRM 251 LRM 253 LRM 267</p>
--	--

Syntax 20-3—Transition bin syntax (excerpt from Annex A)

A *trans_list* specifies one or more sets of ordered value transitions of the coverage point. A single value transition is thus specified as:

```
value1 => value2
```

It represents the value of coverage point at two successive sample points, that is, `value1` followed by `value2` at the next sample point.

A sequence of transitions is represented as:

```
value1 => value3 => value4 => value5
```

In this case, `value1` is followed by `value3`, followed by `value4` and followed by `value5`. A sequence can be of any arbitrary length.

SystemVerilog 3.1a/draft 5

A set of transitions can be specified as:

```
{range_list1} => {range_list2}
```

LRM 251

This specification expands to transitions between each value in `range_list1` and each value in `range_list2`. For example,

```
{1, 5} => {6, 7}
```

specifies the following four transitions:

```
1=>6, 1=>7, 5=>6, 5=>7
```

Consecutive repetitions of transitions are specified using (see Annex H):

```
trans_item [* repeat_range ]
```

Here, `trans_item` is repeated for `repeat_range` times. For example,

```
3 [* 5]
```

is the same as

LRM 229

```
3=>3=>3=>3=>3=>3
```

An example of a range of repetition is:

```
3 [* 3:5]
```

is the same as

```
3=>3=>3, 3=>3=>3=>3, 3=>3=>3=>3=>3
```

The repetition with non-consecutive occurrence of a value is specified using: `trans_item [*-> repeat_range]`. Here, the occurrence of a value is specified with an arbitrary number of sample points where the value does not occur. For example,

LRM 209
LRM 267

```
3 [*-> 3]
```

is the same as

```
...3=>...=>3...=>3
```

where the dots (...) represent any transition that does not contain the value 3.

Non-consecutive repetition is where a sequence of transitions continues until the next transition. For example,

```
3 [*= 2]
```

is same as the transitions below excluding the last transition.

```
3=>...=>3...=>3
```

A `trans_list` specifies one or more sets of ordered value transitions of the coverage point. If the sequence of value transitions of the coverage point matches any complete sequence in the `trans_list`, the coverage count of the corresponding bin is incremented. For example:

```
bit [4:1] v_a;

covergroup cg @(posedge clk);
```



```

coverpoint v_a
{
  bins sa = (4 => 5 => 6), ({[7:9], 10} => {11, 12});
  bins sb[] = (4 => 5 => 6), ({[7:9], 10} => {11, 12});
  bins allother = default sequence ;
}
endgroup

```

LRM 251

LRM 274

The example above defines two transition coverage bins. The first **bins** construct associates the following sequences with bin *sa*: 4=>5=>6, or 7=>11, 8=>11, 9=>11, 10=>11, 7=>12, 8=>12, 9=>12, 10=>12. The second **bins** construct associates an individual bin with each of the above sequences: *sb*[4=>5=>6], ..., *sb*[10=>12]. The bin *allother* tracks all other transitions that are not covered by the other bins: *sa* and *sb*.

LRM 274

Transitions that specify sequences of unbounded or undetermined varying length cannot be used with the multiple bins construct (the [] notation). For example, the length of the transition: 3 [*=2], which uses non-consecutive repetition, is unbounded and can vary during simulation. An attempt to specify multiple bins with such sequences shall result in an error.

LRM 209
LRM 267

20.4.2 Automatic bin creation for coverage points

If a coverage point does not define any bins, SystemVerilog automatically creates state bins. This provides an easy-to-use mechanism for binning different values of a coverage point. Users can either let the tool automatically create state bins for coverage points or explicitly define named bins for each coverage point.

When the automatic bin creation mechanism is used, SystemVerilog creates *N* bins to collect the sampled values of a coverage point. The value *N* is determined as follows:

- For an **enum** coverage point, *N* is the cardinality of the enumeration.
- For any other integral coverage point, *N* is the minimum of 2^M and the value of the `auto_bin_max` option, where *M* is the number of bits needed to represent the coverage point.

If the number of automatic bins is smaller than the number of possible values ($N < 2^M$) then the 2^M values are uniformly distributed in the *N* bins. If the number of values, 2^M , is not divisible by *N*, then the last bin will include the additional (up to *N*-1) remaining items. For example, if *M* is 3, and *N* is 3 then the 8 possible values are distributed as follows: <0:1>, <2:3>, <4,5,6,7>.

Automatically created bins only consider 2-state values; sampled values containing **x** or **z** are excluded.

SystemVerilog implementations can impose a limit on the number of automatic bins. See the Section 20.6 for the default value of `auto_bin_max`.

Each automatically created bin will have a name of the form: `auto[value]`, where *value* is either a single coverage point value, or the range of coverage point values included in the bin—in the form *low:high*. For enumerated types, *value* is the named constant associated with a particular enumerated value.

LRM 185

20.4.3 Wildcard specification of coverage point bins

By default, a value or transition bin definition can specify 4-state values. When a bin definition includes an **x** or **z**, it indicates that the bin count should only be incremented when the sampled value has an **x** or **z** in the same bit positions, i.e., the comparison is done using `===`. The **wildcard bins** definition causes all **x**, **z**, or **?** to be treated as wildcards for 0 or 1 (similar to the `==?` operator). For example:

```
wildcard bins g12_16 = { 4'b11?? };
```

The count of bin `g12_16` is incremented when the sampled variable is between 12 and 16:

```
1100    1101    1110    1111
```

Similarly, transition bins can define **wildcard bins**. For example:

```
wildcard bins T0_3 = (2'b0x => 2'b1x);
```

The count of transition bin T0_3 is incremented for the following transitions (as if by (~~{0,1}~~=>~~{2,3}~~)): LRM 251

```
00 => 10    00 => 11    01 => 10    01 => 11
```

A wildcard bin definition only consider 2-state values; sampled values containing **x** or **z** are excluded. Thus, the range of values covered by a wildcard bin is established by replacing every wildcard digit by 0 to compute the low bound and 1 to compute the high bound.

20.4.4 Excluding coverage point values or transitions

A set of values or transitions associated with a coverage-point can be explicitly excluded from coverage by specifying them as **ignore_bins**. For example:

```
covergroup cg23;
  coverpoint a
  {
    ignore_bins ignore_vals = {7,8};
    ignore_bins ignore_trans = (1=>3=>5);
  }
endgroup
```

All values or transitions associated with ignored bins are excluded from coverage. Ignored values or transitions are excluded even if they are also included in another bin.

20.4.5 Specifying Illegal coverage point values or transitions

A set of values or transitions associated with a coverage-point can be marked as illegal by specifying them as **illegal_bins**. For example:

```
covergroup cg3;
  coverpoint b
  {
    illegal_bins bad_vals = {1,2,3};
    illegal_bins bad_trans = (4=>5=>6);
  }
endgroup
```

All values or transitions associated with illegal bins are excluded from coverage. If they occur, a run-time error is issued. Illegal bins take precedence over any other bins, that is, they will result in a run-time error even if they are also included in another bin.

20.5 Defining cross coverage

A coverage group can specify cross coverage between two or more coverage points or variables. Cross coverage is specified using the **cross** construct. When a variable V is part of a cross coverage, SystemVerilog implicitly creates a coverage point for the variable, as if it had been created by the statement `coverpoint V;`. Thus, a cross involves only coverage points. Expressions cannot be used directly in a cross; a coverage point must be explicitly defined first.

The syntax for specifying cross coverage is given below.

```

cover_cross ::=                                     //from Annex A.2.11
    [cover_point_identifier : ] cross cross list_of_coverpoints [ iff ( expression ) ]
    select_bins_or_empty
list_of_coverpoints ::= cross_item , cross_item { , cross_item }
cross_item ::=
    cover_point_identifier
    | variable_identifier
select_bins_or_empty ::=
    { { bins_selections_or_option ; } }
    | ;
bins_selection_or_option ::=
    { attribute_instance } coverage_option
    | { attribute_instance } bins_selection
bins_selection ::= bins_keyword bin_identifier = select_expression [ iff ( expression ) ]
select_expression ::=
    select_condition
    | !select_condition
    | select_expression && select_expression
    | select_expression || select_expression
    | ( select_expression )
select_condition ::= binsof ( bins_expression ) [ intersect open_range_list ]
bins_expression ::=
    variable_identifier
    | cover_point_identifier [ . bins_identifier ]
open_range_list ::= { open_value_range { , open_value_range } }
open_value_range ::= value_range22

```

Syntax 20-4—Cross coverage syntax (excerpt from Annex A)

The label for a **cross** declaration provides an optional name. The label also creates a hierarchical scope for the **bins** defined within the **cross**.

The expression within the optional **iff** provides a conditional guard for the cross coverage. If at any sample point, the condition evaluates to false, the cross coverage is ignored. **The expression within the optional iff construct at the end of a cross bin definition provides a per-bin guard condition. If the expression is false, the cross bin is ignored.**

Cross coverage of a set of N coverage points is defined as the coverage of all combinations of all bins associated with the N coverage points, that is, the Cartesian product of the N sets of coverage-point bins. For example:

```

bit [3:0] a, b;

covergroup cov @(posedge clk);
    aXb : cross a, b;
endgroup

```

The coverage group cov in the example above specifies the cross coverage of two 4-bit variables, a and b. SystemVerilog implicitly creates a coverage point for each variable. Each coverage point has 16 bins, namely auto[0]...auto[15]. The cross of a and b (labeled aXb), therefore, has 256 cross products, and each cross product is a bin of aXb.

Cross coverage between expressions previously defined as coverage points is also allowed. For example:

```

bit [3:0] a, b, c;

covergroup cov2 @(posedge clk);
  BC: coverpoint b+c;
  aXb : cross a, BC;
endgroup

```

The coverage group `cov2` has the same number of cross products as the previous example, but in this case, one of the coverage points is the expression `b+c`, which is labeled `BC`.

```

bit [31:0] a_var;
bit [3:0] b_var;

covergroup cov3 @(posedge clk);
  A: coverpoint a_var { bins yy[] = { [0:9] }; }
  CC: cross b_var, A;
endgroup

```

The coverage group `cov3` crosses variable `b_var` with coverage point `A` (labeled `CC`). Variable `b_var` automatically creates 16 bins (`auto[0] ... auto[15]`). Coverage point `A` explicitly creates 10 bins `yy[0] ... yy[9]`. The cross of two coverage points creates $16 * 10 = 160$ cross product bins, namely the pairs shown below:

```

<auto[0], yy[0]>
<auto[0], yy[1]>
...
<auto[0], yy[9]>
<auto[1], yy[0]>
...
<auto[15], yy[9]>

```

Cross coverage is allowed only between coverage points defined within the same coverage group. Coverage points defined in a coverage group other than the one enclosing the cross cannot participate in a cross. Attempts to cross items from different coverage groups shall result in a compiler error.

In addition to specifying the coverage points that are crossed, SystemVerilog includes a powerful set of operators that allow defining cross coverage bins. Cross coverage bins can be specified in order to group together a set of cross products. A cross-coverage bin associates a name and a count with a set of cross products. The count of the bin is incremented every time any of the cross products match, i.e., every coverage point in the cross matches its corresponding bin in the cross product.

User-defined bins for cross coverage are defined using bins select-expressions. The syntax for defining these bin selection expressions is given in Syntax 20-4.

The `binsof` construct yields the bins of its expression, which can be either a coverage point (explicitly defined or implicitly defined for a single variable) or a coverage-point bin. The resulting bins can be further selected by including (or excluding) only the bins whose associated values intersect a desired set of values. The desired set of values can be specified using a comma-separated list of `open_value_range` as shown in Syntax 20-4. For example, the following select expression:

```

binsof( x ) intersect { y }

```

denotes the bins of coverage point `x` whose values intersect the range given by `y`. Its negated form:

```

! binsof( x ) intersect { y }

```

denotes the bins of coverage point `x` whose values do not intersect the range given by `y`.

The `open_value_range` syntax can specify a single value, a range of values, or an open range, which denotes the following:

```
[ $ : value ] => The set of values less than or equal to value  
[ value : $ ] => The set of values greater or equal to value
```

The bins selected can be combined with other selected bins using the logical operators **&&** and **||**.

20.5.1 Example of user-defined cross coverage and select expressions

```
bit [7:0] v_a, v_b;  
  
covergroup cg @(posedge clk);  
  
  a: coverpoint v_a  
  {  
    bins a1 = { [0:63] };  
    bins a2 = { [64:127] };  
    bins a3 = { [128:191] };  
    bins a4 = { [192:255] };  
  }  
  
  b: coverpoint v_b  
  {  
    bins b1 = {0};  
    bins b2 = { [1:84] };  
    bins b3 = { [85:169] };  
    bins b4 = { [170:255] };  
  }  
  
  c : cross v_a, v_b  
  {  
    bins c1 = ! binsof(a) intersect { [100:200] }; // 4 cross products  
    bins c2 = binsof(a.a2) || binsof(b.b2); // 7 cross products  
    bins c3 = binsof(a.a1) && binsof(b.b4); // 1 cross product  
  }  
endgroup
```

The example above defines a coverage-group named `cg` that samples its cover-points on the positive edge of signal `clk` (not shown). The coverage-group includes two cover-points, one for each of the two 8-bit variables, `v_a` and `v_b`. The coverage-point labeled ‘a’ associated with variable `v_a`, defines four equal-sized bins for each possible value of variable `v_a`. Likewise, the coverage-point labeled ‘b’ associated with variable `v_b`, defines four bins for each possible value of variable `v_b`. The cross definition labeled ‘c’, specifies the cross coverage of the two cover-points `v_a` and `v_b`. If the cross coverage of cover-points a and b were defined without any additional cross-bins (select expressions), then cross coverage of a and b would include 16 cross products corresponding to all combinations of bins a1 through a4 with bins b1 through b4, that is, cross products `<a1, b1>`, `<a1,b2>`, `<a1,b3>`, `<a1,b4>`... `<a4, b1>`, `<a4,b2>`, `<a4,b3>`, `<a4,b4>`.

The first user-defined cross bin, `c1`, specifies that `c1` should include only cross products of cover-point a that do not intersect the value range 100-200. This select expression excludes bins a2, a3, and a4. Thus, `c1` will cover only four cross-products of `<a1,b1>`, `<a1,b2>`, `<a1,b3>`, and `<a1,b4>`.

The second user-defined cross bin, `c2`, specifies that bin `c2` should include only cross products whose values are covered by bin a2 of cover-point a or cross products whose values are covered by bin b2 of cover-point b. This select expression includes the following 7 cross products: `<a2, b1>`, `<a2,b2>`, `<a2,b3>`, `<a2,b4>`, `<a1, b2>`, `<a3,b2>`, and `<a4,b2>`.

The final user-defined cross bin, `c3`, specifies that `c3` should include only cross products whose values are cov-

ered by bin a1 of cover-point a and cross products whose values are covered by bin b4 of cover-point b. This select expression includes only one cross-product <a1, b4>.

When select expressions are specified on transition bins, the `binsof` operator uses the last value of the transition.

20.5.2 Excluding cross products

A group of bins can be excluded from coverage by specifying a select expression using `ignore_bins`. For example:

```
covergroup yy;
  cross a, b
  {
    ignore_bins foo = binsof(a) intersect { 5, [1:3] };
  }
endgroup
```

All cross products that satisfy the select expression are excluded from coverage. Ignored cross products are excluded even if they are included in other cross-coverage bins of the enclosing cross.

20.5.3 Specifying Illegal cross products

A group of bins can be marked as illegal by specifying a select expression using `illegal_bins`. For example:

```
covergroup zz(int bad);
  cross x, y
  {
    illegal_bins foo = binsof(y) intersect {bad};
  }
endgroup
```

All cross products that satisfy the select expression are excluded from coverage, and a run-time error is issued. Illegal cross products take precedence over any other cross products, that is, they will result in a run-time error even if they are also explicitly ignored (using an `ignore_bins`) or included in another cross bin.

20.6 Specifying coverage options

Options control the behavior of the `covergroup`, `coverpoint` and `cross`. There are two types of options: those that are specific to an instance of a `covergroup`, and those that specify an option for the `covergroup` type as a whole.

The following table lists instance specific `covergroup` options and their description. Each instance of a `covergroup` can initialize an instance specific option to a different value. The initialized option value affects only that instance.

Table 20-1: Instance specific coverage options

Option name	Default	Description
<code>weight= number</code>	1	If set at the <code>covergroup</code> syntactic level, it specifies the weight of this <code>covergroup</code> instance for computing the overall instance coverage of the simulation. If set at the <code>coverpoint</code> (or <code>cross</code>) syntactic level, it specifies the weight of a <code>coverpoint</code> (or <code>cross</code>) for computing the instance coverage of the enclosing <code>covergroup</code> .

Table 20-1: Instance specific coverage options (continued)

goal=number	90	Specifies the target goal for a covergroup instance, or a coverpoint or a cross of an instance.
name=string	unique name	Specify a name for the covergroup instance. If unspecified, a unique name for each instance is automatically generated by the tool.
comment=string	""	A comment that appears with the instance of a covergroup , or a coverpoint or cross of the covergroup instance. The comment is saved in the coverage database and included in the coverage report.
at_least=number	1	Minimum number of hits for each bin. A bin with a hit count that is less than <i>number</i> is not considered covered.
detect_overlap=boolean	0	When true, a warning is issued if there is an overlap between the range list (or transition list) of two bins of a coverpoint .
auto_bin_max=number	64	Maximum number of automatically created bins when no bins are explicitly defined for a coverpoint .
cross_auto_bin_max=number	unbounded	Maximum number of automatically created cross product bins for a cross .
cross_num_print_missing=number	0	Number of missing (not covered) cross product bins that must be saved to the coverage database and printed in the coverage report.
per_instance=boolean	0	Each instance contributes to the overall coverage information for the covergroup type. When true, coverage information for this covergroup instance is tracked as well.

The instance specific options mentioned above can be set in the **covergroup** definition. The syntax for setting these options in the **covergroup** definition is:

```
option.option_name = expression ;
```

The identifier **option** is a built-in member of any coverage group (see Section 20.9 for a description).

An example is shown below.

```
covergroup g1 (int int w, string instComment) @(posedge clk) ;
    // track coverage information for each instance of g1 in addition
    // to the cumulative coverage information for covergroup type g1
    option.per_instance = 1;

    // comment for each instance of this covergroup
    option.comment = instComment;

    a : coverpoint a_var
    {
        // Create 128 automatic bins for coverpoint "a" of each instance of g1
        option.auto_bin_max = 128;
    }
    b : coverpoint b_var
    {
        // This coverpoint contributes w times as much to the coverage of an
        // instance of g1 than coverpoints "a" and "c1"
        option.weight = w;
    }
    c1 : cross a_var, b_var ;
endgroup
```

LRM 242

LRM 229

Option assignment statements in the `covergroup` definition are evaluated at the time that the covergroup is instantiated. The `per_instance` option can only be set in the `covergroup` definition. Other instance specific options can be set procedurally after a covergroup has been instantiated. The syntax is:

```
coverage_option_assignment ::= // not in Annex A
    instance_name.option.option_name = expression ;
    | instance_name.covergroup_item_identifier.option.option_name = expression ;
```

Syntax 20-5—Coverage option assignment syntax (not in Annex A)

LRM 229

Here is an example:

```
covergroup gc @(posedge clk) ;
    a : coverpoint a_var;
    b : coverpoint b_var;
endgroup
...
gc g1 = new;
g1.option.comment = "Here is a comment set for the instance g1";
g1.a.option.weight = 3; // Set weight for coverpoint "a" of instance g1
```

The following table summarizes the syntactical level (`covergroup`, `coverpoint`, or `cross`) at which instance options can be specified. All instance options can be specified at the covergroup level. Except for the `weight`, `goal`, `comment`, and `per_instance` options, all other options set at the covergroup syntactic level act as a default value for the corresponding option of all coverpoints and crosses in the covergroup. Individual coverpoint or crosses can overwrite these default values. When set at the covergroup level, the `weight`, `goal`, `comment`, and `per_instance` options do not act as default values to the lower syntactic levels.

Table 20-2: Coverage options per-syntactic level

Option name	Allowed in Syntactic Level		
	covergroup	coverpoint	cross
name	Yes	No	No
weight	Yes	Yes	Yes
goal	Yes	Yes	Yes
comment	Yes	Yes	Yes
at_least	Yes (default for coverpoints & crosses)	Yes	Yes
detect_overlap	Yes (default for coverpoints)	Yes	No
auto_bin_max	Yes (default for coverpoints)	Yes	No
cross_auto_bin_max	Yes (default for crosses)	No	Yes
cross_num_print_missing	Yes (default for crosses)	No	Yes
per_instance	Yes	No	No

20.6.1 Covergroup Type Options

The following table lists options that describe a particular feature (or property) of the `covergroup` type as a whole. They are analogous to static data members of classes.

Table 20-3: Coverage group type (static) options

Option name	Default	Description
<code>weight=constant_number</code>	1	If set at the <code>covergroup</code> syntactic level, it specifies the weight of this <code>covergroup</code> for computing the overall cumulative (or type) coverage of the saved database. If set at the <code>coverpoint</code> (or <code>cross</code>) syntactic level, it specifies the weight of a <code>coverpoint</code> (or <code>cross</code>) for computing the cumulative (or type) coverage of the enclosing <code>covergroup</code> .
<code>goal=constant_number</code>	90	Specifies the target goal for a <code>covergroup</code> type, or a <code>coverpoint</code> or <code>cross</code> of a <code>covergroup</code> type.
<code>comment=string_literal</code>	""	A comment that appears with the <code>covergroup</code> type, or a <code>coverpoint</code> or <code>cross</code> of the <code>covergroup</code> type. The comment is saved in the coverage database and included in the coverage report.
<code>strobe=constant_number</code>	0	If set to 1, all samples happen at the end of the time slot, like the <code>\$strobe</code> system task.

The `covergroup` type options mentioned above can be set in the `covergroup` definition. The syntax for setting these options in the `covergroup` definition is:

```
type_option.option_name = expression ;
```

The identifier `type_option` is a built-in member of any coverage group (see Section 20.9 for a description).

Different instances of a covergroup cannot assign different values to type options. This is syntactically disallowed, since these options can only be initialized via constant expressions. Here is an example:

```
covergroup g1 (int int w, string string instComment) @(posedge clk) ;
// track coverage information for each instance of g1 in addition
// to the cumulative coverage information for covergroup type g1
option.per_instance = 1;

type_option.comment = "Coverage model for features foo and bar";

type_option.strobe = 1;    // sample at the end of the time slot

// comment for each instance of this covergroup
option.comment = instComment;

a : coverpoint a_var
{
    // Use weight 2 to compute the coverage of each instance
    option.weight = 2;
    // Use weight 3 to compute the cumulative (type) coverage for g1
    type_option.weight = 3;
    // NOTE: type_option.weight = w would cause syntax error.
}
b : coverpoint b_var
```

LRM 242

LRM 229

```

    // Use weight w to compute the coverage of each instance
    option.weight = w;
    // Use weight 5 to compute the cumulative (type) coverage of g1
    type_option.weight = 5;
}
endgroup

```

In the above example the coverage for each instance of `g1` is computed as:

$$(((\text{instance coverage of "a"}) * 2) + ((\text{instance coverage of "b"}) * w)) / (2 + w)$$

On the other hand the coverage for **covergroup** type “g1” is computed as:

$$(((\text{overall type coverage of "a"}) * 3) + ((\text{overall type coverage of "b"}) * 5)) / (3 + 5).$$

Type options can be set procedurally at any time during simulation. The syntax is:

```

coverage_type_option_assignment ::= // not in Annex A
    covergroup_name::type_option.option_name = expression ;
| covergroup_name::covergroup_item_identifier::type_option.option_name = expression ;

```

Syntax 20-6—Coverage type option assignment syntax (not in Annex A)

LRM 229

Here is an example:

```

covergroup gc @(posedge clk) ;
    a : coverpoint a_var;
    b : coverpoint b_var;
endgroup
...
gc::type_option.comment = "Here is a comment for covergroup g1";

// Set the weight for coverpoint "a" of covergroup g1
gc::a::type_option.weight = 3;
gc g1 = new;

```

The following table summarizes the syntactical level (**covergroup**, **coverpoint**, or **cross**) in which type options can be specified. When set at the **covergroup** level, the type options do not act as defaults for lower syntactic levels.

Table 20-4: Coverage type-options

Option name	Allowed Syntactic Level		
	covergroup	coverpoint	cross
weight	Yes	Yes	Yes
goal	Yes	Yes	Yes
comment	Yes	Yes	Yes
strobe	Yes	No	No

20.7 Predefined coverage methods

The following coverage methods are provided for the `covergroup`. These methods can be invoked procedurally at any time.

Table 20-5: Predefined coverage methods

Method (function)	Can be called on			Description
	covergroup	coverpoint	cross	
void sample()	Yes	No	No	Triggers sampling of the covergroup
real get_coverage()	Yes	Yes	Yes	Calculates type coverage number (0..100)
real get_inst_coverage()	Yes	Yes	Yes	Calculates the coverage number (0..100)
void set_inst_name(string)	Yes	No	No	Sets the instance name to the given string
void start()	Yes	Yes	Yes	Starts collecting coverage information
void stop()	Yes	Yes	Yes	Stops collecting coverage information
real query()	Yes	Yes	Yes	Returns the cumulative coverage information (for the coverage group type as a whole)
real inst_query()	Yes	Yes	Yes	Returns the per-instance coverage information for this instance

20.8 Predefined coverage system tasks and functions

SystemVerilog provides the following system tasks and functions to help manage coverage data collection.

\$set_coverage_db_name (name) — Sets the filename of the coverage database into which coverage information is saved at the end of a simulation run.

\$load_coverage_db (name) — Load from the given filename the cumulative coverage information for all coverage group types.

\$get_coverage () — Returns as a real number in the range 0 to 100 the overall coverage of all coverage group types. This number is computed as described above.

20.9 Organization of option and type_option members

The type and type_option members of a covergroup, coverpoint, and cross items are implicitly declared structures with the following composition:

```

struct          // covergroup option declaration
{
    string    name ;
    int       weight ;
    int       goal ;
    string    comment ;
    int       at_least ;
    int       auto_bin_max ;
    int       cross_auto_bin_max ;

```

```
    int    cross_num_print_missing ;
    bit    detect_overlap ;
    bit    per_instance ;
} option;

struct    // coverpoint option declaration
{
    int    weight ;
    int    goal ;
    string comment ;
    int    at_least ;
    int    auto_bin_max ;
    bit    detect_overlap ;
} option;

struct    // cross option declaration
{
    int    weight ;
    int    goal ;
    string comment ;
    int    at_least ;
    int    cross_auto_bin_max ;
    int    cross_num_print_missing ;
} option;

struct    // covergroup type_option declaration
{
    int    weight ;
    int    goal ;
    string comment ;
    bit    strobe ;
} type_option;

struct    // coverpoint and cross type_option declaration
{
    int    weight ;
    int    goal ;
    string comment ;
} type_option;
```

Section 21 Parameters

21.1 Introduction (informative)

Verilog-2001 provides three constructs for defining compile time constants: the **parameter**, **localparam** and **specparam** statements.

The language provides four methods for setting the value of parameter constants in a design. Each parameter must be assigned a default value when declared. The default value of a parameter of an instantiated module can be overridden in each instance of the module using one of the following:

- Implicit in-line parameter redefinition (e.g. `foo #(value, value) u1 (...);`)
- Explicit in-line parameter redefinition (e.g. `foo #(.name(value), .name(value)) u1 (...);`)
- **defparam** statements, using hierarchical path names to redefine each parameter

21.1.1 Defparam removal

The **defparam** statement might be removed from future versions of the language. See Section 26.2.

21.2 Parameter declaration syntax

```

local_parameter_declaration ::= //from Annex A.2.1.1
    localparam [ signing ] { packed_dimension } list_of_param_assignments ;
    † localparam data_type_or_implicit list_of_param_assignments ;
parameter_declaration ::=
    parameter [ signing ] { packed_dimension } list_of_param_assignments
    † parameter data_type_or_implicit list_of_param_assignments
    | parameter type list_of_type_assignments
specparam_declaration ::=
    specparam [ packed_dimension ] list_of_specparam_assignments ;
data_type_or_implicit ::= | //from Annex A.2.2.1
    data_type
    | [ signing ] { packed_dimension }
list_of_param_assignments ::= param_assignment { , param_assignment } //from Annex A.2.3
list_of_specparam_assignments ::= specparam_assignment { , specparam_assignment }
list_of_type_assignments ::= type_assignment { , type_assignment }
param_assignment ::= | // from Annex A.2.4
    parameter_identifier { unpacked_dimension } = constant_param_expression
specparam_assignment ::=
    specparam_identifier = constant_mintypmax_expression
    | pulse_control_specparam
type_assignment ::= type_identifier = data_type
parameter_port_list ::= | // from Annex A.1.4
    # ( list_of_param_assignments { , parameter_port_declaration } )
    | # ( parameter_port_declaration { , parameter_port_declaration } )
parameter_port_declaration ::=
    parameter_declaration
    | data_type list_of_param_assignments
    | type list_of_type_assignments

```

LRM 227
LRM 243LRM 45
LRM 86
LRM 90

Syntax 21-1—Parameter declaration syntax (excerpt from Annex A)

A module, interface, program or class can have parameters, which are set during elaboration and are constant during simulation. They are defined with data types and default values. With SystemVerilog, if no data type is supplied, parameters default to type `logic` of arbitrary size for Verilog-2001 compatibility and interoperability.

LRM 86

SystemVerilog adds the ability for a parameter to also specify a data type, allowing modules or instances to have data whose type is set for each instance.

```

module ma    #( parameter p1 = 1, parameter type p2 = shortint )
              (input logic [p1:0] i, output logic [p1:0] o);
    p2 j = 0; // type of j is set by a parameter, (shortint unless redefined)
    always @(i) begin
        o = i;
        j++;
    end
endmodule

```

LRM 3

```

module mb;
  logic [3:0] i,o;
  ma #(.p1(3), .p2(int)) u1(i,o); //redefines p2 to a type of int
endmodule

```

SystemVerilog adds the ability for local parameters to be declared in a generate block. Local parameters can also be declared in a package or in a compilation unit scope. In these contexts, the **parameter** keyword can be used as a synonym for the **localparam** keyword. LRM 161

\$ can be assigned to parameters of integer types. A parameter to which \$ is assigned shall only be used wherever \$ can be specified as a literal constant. LRM 135

For example, \$ represents unbounded range specification, where the upper index can be any integer.

```

parameter r2 = $;
property inq1(r1,r2);
  @(posedge clk) a ##[r1:r2] b ##1 c | => d;
endproperty
assert inq1(3);

```

LRM 154

To support whether a constant is \$, a system function is provided to test whether a constant is a \$. The syntax of the system function is

```
$isunbounded(const_expression);
```

\$isunbounded returns true if *const_expression* is unbounded. Typically, \$isunbounded would be used as a condition in the **generate** statement.

The example below illustrates the benefit of using \$ in writing properties concisely where the range is parameterized. The checker in the example ensures that a bus driven by signal en remains 0, i.e, quiet for the specified minimum (*min_quiet*) and maximum (*max_quiet*) quiet time.

Note that function \$isunbounded is used for checking the validity of the actual arguments. LRM 155

```

interface quiet_time_checker #(parameter min_quiet = 0,
                             parameter max_quiet = 0)
  (input logic clk, reset_n, [1:0]en);

```

LRM 156

```

generate
  if ( max_quiet == 0) begin
    property quiet_time;
      @(posedge clk) reset_n |-> ($countones(en) == 1);
    endproperty
    a1: assert property (quiet_time);
  end
  else begin
    property quiet_time;
      @(posedge clk)
        (reset_n && ($past(en) != 0) && en == 0)
        |->(en == 0) [*min_quiet:max_quiet]
        ##1 ($countones(en) == 1);
    endproperty
    a1: assert property (quiet_time);
  end
  if ((min_quiet == 0) && ($isunbounded(max_quiet))
    $display(warning_msg);
endgenerate
endinterface

```

```
quiet_time_checker #(0, 0) quiet_never (clk,1,enables);
quiet_time_checker #(2, 4) quiet_in_window (clk,1,enables);
quiet_time_checker #(0, $) quiet_any (clk,1,enables);
```

Another example below illustrates that by testing for \$, a property can be configured according to the requirements. When parameter `max_cks` is unbounded, it is not required to test for `expr` to become false.

```
interface width_checker #(parameter min_cks = 1, parameter max_cks = 1)
    (input logic clk, reset_n, expr);

    generate begin
        if ($isunbounded(max_cks)) begin
            property width;
                @(posedge clk)
                    (reset_n && $rose(expr)) |-> (expr [* min_cks]);
            endproperty
            a2: assert property (width);
        end
        else begin
            property assert_width_p;
                @(posedge clk)
                    (reset_n && $rose(expr)) |-> (expr[* min_cks:max_cks]
                    ##1 (!expr));
            endproperty
            a2: assert property (width);
        end
    endgenerate
endinterface
```

LRM 156

```
width_checker #(3, $) max_width_unspecified (clk,1,enables);
width_checker #(2, 4) width_specified (clk,1,enables);
```

SystemVerilog also adds the ability to omit the `parameter` keyword in a parameter port list.

```
class vector #(size = 1);
    logic [size-1:0] v;
endclass

typedef vector#(16) word;

interface simple_bus #(AWIDTH = 64, type T = word) (input bit clk) ;
endinterface
```

LRM 86

In a list of parameters, a parameter can depend on earlier parameters. In the following declaration, the default value of the second parameter depends on the value of the first parameter. The third parameter is a type, and the fourth parameter is a value of that type.

```
module mc # (int N = 5, M = N*16, type T = int, T x = 0)
    ( ... );
    ...
endmodule
```

LRM 102

Section 22 Configuration Libraries

22.1 Introduction (informative)

Verilog-2001 provides the ability to specify design configurations, which specify the binding information of module instances to specific Verilog HDL source code. Configurations utilize *libraries*. A library is a collection of modules, primitives and other configurations. Separate *library map files* specify the source code location for the cells contained within the libraries. The names of the library map files is typically specified as invocation options to simulators or other software tools reading in Verilog source code.

SystemVerilog adds support for interfaces to Verilog configurations.

LRM 58

22.2 Libraries

A library is a named collection of cells. A cell is a module, macromodule, primitive, interface, program, package, or configuration. A configuration is a specification of which source files bind to each instance in the design.

LRM 58

Section 23

System Tasks and System Functions

23.1 Introduction (informative)

SystemVerilog adds several system tasks and system functions as described in the following sections.

In addition, SystemVerilog extends the behavior of several Verilog-2001 system tasks, as described in Section 23.14.

23.2 Elaboration-time typeof function

LRM 111

```
typeof_function ::= // not in Annex A
    $typeof ( expression )
    | $typeof ( data_type )
```

Syntax 23-1—typeof function syntax (not in Annex A)

The `$typeof` system function returns a type derived from its argument. The data type returned by the `$typeof` system function may be used to assign or override a type parameter, or in a comparison with another `$typeof`, evaluated during elaboration.

When called with an expression as its argument, `$typeof` returns a type that represents the self-determined type result of the expression. The expression's return type is determined during elaboration but never evaluated. The expression shall not contain any hierarchical identifiers or references to elements of dynamic objects. In all contexts, `$typeof` together with its argument can be used in any place an elaboration constant is required.

When used in a comparison, equality (`==`) or case equality (`===`) is true if the operands are type equivalent (see Section 5.8, Type equivalency).

For example:

```
bit [12:0] A_bus, B_bus;
parameter type type bus_t = $typeof(A_bus);
generate
    case ($typeof(bus_t))
        $typeof(bit[12:0]): addfixed_int #(bus_t) (A_bus,B_bus);
        $typeof(real): add_float #($typeof(A_bus)) (A_bus,B_bus);
    endcase
endgenerate
```

LRM 242

The actual value returned by `$typeof` is not visible to the user and is not defined.

23.3 Typename function

LRM 111

```
typename_function ::= // not in Annex A
    $typename ( expression )
    | $typename ( data_type )
```

Syntax 23-2—typename function syntax (not in Annex A)

The `$typename` system function returns a string that represents the resolved type of its argument.

The return string is constructed in the following steps:

- 1) A typedef that creates an equivalent type is resolved back to built-in or user defined types.
- 2) The default signing is removed, even if present explicitly in the source
- 3) System generated names are created for anonymous structs, unions and enums.
- 4) A '\$' is used as the placeholder for the name of an anonymous unpacked array.
- 5) Actual encoded values are appended with numeration named constants. LRM 185
- 6) User defined type names are prefixed with their defining package or scope namespace.
- 7) Array ranges are represented as unsized decimal numbers.
- 8) Whitespace in the source is removed and a single space is added to separate identifiers and keywords from each other.

This process is similar to the way that type equality is computed, except that array ranges and built-in equivalent types are not normalized in the generated string. Thus `$typename` can be used in string comparisons for stricter type-checking of arrays than `$typeof`.

When called with an expression as its argument, `$typename` returns a string that represents the self-determined type result of the expression. The expression's return type is determined during elaboration but never evaluated. When used as an elaboration time constant, the expression shall not contain any hierarchical identifiers or references to elements of dynamic objects.

```

// source code                                     // $typename would return
typedef bit node;                                  // "bit"
node signed [2:0] X;                               // "bit signed[2:0]"
int signed Y;                                     // "int"
package A;
    enum {A,B,C=99} X;                             // "enum{A=32'd0,B=32'd1,C='32bX}A::e$1"
    typedef bit [9:1'b1] word                       // "A::bit[9:1]"
endpackage : A
import A.*;
module top;
    typedef struct {node A,B;} AB_t;
    AB_t AB[10];                                   // "struct{bit A;bit B;}top.AB_t$[0:9]"
    ...
endmodule
    
```

23.4 Expression size system function

<pre> size_function ::= \$bits (expression) \$bits (type_identifier) </pre>	<i>// not in Annex A</i>
---	--------------------------

LRM 111

Syntax 23-3—Size function syntax (not in Annex A)

The `$bits` system function returns the number of bits required to hold an expression as a bit stream. See Section 3.16, Bit-stream casting for a definition of legal types. A 4 state value counts as one bit. Given the declaration:

LRM 111

```
logic [31:0] foo;
```

Then `$bits(foo)` shall return 32, even if the implementation uses more than 32-bits of storage to represent the 4-state values. Given the declaration:

```
typedef struct {
    logic valid;
    bit [8:1] data;
} MyType;
```

The expression `$bits(MyType)` shall return 9, the number of data bits needed by a variable of type `MyType`.

The `$bits` function can be used as an elaboration-time constant when used on fixed sized types; hence, it can be used in the declaration of other types or variables.

```
typedef bit[$bits(MyType):1] MyBits; //same as typedef bit [9:1] MyBits;
MyBits b;
```

Variable `b` can be used to hold the bit pattern of a variable of type `MyType` without loss of information.

The `$bits` system function returns ~~logic-X~~ 0 when called with a dynamically sized type that is currently empty. It is an error to use the `$bits` system function directly with a dynamically sized type identifier.

LRM 279

23.5 Range system function

LRM 135

```
range_function ::= $isunbounded ( constant_expression ) // not in Annex A
```

Syntax 23-4—Range function syntax (not in Annex A)

The `$isunbounded` system function returns true if the argument is `$`. Given the declaration:

```
parameter int foo = $;
```

Then `$isunbounded` shall return true.

23.6 Shortreal conversions

Verilog 2001 defines a **real** data type, and the system functions `$realtobits` and `$bitstoreal` to permit exact bit pattern transfers between a **real** and a 64 bit vector. SystemVerilog adds the **shortreal** type, and in a parallel manner, `$shortrealtobits` and `$bitstoshortreal` are defined to permit exact bit transfers between a **shortreal** and a 32 bit vector.

```
[31:0] $shortrealtobits(shortreal_val) ;
shortreal $bitstoshortreal(bit_val) ;
```

`$shortrealtobits` converts from a **shortreal** number to the 32-bit representation (vector) of that short-real number. `$bitstoshortreal` is the reverse of `$shortrealtobits`; it converts from the bit pattern to a **shortreal** number.

23.7 Array querying system functions

```
array_query_functions ::=                                     // not in Annex A
    array_dimension_function ( array_identifier , dimension_expression )
    | array_dimension_function ( type_identifier [ , dimension_expression ] )
    | $dimensions ( array_identifier )
    | $dimensions ( type_identifier )
array_dimension_function ::=
    $left
    | $right
    | $low
    | $high
    | $increment
    | $size
dimension_expression ::= expression
```

LRM 111

Syntax 23-5—Array querying function syntax (not in Annex A)

SystemVerilog provides system functions to return information about a particular dimension of an array variable or type. The **return type is integer, and the** default for the optional dimension expression is 1. The array dimension can specify any fixed sized index (packed or unpacked), or any dynamically sized index (dynamic, associative, or queue).

LRM 111

LRM 244

- \$left shall return the left bound (msb) of the dimension
- \$right shall return the right bound (lsb) of the dimension
- \$low shall return the minimum of \$left and \$right of the dimension
- \$high shall return the maximum of \$left and \$right of the dimension
- \$increment shall return 1 if \$left is greater than or equal to \$right, and -1 if \$left is less than \$right
- \$size shall return the number of elements in the dimension, which is equivalent to \$high - \$low + 1
- \$dimensions shall return the number of dimensions in the array, or 0 for a singular object

The dimensions of an array shall be numbered as follows: The slowest varying dimension (packed or unpacked) is dimension 1. Successively faster varying dimensions have sequentially higher dimension numbers. Intermediate type definitions are expanded first before numbering the dimensions.

For example:

```
//      Dimension numbers
//      3      4      1      2
reg [3:0] [2:1] n [1:5] [2:8];
typedef reg [3:0] [2:1] packed_reg;
packed_reg n[1:5] [2:8]; // same dimensions as in the lines above
```

For a fixed sized integer type (**integer**, **shortint**, **longint**, and **byte**), dimension 1 is pre-defined. For an integer N declared without a range specifier, its bounds are assumed to be [\$bits(N) - 1:0].

If an out-of-range dimension is specified, these functions shall return a **logic~~X~~'x**.

LRM 244

When used on a dynamic array or queue dimension, these functions return information about the current state of the array. If the dimension is currently empty, these functions shall return a `logic X 'x`. It is an error to use these functions directly on a dynamically sized type identifier.

Use on associative array dimensions is restricted to index types with integral values. With integral indexes, these functions shall return:

- \$left shall return 0
- \$right shall return the highest possible index value
- \$low shall return the lowest currently allocated index value
- \$high shall return the largest currently allocated index value
- \$increment shall return -1
- \$size shall return the number of elements currently allocated

If the array identifier is a fixed sized array, these query functions can be used as a constant function and passed as a parameter before elaboration. These query functions can also be used on fixed sized type identifiers in which case it is always treated as a constant function.

Given the declaration below:

```
typedef logic [16:1] Word;
Word Ram[0:9];
```

The following system functions return 16:

```
$size(Word)
$size(Ram, 2)
```

23.8 Assertion severity system tasks

```
assert_severity_tasks ::= // not in Annex A
    fatal_message_task
    | nonfatal_message_task
fatal_message_task ::=
    $fatal ;
    | $fatal ( finish_number [ , message_argument { , message_argument } ] ) ;
nonfatal_message_task ::=
    severity_task ;
    | severity_task ( [ message_argument { , message_argument } ] ) ;
severity_task ::= $error | $warning | $info
finish_number ::= 0 | 1 | 2
message_argument ::= string | expression
```

Syntax 23-6—Assertion severity system task syntax (not in Annex A)

SystemVerilog assertions have a severity level associated with any assertion failures detected. By default, the severity of an assertion failure is “error”. The severity levels can be specified by including one of the following severity system tasks in the assertion fail statement:

- `$fatal` shall generate a run-time fatal assertion error, which terminates the simulation with an error code. The first argument passed to `$fatal` shall be consistent with the corresponding argument to the Verilog `$finish` system task, which sets the level of diagnostic information reported by the tool.
- `$error` shall be a run-time error.
- `$warning` shall be a run-time warning, which can be suppressed in a tool-specific manner.
- `$info` shall indicate that the assertion failure carries no specific severity.

All of these severity system tasks shall print a tool-specific message, indicating the severity of the failure, and specific information about the failure, which shall include the following information:

- The file name and line number of the assertion statement,
- The hierarchical name of the assertion, if it is labeled, or the scope of the assertion if it is not labeled.

For simulation tools, these tasks shall also report the simulation run-time at which the severity system task is called.

Each of the severity tasks can include optional user-defined information to be reported. The user-defined message shall use the same syntax as the Verilog `$display` system task, and can include any number of arguments.

23.9 Assertion control system tasks

```

assert_control_tasks ::=                                     // not in Annex A
    assert_task ;
    | assert_task ( levels [ , list_of_modules_or_assertions ] ) ;
assert_task ::=
    $asserton
    | $assertoff
    | $assertkill
list_of_modules_or_assertions ::=
    module_or_assertion { , module_or_assertion }
module_or_assertion ::=
    module_identifier
    | assertion_identifier
    | hierarchical_identifier
    
```

Syntax 23-7—Assertion control syntax (not in Annex A)

SystemVerilog provides three system tasks to control assertions.

- `$assertoff` shall stop the checking of all specified assertions until a subsequent `$asserton`. An assertion that is already executing, including execution of the pass or fail statement, is not affected
- `$assertkill` shall abort execution of any currently executing specified assertions and then stop the checking of all specified assertions until a subsequent `$asserton`.
- `$asserton` shall re-enable the execution of all specified assertions

23.10 Assertion system functions

```

assert_boolean_functions ::=                               // not in Annex A
    assert_function ( expression );
assert_function ::=
    $onehot
    | $onehot0
    | $isunknown

```

LRM 105

Syntax 23-8—Assertion system function syntax (not in Annex A)

Assertions are commonly used to evaluate certain specific characteristics of a design implementation, such as whether a particular signal is “one-hot”. The following system functions are included to facilitate such common assertion functionality:

- `$onehot` returns true if one and only one bit of expression is high.
- `$onehot0` returns true if at most one bit of expression is high.
- `$isunknown` returns true if any bit of the expression is `x` or `z`. This is equivalent to `^expression === 'bx`.

LRM 231

All of the above system functions shall have a return type of `bit`. A return value of `1'b1` shall indicate true, and a return value of `1'b0` shall indicate false.

A function is provided to return sampled value of an expression.

LRM 134

```
$sampled ( expression [, clocking_event] )
```

Three functions are provided for assertions to detect changes in values between two adjacent clock ticks.

```
$rose ( expression [, clocking_event] )
```

LRM 134

```
$fell ( expression [, clocking_event] )
```

```
$stable ( expression [, clocking_event] )
```

The past values can be accessed with the `$past` function.

```
$past ( expression [, number_of_ticks] [, expression2] [, clocking_event] )
```

`$sampled`, `$rose`, `$fell`, `$stable` and `$past` are discussed in Section 17.7.3.

The number of 1s in a bit vector expression can be determined with the `$countones` function.

```
$countones ( expression )
```

`$countones` is discussed in Section 17.10.

23.11 Random number system functions

To supplement the Verilog `$random` system function, SystemVerilog provides three special system functions for generating pseudorandom numbers, `$urandom`, `$urandom_range` and `$srandom`. These system functions are presented in Section 12.12.

23.12 Program control

In addition to the normal simulation control tasks (`$stop` and `$finish`), a program can use the `$exit` control task. When all programs exit, the simulation finishes. The usage of `$exit` is presented in Section 16.6 on program blocks.

23.13 Coverage system functions

SystemVerilog has several built-in system functions for obtaining test coverage information: `$coverage_control`, `$coverage_get_max`, `$coverage_get`, `$coverage_merge` and `$coverage_save`. The coverage system functions are described in Section 29.2.

23.14 Enhancements to Verilog-2001 system tasks

SystemVerilog adds system tasks and system functions as described in the following sections. In addition, SystemVerilog extends the behavior of the following:

- `%u` and `%z` format specifiers:
 - For packed data, `%u` and `%z` are defined to operate as though the operation were applied to the equivalent vector.
 - For unpacked struct data, `%u` and `%z` are defined to apply as though the operation were performed on each member in declaration order.
 - For unpacked union data, `%u` and `%z` are defined to apply as though the operation were performed on the first member in declaration order.
 - `%u` and `%z` are not defined on unpacked arrays.
 - The count of data items read by a `%u` or `%z` for an aggregate type is always either 1 or 0; the individual members are not counted separately.
- `$fread`
 - `$fread` has two variants—a register variant and a set of three memory variants.
 - The register variant,
 - ```
$fread(myreg, fd);
```
    - is defined to be the one applied for all packed data.
    - For unpacked struct data, `$fread` is defined to apply as though the operation were performed on each member in declaration order.
    - For unpacked union data, `$fread` is defined to apply as though the operation were performed on the first member in declaration order.
    - For unpacked arrays, the original definition applies except that unpacked struct or union elements are read as described above.

## 23.15 \$readmemb and \$readmemh

### 23.15.1 Reading packed data

LRM 79

`$readmemb` and `$readmemh` are extended to unpacked arrays of packed data, associative arrays of packed data, and dynamic arrays of packed data. In such cases, the system tasks treat each packed element as the vector equivalent and perform the normal operation.

When working with associative arrays, indexes must be of integral types.

### 23.15.2 Reading 2-state types

`$readmemb` and `$readmemh` are extended to packed data of 2-state type, such as `int` or enumerated types. For 2-state integer types, reading proceeds the same as for conventional Verilog reg types (e.g. integer), with the exception that X or Z data is converted to 0. For enumerated types, the file data represents the ordinal value of the enumerated type. (~~Cross-reference LRM section~~ See Section 3.10) If an enumeration ordinal is out of range for a given type, then an error shall be issued and no further reading shall take place.

LRM 261

## 23.16 \$writememb and \$writememh

LRM 79

SystemVerilog introduces system tasks `$writememb` and `$writememh`:

```
writemem_tasks ::= // not in Annex A
 $writememb (" file_name " , memory_name [, start_addr [, finish_addr]]);
 | $writememh (" file_name " , memory_name [, start_addr [, finish_addr]]);
```

### Syntax 23-9—*writemem* system task syntax (not in Annex A)

`$writememb` and `$writememh` are used to dump memory contents to files that are readable by `$readmemb` and `$readmemh`, respectively. If “file\_name” exists at the time `$writememb` or `$writememh` is called, the file will be overwritten (i.e. there is no append mode).

### 23.16.1 Writing packed data

`$writememb` and `$writememh` treat packed data identically to `$readmemb` and `$readmemh`. See Section 23.15.1

### 23.16.2 Writing 2-state types

`$writememb` and `$writememh` can write out data corresponding to unpacked arrays of 2-state types, such as `int` or enumerated types. For enumerated types, values in the file correspond to the ordinal values of the enumerated type. (See Section 3.10).

### 23.16.3 Writing addresses to output file

When `$writememb` and `$writememh` write out data corresponding to unpacked or dynamic arrays, address specifiers (@-words) shall not be written to the output file.

When `$writememb` and `$writememh` write out data corresponding to associative arrays, address specifiers shall be written to the output file.

## 23.17 File format considerations for multi-dimensional unpacked arrays

LRM 79

In SystemVerilog, `$readmemb`, `$readmemh`, `$writememb` and `$writememh` can work with multi-dimensional unpacked arrays.

The file contents are organized in row-major order, with each dimension’s entries ranging from low to high address. This is backward compatible with plain Verilog memories.

In this organization, the lowest dimension (i.e. the right-most dimension in the array declaration) varies the most rapidly. There is a hierarchical sense to the file data. The higher dimensions contain words of lower-dimension data, sorted in row-major order. Each successive lower dimension is entirely enclosed as part of higher dimension words.

As an example of file format organization, here is the layout of a file representing words for a memory declared:

```
reg [31:0] mem [0:2] [0:4] [5:8];
```

In the example word contents, wzyx,

- z corresponds to words of the [0:2] dimension
- y corresponds to words of the [0:4] dimension
- x corresponds to words of the [5:8] dimension

```
w005 w006 w007 w008
w015 w016 w017 w018
w025 w026 w027 w028
w035 w036 w037 w038
w045 w046 w047 w048
w105 w106 w107 w108
w115 w116 w117 w118
w125 w126 w127 w128
w135 w136 w137 w138
w145 w146 w147 w148
w205 w206 w207 w208
w215 w216 w217 w218
w225 w226 w227 w228
w235 w236 w237 w238
w245 w246 w247 w248
```

Note that the diagram would be identical if one or more of the unpacked dimension declarations were reversed, as in:

```
reg [31:0] mem [2:0] [0:4] [8:5]
```

Address entries in the file exclusively address the highest dimension's words. In the above case, address entries in the file could look something as follows:

```
@0 w005 w006 w007 w008
 w015 w016 w017 w018
 w025 w026 w027 w028
 w035 w036 w037 w038
 w045 w046 w047 w048
@1 w105 w106 w107 w108
 w115 w116 w117 w118
 w125 w126 w127 w128
 w135 w136 w137 w138
 w145 w146 w147 w148
@2 w205 w206 w207 w208
 w215 w216 w217 w218
 w225 w226 w227 w228
 w235 w236 w237 w238
 w245 w246 w247 w248
```

When \$readmemh or \$readmemb is given a file without address entries, all data is read assuming that each dimension has complete data. i.e. each word in each dimension will be initialized with the appropriate value from the file. If the file contains incomplete data, the read operation will stop at the last initialized word, and any remaining array words or sub words will be left unchanged.

When \$readmemh or \$readmemb is given a file with address entries, initialization of the specified highest dimension words is done. If the file contains insufficient words to completely fill a highest dimension word,

then the remaining sub words are left unchanged.

When a memory contains multiple packed dimensions, the memory words in the pattern file are composed of the sum total of all bits in the packed dimensions. The layout of packed bits in packed dimensions is defined in Section 4.3.

LRM 175

### 23.18 System task arguments for multi-dimensional unpacked arrays

LRM 79

The `$readmemb`, `$readmemh`, `$writememb`, and `$writememh` signatures are shown below:

```
$readmemb("file_name", memory_name[, start_addr[, finish_addr]]);
$readmemh("file_name", memory_name[, start_addr[, finish_addr]]);
$writememb("file_name", memory_name[, start_addr[, finish_addr]]);
$writememh("file_name", memory_name[, start_addr[, finish_addr]]);
```

*memory\_name* can be an unpacked array, or a partially indexed multi-dimensional unpacked array that resolves to a lesser-dimensional unpacked array.

Higher order dimensions must be specified with an index, rather than a complete or partial dimension range. The lowest dimension (i.e. the right-most specified dimension in the identifier) can be specified with slice syntax. See Section 4.4 for details on legal array indexing in SystemVerilog.

The *start\_addr* and *finish\_addr* arguments apply to the addresses of the unpacked array selected by *memory\_name*. This address range represents the highest dimension of data in the *file\_name*.

When slice syntax is used in the *memory\_name* argument, any *start\_addr* and *finish\_addr* arguments must fall within the bounds of the slice's range.

The direction of the highest dimension's file entries is given by the relative magnitudes of *start\_addr* and *finish\_addr*, as is the case in 1364-2001.

## Section 24 VCD Data

SystemVerilog does not extend the VCD format. Some SystemVerilog types can be dumped into a standard VCD file by masquerading as a Verilog type. The following table lists the basic SystemVerilog types and their mapping to a Verilog type for VCD dumping.

**Table 24-1: VCD type mapping**

| SystemVerilog | Verilog | Size                     |
|---------------|---------|--------------------------|
| bit           | reg     | Size of packed dimension |
| logic         | reg     | Size of packed dimension |
| int           | integer | 32                       |
| shortint      | integer | 16                       |
| longint       | integer | 64                       |
| shortreal     | real    |                          |
| byte          | reg     | 8                        |
| enum          | integer | 32                       |

Packed arrays and structures are dumped as a single vector of **reg**. Multiple packed array dimensions are collapsed into a single dimension.

If an **enum** declaration specified a type, it is dumped as that type rather than the default shown above.

Unpacked structures appear as named **fork...join** blocks, and their member elements of the structure appear as the types above. Since named **fork...join** blocks with variable declarations are seldom used in testbenches and hardware models, this makes structures easy to distinguish from variables declared in **begin...end** blocks, which are more frequently used in testbenches and models.

As in Verilog 2001, unpacked arrays and automatic variables are not dumped.

Note that the current VCD format does not indicate whether a variable has been declared as **signed** or **unsigned**.

## Section 25 Compiler Directives

### 25.1 Introduction (informative)

Verilog provides the ``define` text substitution macro compiler directive. A macro can contain arguments, whose values can be set for each instance of the macro. For example:

```
`define NAND(dval) nand nand #(dval)

`NAND(3) i1 (y, a, b); //`NAND(3) macro substitutes with: nand #(3)

`NAND(3:4:5) i2 (o, c, d); //`NAND(3:4:5) macro substitutes with: nand
#(3:4:5)
```

LRM 242

SystemVerilog enhances the capabilities of the ``define` compiler directive to support the construction of string literals and identifiers.

Verilog provides the ``include` file inclusion compiler directive. SystemVerilog enhances the capabilities to support standard include specification, and enhances the ``include` directive to accept a file name constructed with a macro.

### 25.2 ``define` macros

In Verilog, the ``define` macro text can include a backslash (`\`) at the end of a line to show continuation on the next line.

In SystemVerilog, the macro text can also include ``"`, ``\`"` and ``\``.

An ``"` overrides the usual lexical meaning of `"`, and indicates that the expansion should include an actual quotation mark. This allows string literals to be constructed from macro arguments.

A ``\`"` indicates that the expansion should include the escape sequence `\`, e.g.

```
`define msg(x,y) `x: `\`"y`\`"``
```

This expands:

```
$display(`msg(left side,right side));
```

to:

```
$display("left side: \"right side\");
```

A ``\`` delimits lexical tokens without introducing white space, allowing identifiers to be constructed from arguments, e.g.

```
`define foo(f) f`\`_suffix
```

This expands:

```
`foo(bar)
```

to:

```
bar_suffix
```

The ``include` directive can be followed by a macro, instead of a literal string:

```
`define home(filename) `"/home/fo0/myfilefilename`"
`include `home(myfile)
```

LRM 218

### 25.3 ``include`

The syntax of the ``include` compiler directive is:

```
include_compiler_directive ::=
 `include "filename"
 | `include <filename>
```

When the filename is an absolute path, only that filename is included and only the double quote form of the ``include` can be used.

When the double quote ("filename") version is used, the behavior of ``include` is unchanged from IEEE Std. 1364-2001.

When the angle bracket (<filename>) notation is used, then only the vendor defined location containing files defined by the language standard is searched. Relative path names given inside the < > are interpreted relative to the vendor-defined location in all cases.

## Section 26

# Features under consideration for removal from SystemVerilog

### 26.1 Introduction (informative)

Certain Verilog language features can be simulation inefficient, easily abused, and the source of design problems. These features are being considered for removal from the SystemVerilog language, if there is an alternate method for these features.

The Verilog language features that have been identified in this standard as ones which can be removed from Verilog are **defparam** and procedural **assign/deassign**.

### 26.2 Defparam statements

The SystemVerilog committee has determined, based on the solicitation of input from tool implementers and tools users, that the **defparam** method of specifying the value of a parameter can be a source of design errors, and can be an impediment to tool implementation. The **defparam** statement does not provide a capability that cannot be done by another method, which avoids these problems. Therefore, the committee has placed the **defparam** statement on a deprecation list. This means is that a future revision of the Verilog standard might not require support for this feature. This current standard still requires tools to support the **defparam** statement. However, users are strongly encouraged to migrate their code to use one of the alternate methods of parameter redefinition.

Prior to the acceptance of the Verilog-2001 Standard, it was common practice to change one or more parameters of instantiated modules using a separate **defparam** statement. **Defparam** statements can be a source of tool complexity and design problems.

A **defparam** statement can precede the instance to be modified, can follow the instance to be modified, can be at the end of the file that contains the instance to be modified, can be in a separate file from the instance to be modified, can modify parameters hierarchically that in turn must again be passed to other **defparam** statements to modify, and can modify the same parameter from two different **defparam** statements (with undefined results). Due to the many ways that a **defparam** can modify parameters, a Verilog compiler cannot insure the final parameter values for an instance until after all of the design files are compiled.

Prior to Verilog-2001, the only other method available to change the values of parameters on instantiated modules was to use implicit in-line parameter redefinition. This method uses  `#(parameter_value)` as part of the module instantiation. Implicit in-line parameter redefinition syntax requires that all parameters up to and including the parameter to be changed must be placed in the correct order, and must be assigned values.

Verilog-2001 introduced explicit in-line parameter redefinition, in the form  `#( .parameter_name(value) )`, as part of the module instantiation. This method gives the capability to pass parameters by name in the instantiation, which supplies all of the necessary parameter information to the model in the instantiation itself.

The practice of using **defparam** statements is highly discouraged. Engineers are encouraged to take advantage of the Verilog-2001 explicit in-line parameter redefinition capability.

See Section 21 for more details on parameters.

### 26.3 Procedural assign and deassign statements

The SystemVerilog committee has determined, based on the solicitation of input from tool implementers and tools users, that the procedural **assign** and **deassign** statements can be a source of design errors, and can be an impediment to tool implementation. The procedural **assign/deassign** statements do not provide a capability that cannot be done by another method, which avoids these problems. Therefore, the committee has placed the procedural **assign/deassign** statements on a deprecation list. This means that a future revision of the Verilog standard might not require support for these statements. This current standard still requires tools to



support the procedural **assign/deassign** statements. However, users are strongly encouraged to migrate their code to use one of the alternate methods of procedural or continuous assignments.

Verilog has two forms of the **assign** statement:

- Continuous assignments, placed outside of any procedures
- Procedural continuous assignments, placed within a procedure

Continuous assignment statements are a separate process that are active throughout simulation. The continuous assignment statement accurately represents combinational logic at an RTL level of modeling, and is frequently used.

Procedural continuous assignment statements become active when the **assign** statement is executed in the procedure. The process can be de-activated using a **deassign** statement. The procedural **assign/deassign** statements are seldom needed to model hardware behavior. In the unusual circumstances where the behavior of procedural continuous assignments are required, the same behavior can be modeled using the procedural force and release statements.

The fact that the **assign** statement to be used both outside and inside a procedure can cause confusion and errors in Verilog models. The practice of using the **assign** and **deassign** statements inside of procedural blocks is highly discouraged.

~~See Section 8 for more information on procedural assignments.~~

LRM 261

## Section 27

# Direct Programming Interface (DPI)

This chapter highlights the Direct Programming Interface and provides a detailed description of the SystemVerilog layer of the interface. The C layer is defined in Annex E.

### 27.1 Overview

Direct Programming Interface (DPI) is an interface between SystemVerilog and a foreign programming language. It consists of two separate layers: the SystemVerilog layer and a foreign language layer. Both sides of DPI are fully isolated. Which programming language is actually used as the foreign language is transparent and irrelevant for the SystemVerilog side of this interface. Neither the SystemVerilog compiler nor the foreign language compiler is required to analyze the source code in the other's language. Different programming languages can be used and supported with the same intact SystemVerilog layer. For now, however, SystemVerilog 3.1 defines a foreign language layer only for the C programming language. See Annex E for more details.

The motivation for this interface is two-fold. The methodological requirement is that the interface should allow a heterogeneous system to be built (a design or a testbench) in which some components can be written in a language (or more languages) other than SystemVerilog, hereinafter called the foreign language. On the other hand, there is also a practical need for an easy and efficient way to connect existing code, usually written in C or C++, without the knowledge and the overhead of PLI or VPI.

DPI follows the principle of a black box: the specification and the implementation of a component is clearly separated and the actual implementation is transparent to the rest of the system. Therefore, the actual programming language of the implementation is also transparent, though this standard defines only C linkage semantics. The separation between SystemVerilog code and the foreign language is based on using functions as the natural encapsulation unit in SystemVerilog. By and large, any function can be treated as a black box and implemented either in SystemVerilog or in the foreign language in a transparent way, without changing its calls.

#### 27.1.1 Tasks and functions

LRM 132

DPI allows direct inter-language function calls between the languages on either side of the interface. Specifically, functions implemented in a foreign language can be called from SystemVerilog; such functions are referred to as *imported functions*. SystemVerilog functions that are to be called from a foreign code shall be specified in export declarations (see Section 27.6 for more details). DPI allows for passing SystemVerilog data between the two domains through function arguments and results. There is no intrinsic overhead in this interface.

It is also possible to perform task enables across the language boundary. Foreign code can call SystemVerilog tasks, and native Verilog code can call imported tasks. An imported task has the same semantics as a native Verilog task: It never returns a value, and it can block and consume simulation time.

LRM 132

All functions used in DPI are assumed to complete their execution instantly and consume 0 (zero) simulation time, just as normal SystemVerilog functions. DPI provides no means of synchronization other than by data exchange and explicit transfer of control.

Every imported task and function needs to be declared. A declaration of an imported task or function is referred to as an *import declaration*. Import declarations are very similar to SystemVerilog task and function declarations. Import declarations can occur anywhere where SystemVerilog task and function definitions are permitted. An import declaration is considered to be a definition of a SystemVerilog task or function with a foreign language implementation. The same foreign task or function can be used to implement multiple SystemVerilog tasks and functions (this can be a useful way of providing differing default argument values for the same basic task or function), but a given SystemVerilog name can only be defined once per scope. Imported task and functions can have zero or more formal **input**, **output**, and **inout** arguments. Imported tasks always return a void value, and thus can only be used in statement context. Imported functions can return a result or be defined as void functions.

LRM 132

DPI is based entirely upon SystemVerilog constructs. The usage of imported functions is identical as for native SystemVerilog functions. With few exceptions imported functions and native functions are mutually interchangeable. Calls of imported functions are indistinguishable from calls of SystemVerilog functions. This facilitates ease-of-use and minimizes the learning curve. Similar interchangeable semantics exist between native SystemVerilog tasks and imported tasks.

LRM 132

### 27.1.2 Data types

SystemVerilog data types are the sole data types that can cross the boundary between SystemVerilog and a foreign language in either direction (i.e., when an imported function is called from SystemVerilog code or an exported SystemVerilog function is called from a foreign code). It is not possible to import the data types or directly use the type syntax from another language. A rich subset of SystemVerilog data types is allowed for formal arguments of import and export functions, although with some restrictions and with some notational extensions. Function result types are restricted to small values, however (see Section 27.4.5).

Formal arguments of an imported function can be specified as open arrays. A formal argument is an open array when a range of one or more of its dimensions, packed or unpacked, is unspecified. An open array is like a multi-dimensional dynamic array formal in both packed and unpacked dimensions, and is thus denoted using the same syntax as dynamic arrays, using [] to denote an open dimension. This is solely a relaxation of the argument-matching rules. An actual argument shall match the formal one regardless of the range(s) for its corresponding dimension(s), which facilitates writing generalized code that can handle SystemVerilog arrays of different sizes. See Section 27.4.6.1.

#### 27.1.2.1 Data representation

DPI does not add any constraints on how SystemVerilog-specific data types are actually implemented. Optimal representation can be platform dependent. The layout of 2- or 4-state packed structures and arrays is implementation- and platform-dependent.

The implementation (representation and layout) of 4-state values, structures, and arrays is irrelevant for SystemVerilog semantics, and can only impact the foreign side of the interface.

## 27.2 Two layers of the DPI

DPI consists of two separate layers: the SystemVerilog layer and a foreign language layer. The SystemVerilog layer does not depend on which programming language is actually used as the foreign language. Although different programming languages can be supported and used with the intact SystemVerilog layer, SystemVerilog 3.1 defines a foreign language layer only for the C programming language. Nevertheless, SystemVerilog code shall look identical and its semantics shall be unchanged for any foreign language layer. Different foreign languages can require that the SystemVerilog implementation shall use the appropriate function call protocol, argument passing and linking mechanisms. This shall be, however, transparent to SystemVerilog users. SystemVerilog 3.1 requires only that its implementation shall support C protocols and linkage.

### 27.2.1 DPI SystemVerilog layer

The SystemVerilog side of DPI does not depend on the foreign programming language. In particular, the actual function call protocol and argument passing mechanisms used in the foreign language are transparent and irrelevant to SystemVerilog. SystemVerilog code shall look identical regardless of what code the foreign side of the interface is using. The semantics of the SystemVerilog side of the interface is independent from the foreign side of the interface.

This chapter does not constitute a complete interface specification. It only describes the functionality, semantics and syntax of the SystemVerilog layer of the interface. The other half of the interface, the foreign language layer, defines the actual argument passing mechanism and the methods to access (read/write) formal arguments from the foreign code. See Annex E for more details.

## 27.2.2 DPI foreign language layer

The foreign language layer of the interface (which is transparent to SystemVerilog) shall specify how actual arguments are passed, how they can be accessed from the foreign code, how SystemVerilog-specific data types (such as **logic** and **packed**) are represented, and how to translate them to and from some predefined C-like types.

The data types allowed for formal arguments and results of imported functions or exported functions are generally SystemVerilog types (with some restrictions and with notational extensions for open arrays). The user is responsible for specifying in their foreign code the native types equivalent to the SystemVerilog types used in imported declarations or export declarations. Software tools, like a SystemVerilog compiler, can facilitate the mapping of SystemVerilog types onto foreign native types by generating the appropriate function headers.

The SystemVerilog compiler or simulator shall generate and/or use the function call protocol and argument passing mechanisms required for the intended foreign language layer. The same SystemVerilog code (compiled accordingly) shall be usable with different foreign language layers, regardless of the data access method assumed in a specific layer. Annex F defines DPI foreign language layer for the C programming language.

LRM 132

## 27.3 Global name space of imported and exported functions

Every task or function imported to SystemVerilog must eventually resolve to a global symbol. Similarly, every task or function exported from SystemVerilog defines a global symbol. Thus the tasks and functions imported to and exported from SystemVerilog have their own global name space of linkage names, different from compilation-unit scope name space. Global names of imported and exported tasks and functions must be unique (no overloading is allowed) and shall follow C conventions for naming; specifically, such names must start with a letter or underscore, and can be followed by alphanumeric characters or underscores. Exported and imported tasks and functions, however, can be declared with local SystemVerilog names. Import and export declarations allow users to specify a global name for a function in addition to its declared name. Should a global name clash with a SystemVerilog keyword or a reserved name, it shall take the form of an escaped identifier. The leading backslash ( \ ) character and the trailing white space shall be stripped off by the SystemVerilog tool to create the linkage identifier. Note that after this stripping, the linkage identifier so formed must comply with the normal rules for C identifier construction. If a global name is not explicitly given, it shall be the same as the SystemVerilog task or function name. For example:

LRM 132

LRM 58

```
export "DPI" foo_plus = function \foo+ ; // "foo+" exported as "foo_plus"
export "DPI" function foo; // "foo" exported under its own name
import "DPI" init_1 = function void \init[1] (); // "init_1" is a linkage name
import "DPI" \begin = function void \init[2] (); // "begin" is a linkage name
```

The same global task or function can be referred to in multiple import declarations in different scopes or/and with different SystemVerilog names, see Section 27.4.4.

LRM 132

Multiple export declarations are allowed with the same *c\_identifier*, explicit or implicit, as long as they are in different scopes and have the same type signature (as defined in Section 27.4.4 for imported tasks and functions). Multiple export declarations with the same *c\_identifier* in the same scope are forbidden.

## 27.4 Imported tasks and functions

LRM 132

The usage of imported functions is similar as for native SystemVerilog functions.

### 27.4.1 Required properties of imported tasks and functions — semantic constraints

LRM 141

This section defines the semantic constraints imposed on imported tasks or functions. Some semantic restrictions are shared by all imported tasks or functions. Other restrictions depend on whether the special properties **pure** (see Section 27.4.2) or **context** (see Section 27.4.3) are specified for an imported task or function. A SystemVerilog compiler is not able to verify that those restrictions are observed and if those restrictions are not satisfied, the effects of such imported task or function calls can be unpredictable.

### 27.4.1.1 Instant completion of imported functions

LRM 132

Imported functions shall complete their execution instantly and consume zero-simulation time, similarly to native functions.

Note that imported tasks can consume time, similar to native SystemVerilog tasks.

### 27.4.1.2 input, output and inout arguments

Imported functions can have `input`, `output` and `inout` arguments. The formal `input` arguments shall not be modified. If such arguments are changed within a function, the changes shall not be visible outside the function; the actual arguments shall not be changed.

The imported function shall not assume anything about the initial values of formal `output` arguments. The initial values of `output` arguments are undetermined and implementation-dependent.

The imported function can access the initial value of a formal `inout` argument. Changes that the imported function makes to a formal `inout` argument shall be visible outside the function.

LRM 38

### 27.4.1.3 Special properties pure and context

Special properties can be specified for an imported task or function: as `pure` or as `context` (see also Section 27.4.2 or 27.4.3 ).

LRM 132

A function whose result depends solely on the values of its input arguments and with no side effects can be specified as `pure`. This can usually allow for more optimizations and thus can result in improved simulation performance. Section 27.4.2 details the rules that must be obeyed by pure functions. An imported task can never be declared pure.

An imported task or function that is intended to call exported tasks or functions or to access SystemVerilog data objects other than its actual arguments (e.g. via VPI or PLI calls) must be specified as `context`. Calls of context tasks and functions are specially instrumented and can impair SystemVerilog compiler optimizations; therefore simulation performance can decrease if the `context` property is specified when not necessary. A task or function not specified as `context` shall not read or write any data objects from SystemVerilog other than its actual arguments. For tasks or functions not specified as `context`, the effects of calling PLI, VPI, or exported SystemVerilog tasks or functions can be unpredictable and can lead to unexpected behavior; such calls can even crash. Section 27.4.3 details the restrictions that must be obeyed by non-context tasks or functions.

If neither the pure nor the context attribute is used on an imported task or function, the task or function shall not access SystemVerilog data objects, however it can perform side-effects such as writing to a file or manipulating a global variable.

LRM 142

### 27.4.1.4 Memory management

The memory spaces owned and allocated by the foreign code and SystemVerilog code are disjointed. Each side is responsible for its own allocated memory. Specifically, an imported function shall not free the memory allocated by SystemVerilog code (or the SystemVerilog compiler) nor expect SystemVerilog code to free the memory allocated by the foreign code (or the foreign compiler). This does not exclude scenarios where foreign code allocates a block of memory, then passes a handle (i.e., a pointer) to that block to SystemVerilog code, which in turn calls an imported function (e.g. C standard function `free`) which directly or indirectly frees that block.

NOTE—In this last scenario, a block of memory is allocated and freed in the foreign code, even when the standard functions `malloc` and `free` are called directly from SystemVerilog code.

### 27.4.1.5 Reentrancy of imported tasks

LRM 132

Since imported tasks can block (consume time), it is possible for an imported task's C code to be simultaneously active in multiple execution threads. Standard reentrancy considerations must be made by the C programmer. Some examples of

such considerations include safe use of static variables, and ensuring that only thread-safe C standard library calls (MT safe) are used.

#### 27.4.1.6 C++ exceptions

LRM 132

It is possible to implement DPI imported tasks and functions using C++, as long as C linkage conventions are observed at the language boundary. If C++ is used, exceptions must not propagate out of any imported task or function. Undefined behavior will result if an exception crosses the language boundary from C++ into SystemVerilog.

#### 27.4.2 Pure functions

A **pure** function call can be safely eliminated if its result is not needed or if the previous result for the same values of input arguments is available somehow and can be reused without needing to recalculate. Only non-void functions with no **output** or **inout** arguments can be specified as **pure**. Functions specified as **pure** shall have no side effects whatsoever; their results need to depend solely on the values of their input arguments. Calls to such functions can be removed by SystemVerilog compiler optimizations or replaced with the values previously computed for the same values of the input arguments.

Specifically, a pure function is assumed not to directly or indirectly (i.e., by calling other functions):

- perform any file operations
- read or write anything in the broadest possible meaning, includes i/o, environment variables, objects from the operating system or from the program or other processes, shared memory, sockets, etc.
- access any persistent data, like global or static variables.

If a pure function does not obey the above restrictions, SystemVerilog compiler optimizations can lead to unexpected behavior, due to eliminated calls or incorrect results being used.

#### 27.4.3 Context tasks and functions

LRM 141

Some DPI imported tasks or functions require that the context of their call is known. It takes special instrumentation of their call instances to provide such context; for example, an internal variable referring to the “current instance” might need to be set. To avoid any unnecessary overhead, imported task or function calls in SystemVerilog code are not instrumented unless the imported task or function is specified as **context**.

LRM 132

All DPI exported tasks or functions require that the context of their call is known. This occurs since SystemVerilog task or function declarations always occur in instantiable scopes, hence allowing a multiplicity of unique task or function instances.

For the sake of simulation performance, an imported task or function call shall not block SystemVerilog compiler optimizations. An imported task or function not specified as **context** shall not access any data objects from SystemVerilog other than its actual arguments. Only the actual arguments can be affected (read or written) by its call. Therefore, a call of a non-context task or function is not a barrier for optimizations. A context imported task or function, however, can access (read or write) any SystemVerilog data objects by calling PLI/VPI, or by calling an export task or function. Therefore, a call to a context task or function is a barrier for SystemVerilog compiler optimizations.

Only calls of context imported tasks or functions are properly instrumented and cause conservative optimizations; therefore, only those tasks or functions can safely call all tasks or functions from other APIs, including PLI and VPI functions or exported SystemVerilog tasks or functions. For imported tasks or functions not specified as **context**, the effects of calling PLI or VPI functions or SystemVerilog tasks or functions can be unpredictable and such calls can crash if the callee requires a context that has not been properly set. However note that declaring an import context task or function does not automatically make any other simulator interface automatically available. For VPI access (or any other interface access) to be possible, the appropriate implementation defined mechanism must still be used to enable these interface(s). Note also that DPI calls do not automatically create or provide any handles or any special environment that can be needed by those other interfaces. It is the user’s responsibility to create, manage or otherwise manipulate the required handles/envi-

LRM 142

ronment(s) needed by the other interfaces.

Context imported tasks or functions are always implicitly supplied a scope representing the fully qualified instance name within which the import declaration was present. This scope defines which exported SystemVerilog tasks or functions can be called directly from the imported task or function; only tasks or functions defined and exported from the same scope as the import can be called directly. To call any other exported SystemVerilog tasks or functions, the imported task or function shall first have to modify its current scope, in essence performing the foreign language equivalent of a SystemVerilog hierarchical task or function call.

Special DPI utility functions exist that allow imported task or functions to retrieve and operate on their scope. See Annex E for more details.

LRM 141

## 27.4.4 Import declarations

Each imported task or function shall be declared. Such declaration are referred to as *import declarations*. The syntax of an **import** declaration is similar to the syntax of SystemVerilog task or function prototypes (see Section 10.5).

Imported tasks or functions are similar to SystemVerilog tasks or functions. Imported tasks or functions can have zero or more formal **input**, **output**, and **inout** arguments. Imported functions can return a result or be defined as void functions. Imported tasks never return a result, and thus are always declared in foreign code as void functions.

```

dpi_import_export ::= // from Annex A.2.6
 import "DPI" [dpi_function_import_property] [c_identifier =] dpi_function_proto ;
 | import "DPI" [dpi_task_import_property] [c_identifier =] dpi_task_proto ;
 | export "DPI" [c_identifier =] function function_identifier ;
 | export "DPI" [c_identifier =] task task task_identifier ;

dpi_function_import_property ::= context | pure
dpi_task_import_property ::= context

dpi_function_proto9,10 ::= function named_function_proto
dpi_task_proto10 ::= task named_task_proto
named_function_proto ::= [signing] function_data_type function_identifier ([list_of_tf_proto_formals
 tf_port_list])
named_task_proto ::= task_identifier ([list_of_tf_proto_formals tf_port_list]) | // from Annex A.2.7
list_of_tf_proto_formals ::=
 { attribute_instance } tf_proto_formal { , { attribute_instance } tf_proto_formal }
tf_proto_formal ::=
 tf_input_declaration
 † tf_output_declaration
 † tf_inout_declaration
 † tf_ref_declaration

NOTES: // from Annex A.10
9) dpi_function_proto return types are restricted to small values, as per 27.4.5.
10) Formals of dpi_function_proto and dpi_task_proto cannot use pass by reference mode and class types
cannot be passed at all; for the complete set of restrictions see 27.4.6.

```

LRM 247  
LRM 261

LRM 132

LRM 5

LRM 17

LRM 145

### Syntax 27-1—DPI import declaration syntax (excerpt from Annex A)

An import declaration specifies the task or function name, function result type, and types and directions of for-

mal arguments. It can also provide optional default values for formal arguments. Formal argument names are optional unless argument passing by name is needed. An import declaration can also specify an optional task or function property. Imported functions can have the properties **context** or **pure**; imported tasks can have the property **context**.

LRM 132

Note that an import declaration is equivalent to defining a task or function of that name in the SystemVerilog scope in which the import declaration occurs, and thus multiple imports of the same task or function name into the same scope are forbidden. Note that this declaration scope is particularly important in the case of imported context tasks or functions, see Section 27.4.3; for non-context imported tasks or functions the declaration scope has no other implications other than defining the visibility of the task or function.

*c\_identifier* provides the linkage name for this task or function in the foreign language. If not provided, this defaults to the same identifier as the SystemVerilog task or function name. In either case, this linkage name must conform to C identifier syntax. An error shall occur if the *c\_identifier*, either directly or indirectly, does not conform to these rules.

For any given *c\_identifier* (whether explicitly defined with *c\_identifier*=, or automatically determined from the task or function name), all declarations, regardless of scope, must have exactly the same type signature. The signature includes the return type and the number, order, direction and types of each and every argument. Type includes dimensions and bounds of any arrays or array dimensions. Signature also includes the **pure/context** qualifiers that can be associated with an extern definition.

Note that multiple declarations of the same imported or exported task or function in different scopes can vary argument names and default values, provided the type compatibility constraints are met.

A formal argument name is required to separate the packed and the unpacked dimensions of an array.

The qualifier **ref** cannot be used in import declarations. The actual implementation of argument passing depends solely on the foreign language layer and its implementation and shall be transparent to the SystemVerilog side of the interface.

The following are examples of external declarations.

```
import "DPI" function void myInit();

// from standard math library
import "DPI" pure function real sin(real);

// from standard C library: memory management
import "DPI" functionchandle malloc(int size); // standard C function
import "DPI" function void free(chandle ptr); // standard C function

// abstract data structure: queue
import "DPI" functionchandle newQueue(input string name_of_queue);

// Note the following import uses the same foreign function for
// implementation as the prior import, but has different SystemVerilog name
// and provides a default value for the argument.
import "DPI" newQueue=functionchandle newAnonQueue(input string s=null);
import "DPI" functionchandle newElem(bit [15:0]);
import "DPI" function void enqueue(chandle queue, chandle elem);
import "DPI" functionchandle dequeue(chandle queue);

// miscellanea
import "DPI" function bit [15:0] getStimulus();
import "DPI" context function void processTransaction(chandle elem,
 output logic [64:1] arr [0:63]);
import "DPI" task checkResults(input string s, bit [511:0] packet);
```

LRM 132



### 27.4.5 Function result

Function result types are restricted to small values. The following SystemVerilog data types are allowed for imported function results:

- `void`, `byte`, `shortint`, `int`, `longint`, `real`, `shortreal`, `chandle`, and `string`
- packed bit arrays up to 32 bits and all types that are eventually equivalent to packed bit arrays up to 32 bits
- scalar values of type `bit` and `logic`

LRM 217

The same restrictions apply for the result types of exported functions.

### 27.4.6 Types of formal arguments

A rich subset of SystemVerilog data types is allowed for formal arguments of import and export tasks or functions. Generally, C compatible types, packed types and user defined types built of types from these two categories can be used for formal arguments of DPI tasks or functions. The set of permitted types is defined inductively.

LRM 132

The following SystemVerilog types are the only permitted types for formal arguments of import and export tasks or functions:

- `void`, `byte`, `shortint`, `int`, `longint`, `real`, `shortreal`, `chandle`, and `string`
- scalar values of type `bit` and `logic`
- packed one dimensional arrays of type `bit` and `logic`

Note however, that every packed type, whatever is its structure, is eventually equivalent to a packed one dimensional array. Therefore practically all packed types are supported, although their internal structure (individual fields of structs, multiple dimensions of arrays) shall be transparent and irrelevant.

- enumeration types interpreted as the type associated with that enumeration
- types constructed from the supported types with the help of the constructs:
  - `struct`
  - unpacked array
  - `typedef`

The following caveats apply for the types permitted in DPI:

- Enumerated data types are not supported directly. Instead, an enumerated data type is interpreted as the type associated with that enumerated type.
- SystemVerilog does not specify the actual memory representation of packed structures or any arrays, packed or unpacked. Unpacked structures have an implementation-dependent packing, normally matching the C compiler.
- The actual memory representation of SystemVerilog data types is transparent for SystemVerilog semantics and irrelevant for SystemVerilog code. It can be relevant for the foreign language code on the other side of the interface, however; a particular representation of the SystemVerilog data types can be assumed. This shall not restrict the types of formal arguments of imported tasks or functions, with the exception of unpacked arrays. SystemVerilog implementation can restrict which SystemVerilog unpacked arrays are passed as actual arguments for a formal argument which is a sized array, although they can be always passed for an unsized (i.e., open) array. Therefore, the correctness of an actual argument might be implementation-dependent. Nevertheless, an open array provides an implementation-independent solution.

LRM 132

### 27.4.6.1 Open arrays

The size of the packed dimension, the unpacked dimension, or both dimensions can remain unspecified; such cases are referred to as *open arrays* (or *unsized arrays*). Open arrays allow the use of generic code to handle different sizes.

Formal arguments of imported functions can be specified as open arrays. (Exported SystemVerilog functions cannot have formal arguments specified as open arrays.) A formal argument is an open array when a range of one or more of its dimensions is unspecified (denoted by using square brackets ([ ])). This is solely a relaxation of the argument-matching rules. An actual argument shall match the formal one regardless of the range(s) for its corresponding dimension(s), which facilitates writing generalized code that can handle SystemVerilog arrays of different sizes.

Although the packed part of an array can have an arbitrary number of dimensions, in the case of open arrays only a single dimension is allowed for the packed part. This is not very restrictive, however, since any packed type is eventually equivalent to one-dimensional packed array. The number of unpacked dimensions is not restricted.

If a formal argument is specified as an open array with a range of its packed or one or more of its unpacked dimensions unspecified, then the actual argument shall match the formal one—regardless of its dimensions and sizes of its linearized packed or unpacked dimensions corresponding to an unspecified range of the formal argument, respectively.

Here are examples of types of formal arguments (empty square brackets [ ] denote open array):

```

logic
bit [8:1]
bit []
bit [7:0] array8x10 [1:10] // array8x10 is a formal arg name
logic [31:0] array32xN [] // array32xN is a formal arg name
logic [] arrayNx3 [3:1] // arrayNx3 is a formal arg name
bit [] arrayNxN [] // arrayNxN is a formal arg name

```

Example of complete import declarations:

```

import "DPI" function void foo(input logic [127:0]);
import "DPI" function void boo(logic [127:0] i []); // open array of 128-bit

```

The following example shows the use of open arrays for different sizes of actual arguments:

```

typedef struct {int i; ... } MyType;

import "DPI" function void foo(input MyType i [] []);
 /* 2-dimensional unsized unpacked array of MyType */

MyType a_10x5 [11:20] [6:2];
MyType a_64x8 [64:1] [-1:-8];

foo(a_10x5);
foo(a_64x8);

```

## 27.5 Calling imported functions

The usage of imported functions is identical as for native SystemVerilog functions., hence the usage and syntax for calling imported functions is identical as for native SystemVerilog functions. Specifically, arguments with default values can be omitted from the call; arguments can be passed by name, if all formal arguments are named.

## 27.5.1 Argument passing

Argument passing for imported functions is ruled by the *WYSIWYG* principle: *What You Specify Is What You Get*, see Section 27.5.1.1. The evaluation order of formal arguments follows general SystemVerilog rules.

Argument compatibility and coercion rules are the same as for native SystemVerilog functions. If a coercion is needed, a temporary variable is created and passed as the actual argument. For **input** and **inout** arguments, the temporary variable is initialized with the value of actual argument with the appropriate coercion; for **output** or **inout** arguments, the value of the temporary variable is assigned to the actual argument with the appropriate conversion. The assignments between a temporary and the actual argument follow general SystemVerilog rules for assignments and automatic coercion.

On the SystemVerilog side of the interface, the values of actual arguments for formal input arguments of imported functions shall not be affected by the callee; the initial values of formal output arguments of imported functions are unspecified (and can be implementation-dependent), and the necessary coercions, if any, are applied as for assignments. Imported functions shall not modify the values of their input arguments.

For the SystemVerilog side of the interface, the semantics of arguments passing is as if **input** arguments are passed by *copy-in*, **output** arguments are passed by *copy-out*, and **inout** arguments were passed by *copy-in*, *copy-out*. The terms *copy-in* and *copy-out* do not impose the actual implementation; they refer only to “hypothetical assignment”.

The actual implementation of argument passing is transparent to the SystemVerilog side of the interface. In particular, it is transparent to SystemVerilog whether an argument is actually passed by *value* or by *reference*. The actual argument passing mechanism is defined in the foreign language layer. See Annex E for more details.

### 27.5.1.1 “What You Specify Is What You Get” principle

The principle “What You Specify Is What You Get” guarantees the types of formal arguments of imported functions — an actual argument is guaranteed to be of the type specified for the formal argument, with the exception of open arrays (for which unspecified ranges are statically unknown). Formal arguments, other than open arrays, are fully defined by import declaration; they shall have ranges of packed or unpacked arrays exactly as specified in the import declaration. Only the declaration site of the imported function is relevant for such formal arguments.

Another way to state this is that no compiler (either C or SystemVerilog) can make argument coercions between a caller’s declared formal and the callee’s declared formals. This is because the callee’s formal arguments are declared in a different language than the caller’s formal arguments; hence there is no visible relationship between the two sets of formals. Users are expected to understand all argument relationships and provide properly matched types on both sides of the interface.

Formal arguments defined as open arrays have the size and ranges of the corresponding actual arguments, i.e., have the ranges of packed or unpacked arrays exactly as that of the actual argument. The unsized ranges of open arrays are determined at a call site; the rest of type information is specified at the import declaration.

So, if a formal argument is declared as `bit bit [15:8] b []`, then it is the import declaration which specifies the formal argument is an unpacked array of packed bit array with bounds 15 to 8, while the actual argument used at a particular call site defines the bounds for the unpacked part for that call.

LRM 242

## 27.5.2 Value changes for output and inout arguments

The SystemVerilog simulator is responsible for handling value changes for **output** and **inout** arguments. Such changes shall be detected and handled after control returns from imported functions to SystemVerilog code.

For **output** and **inout** arguments, the value propagation (i.e., value change events) happens as if an actual argument was assigned a formal argument immediately after control returns from imported functions. If there is more than one argument, the order of such assignments and the related value change propagation follows

general SystemVerilog rules.

## 27.6 Exported functions

DPI allows calling SystemVerilog functions from another language. However, such functions must adhere to the same restrictions on argument types and results as are imposed on imported functions. It is an error to export a function that does not satisfy such constraints.

SystemVerilog functions that can be called from foreign code need to be specified in **export** declarations. Export declarations are allowed to occur only in the scope in which the function being exported is defined. Only one export declaration per function is allowed in a given scope.

Note that class member functions cannot be exported, but all other SystemVerilog functions can be exported.

Similar to import declarations, **export** declarations can define an optional *c\_identifier* to be used in the foreign language when calling an exported function.

```
dpi_import_export ::= // from Annex A.2.6
 | export "DPI" [c_identifier =] function function_identifier ;
```

Syntax 27-2—DPI export declaration syntax (excerpt from Annex A)

*c\_identifier* is optional here. It defaults to *function\_identifier*. For rules describing *c\_identifier*, see Section 27.3. Note that all export functions are always context functions. No two functions in the same SystemVerilog scope can be exported with the same explicit or implicit *c\_identifier*. The export declaration and the definition of the corresponding SystemVerilog function can occur in any order. Only one export declaration is permitted per SystemVerilog function.

## 27.7 Exported tasks

LRM 132

SystemVerilog allows tasks to be called from a foreign language, similar to functions. Such tasks are termed “exported tasks”.

All aspects of exported functions described above in Section 27.6 apply to exported tasks. This includes legal declaration scopes as well as usage of the optional *c\_identifier*.

It is never legal to call an exported task from within an imported function. These semantics are identical to native SystemVerilog semantics, in which it is illegal for a function to perform a task enable.

It is legal for an imported task to call an exported task only if the imported task is declared with the **context** property. Section 27.4.3 (Context tasks and functions) for more details.

One difference between exported tasks and exported functions is that SystemVerilog tasks do not have return value types. The return value of an exported task is an int value which indicates if a disable is active or not on the current execution thread.

Similarly, imported tasks return an int value which is used to indicate that the imported task has acknowledged a disable. See Section 27.8 for more detail on disables in DPI.

## 27.8 Disabling DPI tasks and functions

LRM 132

It is possible for a **disable** statement to disable a block that is currently executing a mixed language call chain. When a DPI import task or function is disabled, the C code is required to follow a simple disable protocol. The protocol gives the C code the opportunity to perform any necessary resource cleanup, such as closing

open file handles, closing open VPI handles, or freeing heap memory.

An imported task or function is said to be in the disabled state when a **disable** statement somewhere in the design targets either it or a parent for disabling. Note that the only way for an imported task or function to enter the disabled state is immediately after the return of a call to an exported task or function. An important aspect of the protocol is that disabled import tasks and functions must programmatically acknowledge that they have been disabled. A task or function can determine that it is in the disabled state by calling the API function `svIsDisabledState()`.

The protocol is composed of the following items:

- 1) When an exported task returns due to a disable, it must return a value of 1. Otherwise it must return 0.
- 2) When an imported task returns due to a disable, it must return a value of 1. Otherwise it must return 0.
- 3) Before an imported function returns due to a disable, it must call the API function `svAckDisabledState()`.
- 4) Once an imported task or function enters the disabled state, it is illegal for the current function invocation to make any further calls to exported tasks or functions.

LRM 146

Items 2, 3, and 4 are mandatory behavior for imported DPI tasks and functions. It is the responsibility of the DPI programmer to correctly implement the behavior.

Item 1 is guaranteed by SystemVerilog simulators. In addition, simulators must implement checks to ensure that items 2, 3, and 4 are correctly followed by imported tasks and functions. If any protocol item is not correctly followed, a fatal simulation error is issued.

Note that if an exported task itself is the target of a disable, its parent imported task is not considered to be in the disabled state when the exported task returns. In such cases the exported task shall return value 0, and calls to `svIsDisabledState()` shall return 0 as well.

When a DPI imported task or function returns due to a disable, the values of its **output** and **inout** parameters are undefined. Similarly, function return values are undefined when an imported function returns due to a disable. C programmers can return values from disabled functions, and C programmers can write values into the locations of **output** and **inout** parameters of imported tasks or functions. However, SystemVerilog simulators are not obligated to propagate any such values to the calling SystemVerilog code if a disable is in effect.

## Section 28

# SystemVerilog Assertion API

This chapter defines the Assertion Application Programming Interface (API) in SystemVerilog.

### 28.1 Requirements

SystemVerilog provides assertion capabilities to enable:

- a user’s C code to react to assertion events.
- third-party assertion “waveform” dumping tools to be written.
- third-party assertion coverage tools to be written.
- third-party assertion debug tools to be written.

#### 28.1.1 Naming conventions

All elements added by this interface shall conform to the Verilog Procedural Interface (VPI) interface naming conventions.

- All names are prefixed by `vpi`.
- All *type names* shall start with `vpi`, followed by initially capitalized words with no separators, e.g., `vpiAssertCheck`.
- All callback names shall start with `cb`, followed by initially capitalized words with no separators, e.g., `cbAssertionStart`.
- All *function names* shall start with `vpi_`, followed by all lowercase words separated by underscores (`_`), e.g., `vpi_get_assert_info()`.

### 28.2 Extensions to VPI enumerations

These extensions shall be appended to the contents of the `vpi_user.h` file, described in IEEE Std. 1364-2001, Annex G. The numbers in the range 700 - 799 are reserved for the assertion portion of the VPI.

#### 28.2.1 Object types

This section lists the object type VPI calls. The VPI reserved range for these calls is 700 - 729.

```
#define vpiAssertion 700 /* assertion */
```

#### 28.2.2 Object properties

This section lists the object property VPI calls. The VPI reserved range for these calls is 700 - 729.

```
/* Assertion types */

#define vpiSequenceType 701
#define vpiAssertType 702
#define vpiCoverType 703
#define vpiPropertyType 704
#define vpiImmediateAssertType705
```

#### 28.2.3 Callbacks

This section lists the system callbacks. The VPI reserved range for these calls is 700 - 719.

1) Assertion

```
#define cbAssertionStart 700
#define cbAssertionSuccess 701
#define cbAssertionFailure 702
#define cbAssertionStepSuccess 703
#define cbAssertionStepFailure 704
#define cbAssertionDisable 705
#define cbAssertionEnable 706
#define cbAssertionReset 707
#define cbAssertionKill 708
```

2) “Assertion system”

```
#define cbAssertionSysInitialized709
#define cbAssertionSysStart 710
#define cbAssertionSysStop 711
#define cbAssertionSysEnd 712
#define cbAssertionSysReset 713
```

### 28.2.4 Control constants

This section lists the system control constant callbacks. The VPI reserved range for these calls is 730 - 759.

1) Assertion

```
#define vpiAssertionDisable 730
#define vpiAssertionEnable 731
#define vpiAssertionReset 732
#define vpiAssertionKill 733
#define vpiAssertionEnableStep 734
#define vpiAssertionDisableStep 735
```

2) Assertion stepping

```
#define vpiAssertionClockSteps 736
```

3) “Assertion system”

```
#define vpiAssertionSysStart 737
#define vpiAssertionSysStop 738
#define vpiAssertionSysEnd 739
#define vpiAssertionSysReset 740
```

## 28.3 Static information

This section defines how to obtain assertion handles and other static assertion information.

### 28.3.1 Obtaining assertion handles

SystemVerilog extends the VPI module iterator model (i.e., the instance) to encompass assertions, as shown in Figure 28-1.

The following steps highlight how to obtain the assertion handles for named assertions.

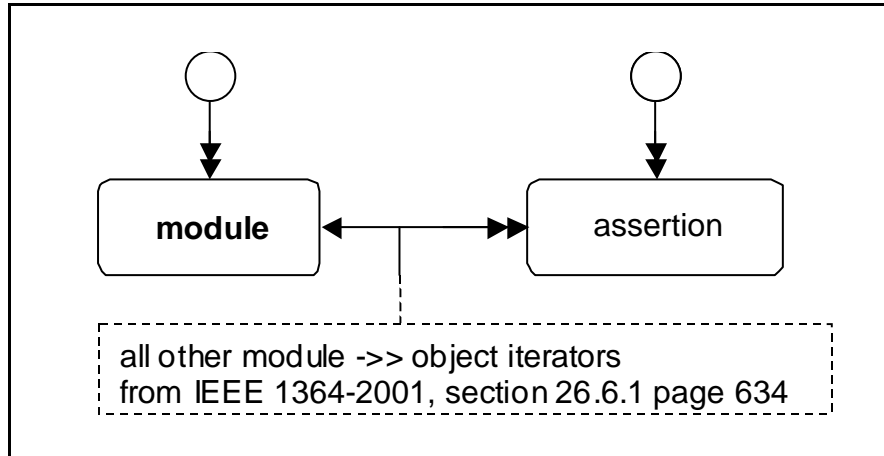

**Figure 28-1 — Encompassing assertions**

Note: Iteration on assertions from interfaces is not shown in Figure 28-1 since the interface object type is not currently defined in VPI. However the assertion API permits iteration on assertions from interface instance handles and obtaining static information on assertions used in interfaces (see Section 28.3.2.1).

- 1) Iterate all assertions in the design: use a NULL reference handle (ref) to `vpi_iterate()`, e.g.,

```
itr = vpi_iterate(vpiAssertion, NULL);
while (assertion = vpi_scan(itr)) {
 /* process assertion */
}
```

- 2) Iterate all assertions in an instance: pass the appropriate instance handle as a reference handle to `vpi_iterate()`, e.g.,

```
itr = vpi_iterate(vpiAssertion, instanceHandle);
while (assertion = vpi_scan(itr)) {
 /* process assertion */
}
```

- 3) Obtain the assertion by name: extend `vpi_handle_by_name` to also search for assertion names in the appropriate scope(s), e.g.,

```
vpiHandle = vpi_handle_by_name(assertName, scope)
```

- 4) To obtain an assertion of a specific type, e.g. cover assertions, the following approach should be used:

```
vpiHandle assertion;
itr = vpi_iterate(vpiAssertionType, NULL);
while (assertion = vpi_scan(itr)) {
 if (vpi_get(vpiAssertionType, assertion) == vpiCoverType) {
 /* process cover type assertion */
 }
}
```

#### NOTES

- 1—As with all VPI handles, assertion handles are handles to a specific instance of a specific assertion.
- 2—Unnamed assertions cannot be found by name.



### 28.3.2 Obtaining static assertion information

The following information about an assertion is considered to be static.

- Assertion name
- Instance in which the assertion occurs
- Module definition containing the assertion
- Assertion type
  - 1) Sequence
  - 2) Assert
  - 3) Cover
  - 4) Property
  - 5) ImmediateAssert
- Assertion source information: the file, line, and column where the assertion is defined.
- Assertion clocking block/expression

LRM 137

#### 28.3.2.1 Using `vpi_get_assertion_info`

Static information can be obtained directly from an assertion handle by using `vpi_get_assertion_info`, as shown below.

```
typedef struct t_vpi_source_info {
 PLI_BYTE8 *fileName;
 PLI_INT32 startLine;
 PLI_INT32 startColumn;
 PLI_INT32 endLine;
 PLI_INT32 endColumn;
} s_vpi_source_info, *p_vpi_source_info;
typedef struct t_vpi_assertion_info {
 PLI_BYTE8 *assertName; /* name of assertion */
 vpiHandle instance; /* instance containing assertion */
 PLI_BYTE8 defname; /* name of module/interface containing assertion */
 vpiHandle clock; /* clocking expression */
 PLI_INT32 assertionType; /* vpiSequenceType, vpiAssertType, vpiCoverType,
 /*
 /* vpiPropertyType, vpiImmediateAssertType */
 s_vpi_source_info sourceInfo;
} s_vpi_assertion_info, *p_vpi_assertion_info;
PLI_INT32 vpi_get_assertion_info (assert_handle, p_vpi_assertion_info);
```

LRM 121

This call obtains all the static information associated with an assertion.

The inputs are a valid handle to an assertion and a pointer to an existing `s_vpi_assertion_info` data structure. On success, the function returns `TRUE` and the `s_vpi_assertion_info` data structure is filled in as appropriate. On failure, the function returns `FALSE` and the contents of the assertion data structure are unpredictable.

Assertions can occur in modules and interfaces: for assertions defined in modules, the instance field in the `s_vpi_assertion_info` structure shall contain the handle to the appropriate module or interface instance. Note that VPI does not currently define the information model for interfaces and therefore the interface instance handle shall be implementation dependent. The clock field of that structure contains a handle to the event expression representing the clock for the assertion, as determined by Section 17.14.

NOTE: a single call returns all the information for efficiency reasons.

### 28.3.2.2 Extending `vpi_get()` and `vpi_get_str()`

In addition to `vpi_get_assertion_info`, the following existing VPI functions are also extended:

`vpi_get()`, `vpi_get_str()`

`vpi_get()` can be used to query the following VPI property from a handle to an assertion:

`vpiAssertionDirective`  
returns one of `vpiSequenceType`, `vpiAssertType`, `vpiCoverType`, `vpiPropertyType`, `vpiImmediateAssertType`.

`vpiLineNo`  
returns the line number where the assertion is declared.

`vpi_get_str()` can be used to obtain the following VPI properties from an assertion handle:

`vpiFileName`  
returns the filename of the source file where the assertion was declared.

`vpiName`  
returns the name of the assertion.

`vpiFullName`  
returns the fully qualified name of the assertion.

## 28.4 Dynamic information

This section defines how to place assertion system and assertion callbacks.

### 28.4.1 Placing assertion system callbacks

Use `vpi_register_cb()`, setting the `cb_rtn` element to the function to be invoked and the reason element of the `s_cb_data` structure to one of the following values, to place an assertion system callback.

`cbAssertionSysInitialized`  
occurs after the system has initialized. No assertion-specific actions can be performed until this callback completes. The assertion system can initialize before `cbStartOfSimulation` does or afterwards.

`cbAssertionSysStart`  
the assertion system has become active and starts processing assertion attempts. This always occur after `cbAssertionSysInitialized`. By default, the assertion system is “started” on simulation startup, but the user can delay this by using assertion system control actions.

`cbAssertionSysStop`  
the assertion system has been temporarily suspended. While stopped no assertion attempts are processed and no assertion-related callbacks occur. The assertion system can be stopped and resumed an arbitrary number of times during a single simulation run.

`cbAssertionSysEnd`  
occurs when all assertions have completed and no new attempts shall start. Once this callback occurs no more assertion-related callbacks shall occur and assertion-related actions shall have no further effect. This typically occurs after the end of simulation.

`cbAssertionSysReset`  
occurs when the assertion system is reset, e.g., due to a system control action.

The callback routine invoked follows the normal VPI callback prototype and is passed an `s_cb_data` containing the callback reason and any user data provided to the `vpi_register_cb()` call.

## 28.4.2 Placing assertions callbacks

Use `vpi_register_assertion_cb()` to place an assertion callback; the prototype is:

```

/* typedef for vpi_register_assertion_cb callback function */
typedef PLI_INT32 (vpi_assertion_callback_func)(
 PLI_INT32 reason, /* callback reason */
 vpiHandle cb_time, /* callback time */
 vpiHandle assertion, /* handle to assertion */
 vpiHandle p_vpi_attempt_info, /* attempt related information */
 PLI_BYTE8 *user_data /* user data entered upon registration */
);

vpiHandle vpi_register_assertion_cb(
 vpiHandle assertion, /* handle to assertion */
 PLI_INT32 reason, /* reason for which callbacks needed */
 vpi_assertion_callback_func *cb_rtn,
 PLI_BYTE8 *user_data /* user data to be supplied to cb */
);

typedef struct t_vpi_assertion_step_info {
 PLI_INT32 matched_expression_count;
 vpiHandle *matched_exprs; /* array of expressions */
 vpiHandle *p_vpi_source_info; /* array of source info */
 PLI_INT32 stateFrom, stateTo; /* identify transition */
} s_vpi_assertion_step_info, *p_vpi_assertion_step_info;
typedef struct t_vpi_attempt_info {
 union {
 vpiHandle failExpr;
 s_vpi_assertion_step_info step;
 } detail;
 PLI_REAL s_vpi_time_attemptStartTime; /* Time attempt triggered */
} s_vpi_attempt_info, *p_vpi_attempt_info;

```

LRM 181

LRM 121

LRM 181

where *reason* is any of the following.

`cbAssertionStart`

an assertion attempt has started. For most assertions one attempt starts each and every clock tick.

`cbAssertionSuccess`

when an assertion attempt reaches a success state.

`cbAssertionFailure`

when an assertion attempt fails to reach a success state.

`cbAssertionStepSuccess`

progress one step an attempt. By default, step callbacks are not enabled on any assertions; they are enabled on a per-assertion/per-attempt basis (see Section 28.5.2), rather than on a per-assertion basis.

`cbAssertionStepFailure`

failure to progress by one step along an attempt. By default, step callbacks are not enabled on any assertions; they are enabled on a per-assertion/per-attempt basis (see Section 28.5.2), rather than on a per-assertion basis.

`cbAssertionDisable`

whenever the assertion is disabled (e.g., as a result of a control action).

`cbAssertionEnable`

whenever the assertion is enabled.

`cbAssertionReset`

whenever the assertion is reset.

`cbAssertionKill`  
when an attempt is killed (e.g., as a result of a control action).

These callbacks are specific to a given assertion; placing such a callback on one assertion does not cause the callback to trigger on an event occurring on a different assertion. If the callback is successfully placed, a handle to the callback is returned. This handle can be used to remove the callback via `vpi_remove_cb()`. If there were errors on placing the callback, a `NULL` handle is returned. As with all other calls, invoking this function with invalid arguments has unpredictable effects.

Once the callback is placed, the user-supplied function shall be called each time the specified event occurs on the given assertion. The callback shall continue to be called whenever the event occurs until the callback is removed.

The callback function shall be supplied the following arguments:

- 1) the reason for the callback
- 2) a pointer to the time of the callback
- 3) the handle for the assertion
- 4) a pointer to an attempt information structure
- 5) a reference to the user data supplied when the callback was registered.

LRM 121

The `t_vpi_attempt_info` attempt information structure contains details relevant to the specific event that occurred.

LRM 181

- On disable, enable, reset and kill callbacks, the returned `p_vpi_attempt_info` info pointer is `NULL` and no attempt information is available.
- On start and success callbacks, only the `attemptStartTime` field is valid.
- On a `cbAssertionFailure` callback, the `attemptStartTime` and `detail.failExpr` fields are valid.
- On a step callback, the `attemptStartTime` and `detail.step` fields are valid.

On a step callback, the `detail` describes the set of expressions matched in satisfying a step along the assertion, along with the corresponding source references. In addition, the `step` also identifies the source and destination “states” needed to uniquely identify the path being taken through the assertion. *State ids* are just integers, with 0 identifying the origin state, 1 identifying an accepting state, and any other number representing some intermediate point in the assertion. It is possible for the number of expressions in a step to be 0 (zero), which represents an unconditional transition. In the case of a failing transition, the information provided is just as that for a successful one, but the last expression in the array represents the expression where the transition failed.

#### NOTES

- 1—In a failing transition, there shall always be at least one element in the expression array.
- 2—Placing a step callback results in the same callback function being invoked for both success and failure steps.
- 3—The content of the `cb_time` field depends on the reason identified by the reason field, as follows:

LRM 181

- `cbAssertionStart` — `cb_time` is the time when the assertion attempt has been started.
- `cbAssertionSuccess`, `cbAssertionFailure` — `cb_time` is the time when the assertion succeeded/failed.

- `cbAssertionStepSuccess`, `cbAssertionStepFailure` — `cb_time` is the time when the assertion attempt step succeeded/failed.
- `cbAssertionDisable`, `cbAssertionEnable`, `cbAssertionReset`, `cbAssertionKill` — `cb_time` is the time when the assertion attempt was disabled/enabled/reset/killed.

4—In contrast to `cb_time`, the content of `attemptStartTime` is always the start time of the actual attempt of an assertion. It can be used as a unique ID that distinguishes the attempts of any given assertion.

## 28.5 Control functions

This section defines how to obtain assertion system control and assertion control information.

### 28.5.1 Assertion system control

Use `vpi_control()`, with one of the following operators and no other arguments, to obtain assertion system control information.

Usage example: `vpi_control(vpiAssertionSysReset)`

`vpiAssertionSysReset`  
discards all attempts in progress for all assertions and restore the entire assertion system to its initial state. Any pre-existing `vpiAssertionStepSuccess` and `vpiAssertionStepFailure` callbacks shall be removed; all other assertion callbacks shall remain.

Usage example: `vpi_control(vpiAssertionSysStop)`

`vpiAssertionSysStop`  
considers all attempts in progress as unterminated and disable any further assertions from being started. This control has no effect on pre-existing assertion callbacks.

Usage example: `vpi_control(vpiAssertionSysStart)`

`vpiAssertionSysStart`  
restarts the assertion system after it was stopped (e.g., due to `vpiAssertionSysStop`). Once started, attempts shall resume on all assertions. This control has no effect on prior assertion callbacks.

Usage example: `vpi_control(vpiAssertionSysEnd)`

`vpiAssertionSysEnd`  
discard all attempts in progress and disables any further assertions from starting. All assertion callbacks currently installed shall be removed. Note that once this control is issued, no further assertion related actions shall be permitted.

### 28.5.2 Assertion control

Use `vpi_control()`, with one of the following operators, to obtain assertion control information.

- For the following operators, the second argument shall be a valid assertion handle.

Usage example: `vpi_control(vpiAssertionReset, assertionHandle)`

`vpiAssertionReset`  
discards all current attempts in progress for this assertion and resets this assertion to its initial state.

Usage example: `vpi_control(vpiAssertionDisable, assertionHandle)`

`vpiAssertionDisable`  
disables the starting of any new attempts for this assertion. This has no effect on any existing attempts. or if the assertion already disabled. By default, all assertions are enabled.

Usage example: `vpi_control(vpiAssertionEnable, assertionHandle)`

`vpiAssertionEnable`

enables starting new attempts for this assertion. This has no effect if assertion already enabled or on any existing attempts.

- For the following operators, the second argument shall be a valid assertion handle and the third argument shall be an attempt start-time (as a pointer to a correctly initialized `s_vpi_time` structure).

Usage example: `vpi_control(vpiAssertionKill, assertionHandle, attemptStartTime)`

LRM 121

`vpiAssertionKill`

discards the given attempts, but leaves the assertion enabled and does not reset any state used by this assertion (e.g., `past()` sampling).

Usage example: `vpi_control(vpiAssertionDisableStep, assertionHandle, attemptStartTime)`

`vpiAssertionDisableStep`

disables step callbacks for this assertion. This has no effect if stepping not enabled or it is already disabled.

- For the following operator, the second argument shall be a valid assertion handle, the third argument shall be an attempt start-time (as a pointer to a correctly initialized `s_vpi_time` structure) and the fourth argument shall be a step control constant.

Usage example: `vpi_control(vpiAssertionEnableStep, assertionHandle, attemptStartTime, vpiAssertionClockSteps)`

`vpiAssertionEnableStep`

enables step callbacks to occur for this assertion attempt. By default, stepping is disabled for all assertions. This call has no effect if stepping is already enabled for this assertion and attempt, other than possibly changing the stepping mode for the attempt if the attempt has not occurred yet. The stepping mode of any particular attempt cannot be modified after the assertion attempt in question has started.

NOTE—In this release, the only step control constant available is `vpiAssertionClockSteps`, indicating callbacks on a per assertion/clock-tick basis. The assertion clock is the event expression supplied as the clocking expression to the assertion declaration. The assertion shall “advance” whenever this event occurs and, when stepping is enabled, such events shall also cause step callbacks to occur.

## Section 29

# SystemVerilog Coverage API

### 29.1 Requirements

This chapter defines the Coverage Application Programming Interface (API) in SystemVerilog.

#### 29.1.1 SystemVerilog API

The following criteria are used within this API.

- 1) This API shall be similar for all coverages  
There are a wide number of coverage types available, with possibly different sets offered by different vendors. Maintaining a common interface across all the different types enhances portability and ease of use.
- 2) At a minimum, the following types of coverage shall be supported:
  - a) statement coverage
  - b) toggle coverage
  - c) fsm coverage
    - i) fsm states
    - ii) fsm transitions
  - c) assertion coverage
- 3) Coverage APIs shall be extensible in a transparent manner, i.e., adding a new coverage type shall not break any existing coverage usage.
- 4) This API shall provide means to obtain coverage information from specific sub-hierarchies of the design without requiring the user to enumerate all instances in those hierarchies.

#### 29.1.2 Naming conventions

All elements added by this interface shall conform to the Verilog Procedural Interface (VPI) interface naming conventions.

- All names are prefixed by `vpi`.
- All *type names* shall start with `vpi`, followed by initially capitalized words with no separators, e.g., `vpiCoverageStmt`.
- All *callback names* shall start with `cb`, followed by initially capitalized words with no separators, e.g., `cbAssertionStart`.
- All *function names* shall start with `vpi_`, followed by all lowercase words separated by underscores (`_`), e.g., `vpi_control()`.

#### 29.1.3 Nomenclature

The following terms are used in this standard.

*Statement coverage* — whether a statement has been executed or not, where *statement* is anything defined as a statement in the LRM. *Covered* means it executed at least once. Some implementations also permit

querying the execution count. The granularity of statement coverage can be per-statement or per-statement block (however defined).

*FSM coverage* — the number of states in a finite state machine (FSM) that this simulation reached. This standard does not require FSM automatic extraction, but a standard mechanism to force specific extraction is available via pragmas.

*Toggle coverage* — for each bit of every signal (wire and register), whether that bit has both a 0 value and a 1 value. *Full coverage* means both are seen; otherwise, some implementations can query for *partial coverage*. Some implementations also permit querying the toggle count of each bit.

*Assertion coverage* — for each assertion, whether it has had at least one success. Implementations permit querying for further details, such as attempt counts, success counts, failure counts and failure coverage.

These terms define the “primitives” for each coverage type. Over instances or blocks, the coverage number is merely the sum of all contained primitives in that instance or block.

## 29.2 SystemVerilog real-time coverage access

This section describes the mechanisms in SystemVerilog through which SystemVerilog code can query and control coverage information. Coverage information is provided to SystemVerilog by means of a number of built-in system functions (described in Section 29.2.2) using a number of predefined constants (described in Section 29.2.1) to describe the types of coverage and the control actions to be performed.

### 29.2.1 Predefined coverage constants in SystemVerilog

The following predefined ``defines` represent basic real-time coverage capabilities accessible directly from SystemVerilog.

— Coverage control

```
`define SV_COV_START 0
`define SV_COV_STOP 1
`define SV_COV_RESET 2
`define SV_COV_CHECK 3
```

LRM 120

— Scope definition (hierarchy traversal/accumulation type)

```
`define SV_COV_MODULE 10
`define SV_COV_HIER 11
```

— Coverage type identification

```
`define SV_COV_ASSERTION 20
`define SV_COV_FSM_STATE 21
`define SV_COV_STATEMENT 22
`define SV_COV_TOGGLE 23
```

— Status results

```
`define SV_COV_OVERFLOW -2
`define SV_COV_ERROR -1
`define SV_COV_NOCOV 0
`define SV_COV_OK 1
`define SV_COV_PARTIAL 2
```



## 29.2.2 Built-in coverage access system functions

### 29.2.2.1 \$coverage\_control

```
$coverage_control(control_constant,
 coverage_type,
 scope_def,
 modules_or_instance)
```

This function is used to control or query coverage availability in the specified portion of the hierarchy. The following control options are available:

LRM 120

``SV_COV_START`

If possible, starts collecting coverage information in the specified hierarchy. No effect if coverage is already being collected. Note that coverage is automatically started at the beginning of simulation for all portions of the hierarchy enabled for coverage.

``SV_COV_STOP`

Stops collecting coverage information in the specified hierarchy. No effect if coverage is not being collected.

``SV_COV_RESET`

Resets all available coverage information in the specified hierarchy. No effect if coverage not available.

``SV_COV_CHECK`

Checks if coverage information can be obtained from the specified hierarchy. Note the possibility of having coverage information does imply that coverage is being collected, as the coverage could have been stopped.

The return value is a ``define` name, with the value indicating the success of the action.

``SV_COV_OK`

On a check operation denotes that coverage is fully available in the specified hierarchy. For all other operations, represents successful and complete execution of the desired operation.

``SV_COV_ERROR`

On all operations means that the control operation failed without any effect, typically due to errors in arguments, such as a non-existing module.

``SV_COV_NOCOV`

On a check or start operation, denotes that coverage is not available at any point in the specified hierarchy.

``SV_COV_PARTIAL`

On a check or start operation, denotes that coverage is only partially available in the specified hierarchy.

The table below describes the possible return values for each of the coverage control options:

**Table 29-1: Coverage control return values**

|                            | <code>`SV_COV_OK</code> | <code>`SV_COV_ERROR</code> | <code>`SV_COV_NOCOV</code> | <code>`SV_COV_PARTIAL</code> |
|----------------------------|-------------------------|----------------------------|----------------------------|------------------------------|
| <code>`SV_COV_START</code> | success                 | bad args                   | no coverage                | partial coverage             |
| <code>`SV_COV_STOP</code>  | success                 | bad args                   | -                          | -                            |
| <code>`SV_COV_RESET</code> | success                 | bad args                   | -                          | -                            |
| <code>`SV_COV_CHECK</code> | full coverage           | bad args                   | no coverage                | partial coverage             |

Starting, stopping, or resetting coverage multiple times in succession for the same instance(s) has no further effect if coverage has already been started, stopped, or reset for that/those instance(s).

The hierarchy(ies) being controlled or queried are specified as follows.

```
`SV_MODULE_COV, "unique module def name"
```

provides coverage of all instances of the given module (the unique module name is a string), excluding any child instances in the instances of the given module. The module definition name can use special notation to describe nested module definitions.

```
`SV_COV_HIER, "module name"
```

provides coverage of all instances of the given module, including all the hierarchy below.

```
`SV_MODULE_COV, instance_name
```

provides coverage of the one named instance. The instance is specified as a normal Verilog hierarchical path.

```
`SV_COV_HIER, instance_name
```

provides coverage of the named instance, plus all the hierarchy below it.

All the permutations are summarized in Table 29-2.

**Table 29-2: Instance coverage permutations**

| Control/query               | “Definition name”                                                                                                          | instance.name                                                                                   |
|-----------------------------|----------------------------------------------------------------------------------------------------------------------------|-------------------------------------------------------------------------------------------------|
| <code>`SV_COV_MODULE</code> | The sum of coverage for all instances of the named module, excluding any hierarchy below those instances.                  | Coverage for just the named instance, excluding any hierarchy in instances below that instance. |
| <code>`SV_COV_HIER</code>   | The sum of coverage for all instances of the named module, including all coverage for all hierarchy below those instances. | Coverage for the named instance and any hierarchy below it.                                     |

NOTE—Definition names are represented as strings, whereas instance names are referenced by hierarchical paths. A hierarchical path need not include any `.` if the path refers to an instance in the current context (i.e., normal Verilog hierarchical path rules apply).

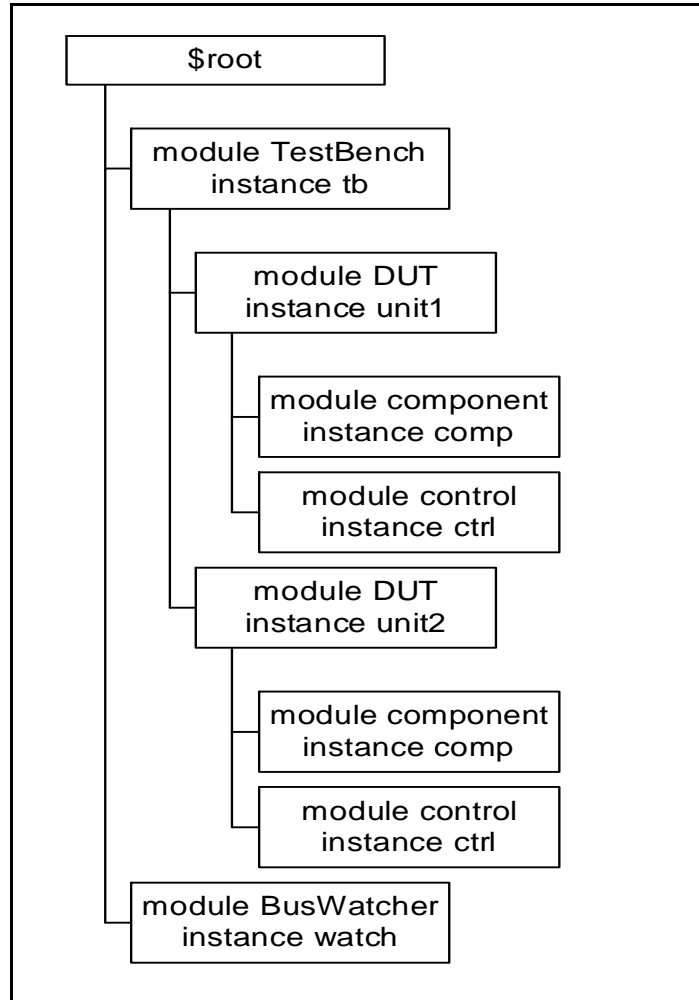

Example 29-1 — Hierarchical instance example

If coverage is enabled on all instances shown in Example 29-1 —, then:

```
$coverage_control(`SV_COV_CHECK, `SV_COV_TOGGLE, `SV_COV_HIER, $root)
```

checks all instances to verify they have coverage and, in this case, returns `SV\_COV\_OK.

```
$coverage_control(`SV_COV_RESET, `SV_COV_TOGGLE, `SV_COV_MODULE, "DUT")
```

resets coverage collection on both instances of the DUT, specifically, \$root.tb.unit1 and \$root.tb.unit2, but leaves coverage unaffected in all other instances.

```
$coverage_control(`SV_COV_RESET, `SV_COV_TOGGLE, `SV_COV_MODULE,
$root.tb.unit1)
```

resets coverage of only the instance \$root.tb.unit1, leaving all other instances unaffected.

```
$coverage_control(`SV_COV_STOP, `SV_COV_TOGGLE, `SV_COV_HIER,
$root.tb.unit1)
```

resets coverage of the instance \$root.tb.unit1 and also reset coverage for all instances below it, specifically \$root.tb.unit1.comp and \$root.tb.unit1.ctrl.

```
$coverage_control(`SV_COV_START, `SV_COV_TOGGLE, `SV_COV_HIER, "DUT")
```

starts coverage on all instances of the module DUT and of all hierarchy(ies) below those instances. In this

design, coverage is started for the instances `$root.tb.unit1`, `$root.tb.unit1.comp`, `$root.tb.unit1.ctrl`, `$root.tb.unit2`, `$root.tb.unit2.comp`, and `$root.tb.unit2.ctrl`.

### 29.2.2.2 \$coverage\_get\_max

```
$coverage_get_max(coverage_type, scope_def, modules_or_instance)
```

This function obtains the value representing 100% coverage for the specified coverage type over the specified portion of the hierarchy. This value shall remain constant across the duration of the simulation.

NOTE—This value is proportional to the design size and structure, so it also needs to be constant through multiple independent simulations and compilations of the same design, assuming any compilation options do not modify the coverage support or design structure.

The return value is an integer, with the following meanings.

-2 (``SV_COV_OVERFLOW`)

the value exceeds a number that can be represented as an integer.

-1 (``SV_COV_ERROR`)

an error occurred (typically due to using incorrect arguments).

0 (``SV_COV_NOCOV`)

no coverage is available for that coverage type on that/those hierarchy(ies).

+*pos\_num*

the maximum coverage number (where *pos\_num* > 0), which is the sum of all coverable items of that type over the given hierarchy(ies).

The scope of this function is specified as per `$coverage_control` (see Section 29.2.2.1).

### 29.2.2.3 \$coverage\_get

```
$coverage_get(coverage_type, scope_def, modules_or_instance)
```

This function obtains the current coverage value for the given coverage type over the given portion of the hierarchy. This number can be converted to a coverage percentage by use of the equation:

$$\text{coverage\%} = \frac{\text{coverage\_get}()}{\text{coverage\_get\_max}()} * 100$$

The return value follows the same pattern as `$coverage_get_max` (see Section 29.2.2.2), but with *pos\_num* representing the current coverage level, i.e., the number of the coverable items that have been covered in this/these hierarchy(ies).

The scope of this function is specified as per `$coverage_control` (see Section 29.2.2.1).

The return value is an integer, with the following meanings.

-2 (``SV_COV_OVERFLOW`)

the value exceeds a number that can be represented as an integer.

-1 (``SV_COV_ERROR`)

an error occurred (typically due to using incorrect arguments).

0 (``SV_COV_NOCOV`)

no coverage is available for that coverage type on that/those hierarchy(ies).

+*pos\_num*

the maximum coverage number (where *pos\_num* > 0), which is the sum of all coverable items of that type over the given hierarchy(ies).

#### 29.2.2.4 \$coverage\_merge

```
$coverage_merge(coverage_type, "name")
```

This function loads and merges coverage data for the specified coverage into the simulator. *name* is an arbitrary string used by the tool, in an *implementation-specific* way, to locate the appropriate coverage database, i.e., tools are allowed to store coverage files any place they want with any extension they want *as long* as the user can retrieve the information by asking for a specific saved name from that coverage database. If *name* does not exist or does not correspond to a coverage database from the same design, an error shall occur. If an error occurs during loading, the coverage numbers generated by this simulation might not be meaningful.

The return values from this function are:

```
\SV_COV_OK
the coverage data has been found and merged.

\SV_COV_NOCOV
the coverage data has been found, but did not contain the coverage type requested.

\SV_COV_ERROR
the coverage data was not found or it did not correspond to this design, or another error.
```

#### 29.2.2.5 \$coverage\_save

```
$coverage_save(coverage_type, "name")
```

This function saves the current state of coverage to the tool's coverage database and associates it with the given name. This name will be mapped in an implementation-specific way into some file or set of files in the coverage database. Data saved to the database shall be retrieved later by using `$coverage_merge` and supplying the same name. Saving coverage shall not have any effect on the state of coverage in this simulation.

LRM 120

The return values from this function are:

```
\SV_COV_OK
the coverage data was successfully saved.

\SV_COV_NOCOV
no such coverage is available in this design (nothing was saved).

\SV_COV_ERROR
some error occurred during the save. If an error occurs, the tool shall automatically remove the coverage database entry for name to preserve the coverage database integrity. It is not an error to overwrite a previously existing name.
```

#### NOTES

- 1—The coverage database format is implementation-dependent.
- 2—Mapping of names to actual directories/files is implementation-dependent. There is no requirement that a coverage name map to any specific set of files or directories.

### 29.3 FSM recognition

Coverage tools need to have automatic recognition of many of the common FSM coding idioms in Verilog/SystemVerilog. This standard does not attempt to describe or require any specific automatic FSM recognition mechanisms. However, the standard does prescribe a means by which non-automatic FSM extraction occurs. The presence of any of these standard FSM description additions shall override the tool's default extraction mechanism.

Identification of an FSM consists of identifying the following items:

- 1) the state register (or expression)
- 2) the next state register (this is optional)
- 3) the legal states.

### 29.3.1 Specifying the signal that holds the current state

Use the following pragma to identify the vector signal that holds the current state of the FSM:

```
/* tool state_vector signal_name */
```

where `tool` and `state_vector` are required keywords. This pragma needs to be specified inside the module definition where the signal is declared.

Another pragma is also required, to specify an enumeration name for the FSM. This enumeration name is also specified for the next state and any possible states, associating them with each other as part of the same FSM. There are two ways to do this:

- Use the same pragma:

```
/* tool state_vector signal_name enum enumeration_name */
```

- Use a separate pragma in the signal's declaration:

```
/* tool state_vector signal_name */
reg [7:0] /* tool enum enumeration_name */ signal_name;
```

In either case, `enum` is a required keyword; if using a separate pragma, `tool` is also a required keyword and the pragma needs to be specified immediately after the bit-range of the signal.

### 29.3.2 Specifying the part-select that holds the current state

A part-select of a vector signal can be used to hold the current state of the FSM. When a coverage tool displays or reports FSM coverage data, it names the FSM after the signal that holds the current state. If a part-select holds the current state in the user's FSM, the user needs to also specify a name for the FSM for the coverage tool to use. The FSM name is not the same as the enumeration name.

LRM 120

Specify the part-select by using the following pragma:

```
/* tool state_vector signal_name[n:n] FSM_name enum enumeration_name */
```

### 29.3.3 Specifying the concatenation that holds the current state

Like specifying a part-select, a concatenation of signals can be specified to hold the current state (when including an FSM name and an enumeration name):

```
/* tool state_vector {signal_name , signal_name, ...} FSM_name enum
enumeration_name */
```

The concatenation is composed of all the signals specified. Bit-selects or part-selects of signals cannot be used in the concatenation.

### 29.3.4 Specifying the signal that holds the next state

The signal that holds the next state of the FSM can also be specified with the pragma that specifies the enumeration name:

```
reg [7:0] /* tool enum enumeration_name */
signal_name
```

This pragma can be omitted if, and only if, the FSM does not have a signal for the next state.

### 29.3.5 Specifying the current and next state signals in the same declaration

The tool assumes the first signal following the pragma holds the current state and the next signal holds the next state when a pragma is used for specifying the enumeration name in a declaration of multiple signals, e.g.,

```
/* tool state_vector cs */
reg [1:0] /* tool enum myFSM */ cs, ns, nonstate;
```

In this example, the tool assumes signal `cs` holds the current state and signal `ns` holds the next state. It assumes nothing about signal `nonstate`.

### 29.3.6 Specifying the possible states of the FSM

The possible states of the FSM can also be specified with a pragma that includes the enumeration name:

```
parameter /* tool enum enumeration_name */
s0 = 0,
s1 = 1,
s2 = 2,
s3 = 3;
```

Put this pragma immediately after the keyword `parameter`, unless a bit-width for the parameters is used, in which case, specify the pragma immediately after the bit-width:

```
parameter [1:0] /* tool enum enumeration_name */
s0 = 0,
s1 = 1,
s2 = 2,
s3 = 3;
```

### 29.3.7 Pragmas in one-line comments

These pragmas work in both block comments, between the `/*` and `*/` character strings, and one-line comments, following the `//` character string, e.g.,

```
parameter [1:0] // tool enum enumeration_name
s0 = 0,
s1 = 1,
s2 = 2,
s3 = 3;
```

### 29.3.8 Example

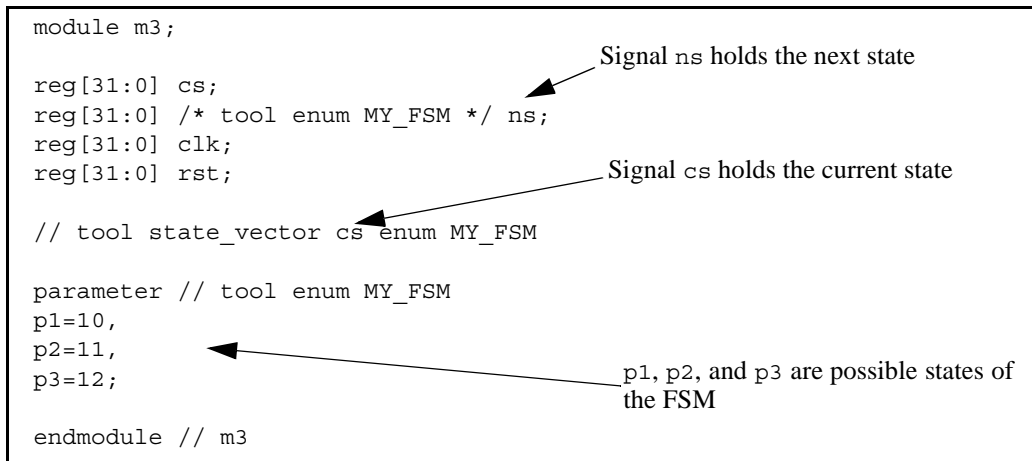

Example 29-2 — FSM specified with pragmas

## 29.4 VPI coverage extensions

### 29.4.1 VPI entity/relation diagrams related to coverage

### 29.4.2 Extensions to VPI enumerations

#### — Coverage control

```

#define vpiCoverageStart
#define vpiCoverageStop
#define vpiCoverageReset
#define vpiCoverageCheck
#define vpiCoverageMerge
#define vpiCoverageSave

```

#### — VPI properties

##### 1) Coverage type properties

```

#define vpiAssertCoverage
#define vpiFsmStateCoverage
#define vpiStatementCoverage
#define vpiToggleCoverage

```

##### 2) Coverage status properties

```

#define vpiCovered
#define vpiCoverMax
#define vpiCoveredCount

```

##### 3) Assertion-specific coverage status properties

```

#define vpiAssertAttemptCovered
#define vpiAssertSuccessCovered
#define vpiAssertFailureCovered

```

##### 4) FSM-specific methods



```
#define vpiFsmStates
#define vpiFsmStateExpression
```

— FSM handle types (vpi types)

```
#define vpiFsm
#define vpiFsmHandle
```

### 29.4.3 Obtaining coverage information

To obtain coverage information, the `vpi_get()` function is extended with additional VPI properties that can be obtained from existing handles:

```
vpi_get(<coverageType>, instance_handle)
```

Returns the number of covered items of the given coverage type in the given instance. Coverage type is one of the coverage type properties described in Section 29.4.2. For example, given coverage type `vpiStatementCoverage`, this call would return the number of covered statements in the instance pointed by `instance_handle`.

```
vpi_get(vpiCovered, assertion_handle)
vpi_get(vpiCovered, statement_handle)
vpi_get(vpiCovered, signal_handle)
vpi_get(vpiCovered, fsm_handle)
vpi_get(vpiCovered, fsm_state_handle)
```

Returns whether the item referenced by the handle has been covered. For handles that can contain multiple coverable entities, such as statement, fsm and signal handles, the return value indicates how many of the entities have been covered.

LRM 186

- For assertion handle, the coverable entities are assertions
- For statement handle, the entities are statements
- For signal handle, the entities are individual signal bits
- For fsm handle, the entities are fsm states

For assertions, `vpiCovered` implies that the assertion has been attempted, has succeeded at least once and has never failed. More detailed coverage information can be obtained for assertions by the following queries:

LRM 120

```
vpi_get(vpiAssertAttemptCovered, assertion_handle)
```

Returns the number of times the assertion has been attempted.

```
vpi_get(vpiAssertSuccessCovered, assertion_handle)
```

Returns the number of times the assertion has succeeded non-vacuously or, if assertion handle corresponds to a cover sequence, the number of times the sequence has been matched. Refer to Section 17.7.11 and 17.13 for the definition of vacuity.

```
vpi_get(vpiAssertVacuousSuccessCovered, assertion_handle)
```

Returns the number of times the assertion has succeeded vacuously. Refer to Section 17.7.11 and 17.13 for the definition of vacuity.

```
vpi_get(vpiAssertFailureCovered, assertion_handle)
```

Returns the number of times the assertion has failed. For any assertion, the number of attempts that have not yet reached any conclusion (success or failure) can be derived from the formula:

$\text{in progress} = \text{attempts} - (\text{successes} + \text{vacuous success} + \text{failures})$

The example below illustrates some of these queries:

```

module covtest;
 bit on = 1, off = 0;
 logic clk;

 initial begin
 clk = 0;
 forever begin
 #10;
 clk = ~clk;
 end
 end

 always @(false) begin
 anvr: assert(on ##1 on); // assertion will not be attempted
 end

 always @(posedge clk) begin
 aundf: assert (on ##[1:$] off); // assertion will not pass or fail
 afail: assert (on ##1 off); // assertion will always fail on 2nd tick
 apass: assert (on ##1 on); // assertion will succeed on each attempt
 end
endmodule

```

For this example, the assertions will have the following coverage results:

**Table 29-3: Assertion coverage results**

|       | vpiCovered | vpiAssertAttempt-Covered | vpiAssertSuccess-Covered | vpiAssertFailure-Covered |
|-------|------------|--------------------------|--------------------------|--------------------------|
| anvr  | false      | false                    | false                    | false                    |
| aundf | false      | true                     | false                    | false                    |
| afail | false      | true                     | false                    | true                     |
| apass | true       | true                     | true                     | false                    |

LRM 257

LRM 186

The number of times an item has been covered can be obtained by the vpiCoveredCount property:

```

vpi_get(vpiCoveredCount, assertion_handle)
vpi_get(vpiCoveredCount, statement_handle)
vpi_get(vpiCoveredCount, signal_handle)
vpi_get(vpiCoveredCount, fsm_handle)
vpi_get(vpiCoveredCount, fsm_state_handle)

```

Returns the number of times each coverable entity referred by the handle has been covered. Note that this is only easily interpretable when the handle points to a unique coverable item (such as an individual statement); when handle points to an item containing multiple coverable entities (such as a handle to a block statement containing a number of statements), the result is the sum of coverage counts for each of the constituent entities.

```

vpi_get(vpiCoveredMax, assertion_handle)
vpi_get(vpiCoveredMax, statement_handle)
vpi_get(vpiCoveredMax, signal_handle)
vpi_get(vpiCoveredMax, fsm_handle)
vpi_get(vpiCoveredMax, fsm_state_handle)

```

Returns the number of coverable entities pointed by the handle. Note that this shall always return 1 (one) when applied to an assertion or FSM state handle.

```
vpi_iterate(vpiFsm, instance-handle)
```

Returns an iterator to all FSMs in an instance.

```
vpi_handle(vpiFsmStateExpression, fsm-handle)
```

Returns the handle to the signal or expression encoding the FSM state.

```
vpi_iterate(vpiFsmStates, fsm-handle)
```

Returns an iterator to all states of an FSM.

```
vpi_get_value(fsm_state_handle, state-handle)
```

Returns the value of an FSM state.

#### 29.4.4 Controlling coverage

```
vpi_control(<coverageControl>, <coverageType>, instance_handle)
vpi_control(<coverageControl>, <coverageType>, assertion_handle)
```

Controls the collection of coverage on the given instance or assertion. Note that statement, toggle and FSM coverage are not individually controllable (i.e., they are controllable only at the instance level and not on a per statement/signal/FSM basis). The semantics and behavior are as per the `$coverage_control` system function (see Section 29.2.2.1). *coverageControl* is one `vpiCoverageStart`, `vpiCoverageStop`, `vpiCoverageReset` or `vpiCoverageCheck`, as defined in Section 29.4.2. *coverageType* is any one of the VPI coverage type properties (Section 29.4.2)

```
vpi_control(<coverageControl>, <coverageType>, name)
```

This saves or merges coverage into the current simulation. The semantics and behavior are specified as per the equivalent system functions `$coverage_merge` (see Section 29.2.2.4) and `$coverage_save` (see Section 29.2.2.5). *coverageControl* is one of `vpiCoverageMerge` or `vpiCoverageSave`, defined in Section 29.4.2.

## Section 30

# SystemVerilog Data Read API

LRM 182

### 30.1 Introduction (informative)

This chapter extends the SystemVerilog VPI with read facilities so that the Verilog Procedural Interface (VPI) acts as an Application Programming Interface (API) for data access and tool interaction irrespective of whether the data is in memory or a persistent form such as a database, and also irrespective of the tool the user is interacting with.

SystemVerilog is both a design and verification language consequently its VPI has a wealth of design and verification data access mechanisms. This makes the VPI an ideal vehicle for tool integration in order to replace arcane, inefficient, and error-prone file-based data exchanges with a new mechanism for tool to tool, and user to tool interface. Moreover, a single access API eases the interoperability investments for vendors and users alike. Reducing interoperability barriers allows vendors to focus on tool implementation. Users, on the other hand, are able to create integrated design flows from a multitude of best-in-class offerings spanning the realms of design and verification such as simulators, debuggers, formal, coverage or test bench tools.

### 30.2 Requirements

SystemVerilog adds several design and verification constructs including:

- C data types such as `int`, `struct`, `union`, and `enum`.
- Advanced built-in data types such as `string`.
- User defined data types and corresponding methods.
- Data types and facilities that enhance the creation and functionality of testbenches.

The access API shall be implemented by all tools as a minimal set for a standard means for user-tool or tool-tool interaction that involves SystemVerilog object data querying (reading). In other words, there is no need for a simulator to be running for this API to be in effect; it is a set of API routines that can be used for any interaction for example between a user and a waveform tool to *read* the data stored in its database. This usage flow is shown in the figure below.

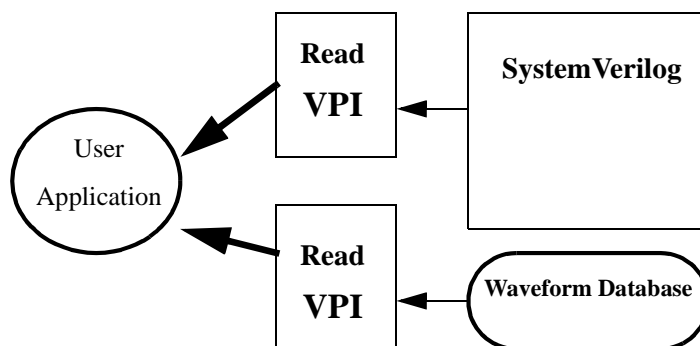

Figure 30-2 — Data read VPI usage model

Our focus in the API is the user view of access. While the API does provide varied facilities to give the user the ability to effectively architect his or her application, it does not address the tool level efficiency concerns such as time-based incremental load of the data, and/or predicting or learning the user access. It is left up to implementors to make this as easy and seamless as possible on the user. To make this easy on tools, the API provides an initialization routine where the user specifies access type and design scope. The user should be pri-

marily concerned with the API specified here, and efficiency issues are dealt with behind the scenes.

### 30.3 Extensions to VPI enumerations

These extensions shall be appended to the contents of the `vpi_user.h` file, described in IEEE Std. 1364-2001, Annex G. The numbers in the range **800 - 899** are reserved for the read data access portion of the VPI.

#### 30.3.1 Object types

All objects in VPI have a `vpiType`. This API adds a new object type for data traversal, and two other objects types for object collection and traverse object collection.

```
/* vpiHandle type for the data traverse object */
#define vpiTrvsObj 800 /* use in vpi_handle() */
#define vpiCollection 810 /* Collection of VPI handles */
#define vpiObjCollection 811 /* Collection of traversable
 design objs */
#define vpiTrvsCollection 812 /* Collection of vpiTrvsObj's */
```

The other object types that this API references, for example to get a value at a specific time, are all the valid types in the VPI that can be used as arguments in the VPI routines for logic and strength value processing such as `vpi_get_value(<object_handle>, <value_pointer>)`. These types include:

- Constants
- Nets and net arrays
- Regs and reg arrays
- Variables
- Memory
- Parameters
- Primitives
- Assertions

In other words, any limitation in `vpiType` of `vpi_get_value()` shall also be reflected in this data access API.

#### 30.3.2 Object properties

This section lists the object property VPI calls.

##### 30.3.2.1 Static info

```
/* Check */
/* use in vpi_get() */
#define vpiIsLoaded 820 /* is loaded */
#define vpiHasDataVC 821 /* has at least one VC
 at some point in time
 in the database */
#define vpiHasVC 822 /* has VC at specific
 time */
#define vpiHasNoValue 823 /* has no value at
 specific time */
#define vpiBelong 824 /* belong to extension */
```

```

/* Access */
#define vpiAccess LimitedInteractive 830 /* interactive */
#define vpiAccessInteractive 831 /* interactive: history */
#define vpiAccessPostProcess 832 /* database */

/* Member of a collection */
#define vpiMember 840 /* use in vpi_iterate() */
/* Iteration on instances for loaded */
#define vpiDataLoaded 850 /* use in vpi_iterate() */

```

### 30.3.2.2 Dynamic info

#### 30.3.2.2.1 Control constants

```

/* Control Traverse: use in vpi_goto() for a vpiTrvsObj type */
#define vpiMinTime 860 /* min time */
#define vpiMaxTime 864 /* max time */
#define vpiPrevVC 868
#define vpiNextVC 870
#define vpiTime 874 /* time jump */

```

These properties can also be used in `vpi_get_time()` to enhance the access efficiency. The routine `vpi_get_time()` with a traverse handle argument is extended with the additional ability to get the min, max, previous VC, and next VC times of the traverse handle; not just the current time of the handle. These same control constants can then be used for both access and for moving the traverse handle where the context (get or go to) can distinguish the intent.

### 30.3.3 System callbacks

The access API adds no new system callbacks. The reader routines (methods) can be called whenever the user application has control and wishes to access data.

## 30.4 VPI object type additions

### 30.4.1 Traverse object

To access the value changes of an object over time, the notion of a Value Change (VC) traverse handle is added. A value change traverse object is used to traverse and access value changes not just for the current value (as calling `vpi_get_time()` or `vpi_get_value()` on the object handle would) but for any point in time: past, present, or future. To create a value change traverse handle the routine `vpi_handle()` is called with a `vpiTrvsObj vpiType`:

```

vpiHandle object_handle; /* design object */
vpiHandle trvsHndl = vpi_handle(/*vpiType*/vpiTrvsObj,
 /*vpiHandle*/ object_handle);

```

A traverse object exists from the time it is created until its handle is released. It is the application's responsibility to keep a handle to the created traverse object, and to release it when it is no longer needed.

### 30.4.2 VPI Collection

In order to read data efficiently, it can be necessary to specify a group of objects. For example, when traversing data a user might wish to specify a list of objects to be marked as targets of data traversal. To do this grouping requires the notion of a collection. A collection represents a user-defined collection of VPI handles. The collection is an ordered list of VPI handles. The `vpiType` of a collection handle can be `vpiCollection`, `vpiObjCollection`, or `vpiTrvsCollection`:

- A collection of type `vpiCollection` is a general collection of VPI handles of objects of any type.
- The collection object of type `vpiObjCollection` represents a collection of VPI traversable objects in the design.
- A `vpiTrvsCollection` is a collection of traverse objects of type `vpiTrvsObj`.

Our usage here in the read API is of either:

- Collections of traversable design objects: Used for example in `vpi_handle()` to create traverse handles for the collection. A collection of traversable design objects is of type `vpiObjCollection` (the elements can be any object type in the design except traverse objects of type `vpiTrvsObj`).
- Collections of data traverse objects: Used for example in `vpi_goto()` to move the traverse handles of all the objects in the collection (all are of type `vpiTrvsObj`). A collection of traverse objects is a `vpiTrvsCollection`.

The collection contains a set of member VPI objects and can take on an arbitrary size. The collection can be created at any time and existing objects can be added to it. The reader implementation can perform a type check on the items being added to the collection and generate an error if the item added does not belong to the allowed `vpiType`.

The purpose of a collection is to group design objects and permit operating on each element with a single operation applied to the whole collection group. `vpi_iterate(vpiMember, <collection_handle>)` is used to create a member iterator. `vpi_scan()` can then be used to scan the iterator for the elements of the collection.

A collection object is created with `vpi_create()`. The first call provides `NULL` handles to the collection object and the object to be added. Following calls, which can be performed at any time, provide the collection handle and a handle to the object for addition. The return argument is a handle to the collection object.

For example:

```
vpiHandle designCollection;
vpiHandle designObj;
vpiHandle trvsCollection;
vpiHandle trvsObj;
/* Create a collection of design objects */
designCollection = vpi_create(vpiObjCollection, NULL, NULL);
/* Add design object designObj into it */
designCollection = vpi_create(vpiObjCollection, designCollection, designObj);

/* Create a collection of traverse objects*/
trvsCollection = vpi_create(vpiTrvsCollection, NULL, NULL);
/* Add traverse object trvsObj into it */
trvsCollection = vpi_create(vpiTrvsCollection, trvsCollection, trvsObj);
```

Sometimes it is necessary to filter a collection and extract a set of handles which meet, or do not meet, a specific criterion for a given collection. The function `vpi_filter()` can be used for this purpose in the form of:

```
vpiHandle colFilterHdl = vpi_filter((vpiHandle) colHdl, (PLI_INT32)
 filterType, (PLI_INT32) flag);
```

The first argument of `vpi_filter()`, `colHdl`, shall be the collection on which to apply the filter operation. The second argument, `filterType` can be any `vpiType` or VPI boolean property. This argument is the criterion used for filtering the collection members. The third argument, `flag`, is a boolean value. If set to `TRUE`, `vpi_filter()` shall return a collection of handles which match the criterion indicated by `filterType`, if set to `FALSE`, `vpi_filter()` shall return a collection of handles which do not match the criterion indicated by `filterType`. The original collection passed as a first argument remains unchanged.

A collection object exists from the time it is created until its handle is released. It is the application's responsibility to keep a handle to the created collection, and to release it when it is no longer needed.

#### 30.4.2.1 Operations on collections

A traverse collection can be obtained (i.e. created) from a design collection using `vpi_handle()`. The call would take on the form of:

```
vpiHandle objCollection;
/* Obtain a traverse collection from the object collection */
vpi_handle(vpiTrvsCollection, objCollection);
```

The usage of this capability is discussed in Section 30.8.7.

| Another optional method is defined, which is used in the case the user wishes to directly control the data load, for loading data of objects in a collection: `vpi_load()`. This operation loads all the objects in the collection. It is equivalent to performing a `vpi_load()` on every single handle of the object elements in the collection.

| A traversal method is also defined on collections of traverse handles; i.e. collections of type `vpiTrvsCollection`. The method is `vpi_goto()`.

### 30.5 Object model diagrams

A traverse object of type `vpiTrvsObj` is related to its parent object; it is a means to access the value data of said object. An object can have several traverse objects each pointing and moving in a different way along the value data horizon. This is shown graphically in the model diagram below. The traversable class is a representational grouping consisting of any object that:

- Has a name
- Can take on a value accessible with `vpi_get_value()`, the value must be variable over time (i.e. necessitates creation of a traverse object to access the value over time).

The class includes nets, net arrays, regs, reg arrays, variables, memory, primitive, primitive arrays, concurrent assertions, and parameters. It also includes part selects of all the design object types that can have part selects.



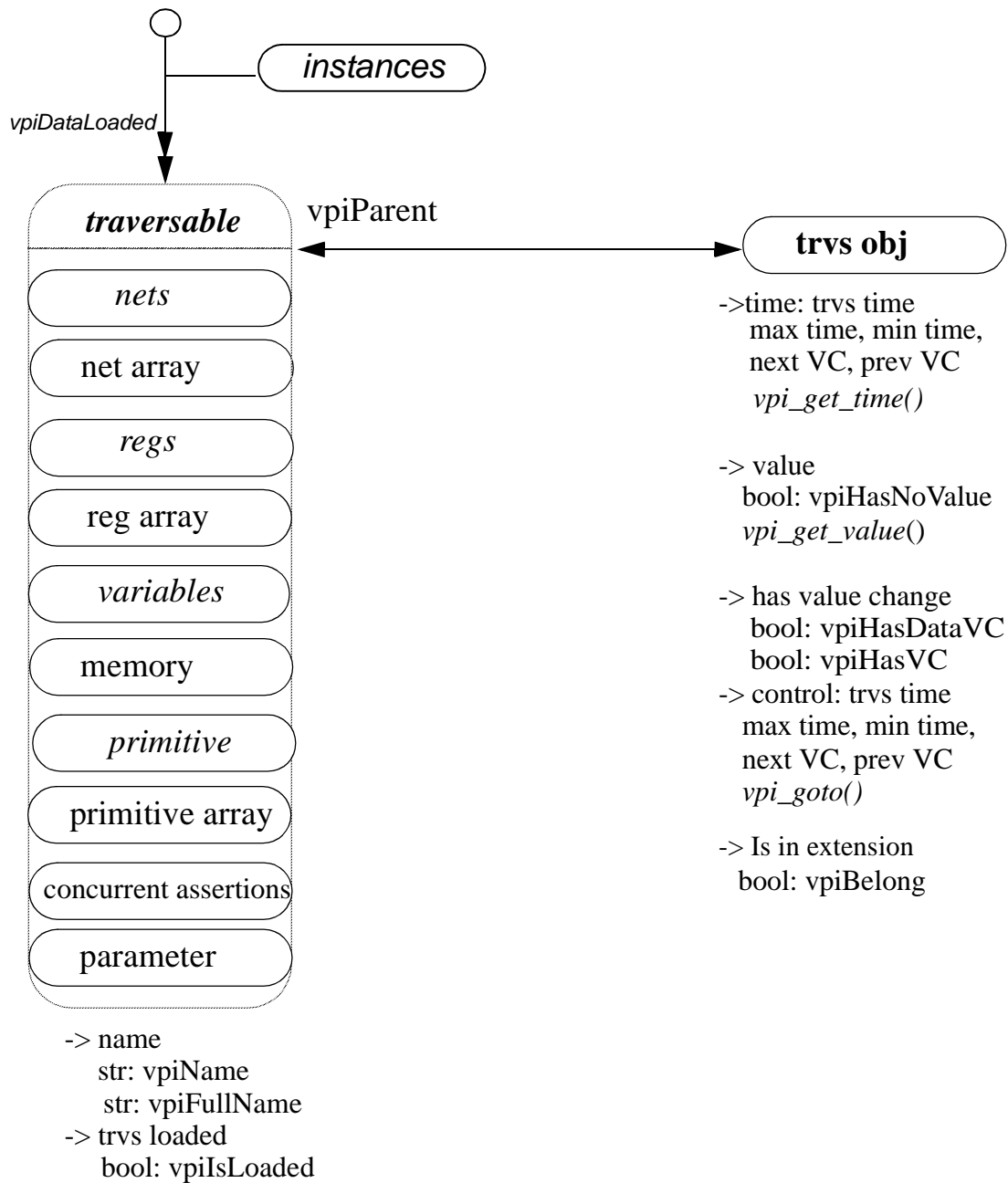

**Figure 30-3 — Model diagram of traverse object**

A collection object of type *vpiObjCollection* groups together a set of design objects *Obj* (of any type). A traverse collection object of type *vpiTrvsCollection* groups together a set of traverse objects *trvsObj* of type *vpiTrvsObj*.

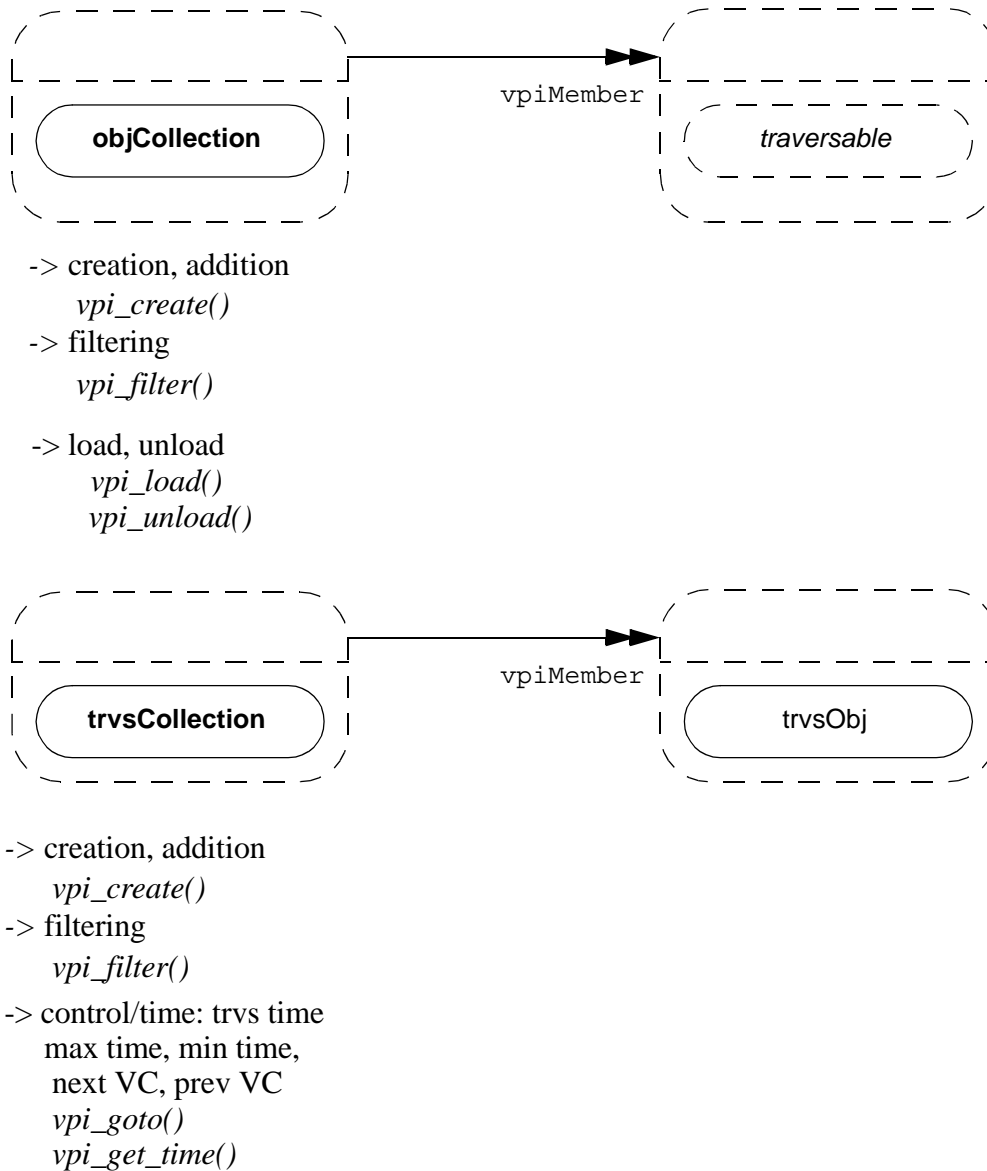

Figure 30-4 — Model diagram of collection

### 30.6 Usage extensions to VPI routines

Several VPI routines, that have existed before SystemVerilog, have been extended in usage with the addition of new object types and/or properties. While the extensions are fairly obvious, they are emphasized here again to turn the reader's attention to the extended usage.

**Table 30-1: Usage extensions to Verilog 2001 VPI routines**

| To                                                                                                                                                                                                                                    | Use                              | New Usage                                                                                                                                                                                      |
|---------------------------------------------------------------------------------------------------------------------------------------------------------------------------------------------------------------------------------------|----------------------------------|------------------------------------------------------------------------------------------------------------------------------------------------------------------------------------------------|
| Get tool's reader version                                                                                                                                                                                                             | <code>vpi_get_vlog_info()</code> | Reader version information                                                                                                                                                                     |
| Create an iterator for the loaded objects (using <code>vpi_iterate(vpiDataLoaded, &lt;instance&gt;)</code> ). Create an iterator for (object or traverse) collections using <code>vpi_iterate(vpiMember, &lt;collection&gt;)</code> . | <code>vpi_iterate()</code>       | Add iteration types <code>vpiDataLoaded</code> and <code>vpiMember</code> . Extended with collection handle to create a collection member element iterator.                                    |
| Obtain a traverse (collection) handle from an object (collection) handle                                                                                                                                                              | <code>vpi_handle()</code>        | Add new types <code>vpiTrvsObj</code> and <code>vpiTrvsCollection</code> . Extended with collection handle (of traversable objects) to create a traverse collection from an object collection. |
| Obtain a property.                                                                                                                                                                                                                    | <code>vpi_get()</code>           | Extended with the new check properties: <code>vpiIsLoaded</code> , <code>vpiHasDataVC</code> , <code>vpiHasVC</code> , <code>vpiHasNoValue</code> , and <code>vpiBelong</code> .               |
| Get a value.                                                                                                                                                                                                                          | <code>vpi_get_value()</code>     | Use traverse handle as argument to get value where handle points.                                                                                                                              |
| Get time traverse (collection) handle points at.                                                                                                                                                                                      | <code>vpi_get_time()</code>      | Use traverse (collection) handle as argument to get current time where handle points. Also, get the traverse handle min, max, previous VC time, or next VC time.                               |
| Free traverse handle<br>Free (traverse) collection handle.                                                                                                                                                                            | <code>vpi_free_object()</code>   | Use traverse handle as argument<br>Use (traverse) collection handle as argument.                                                                                                               |

### 30.7 VPI routines added in SystemVerilog

This section lists all the VPI routines added in SystemVerilog.

**Table 30-2: VPI routines**

| To                                                                                                                                                                                                                                                                                                                     | Use                               |
|------------------------------------------------------------------------------------------------------------------------------------------------------------------------------------------------------------------------------------------------------------------------------------------------------------------------|-----------------------------------|
| For the reader extension, initialize read interface by loading the appropriate reader extension library (simulator, waveform, or other tool). All VPI routines defined by the reader extension library shall be called by indirection through the returned pointer; only built-in VPI routines can be called directly. | <code>vpi_load_extension()</code> |

**Table 30-3: Reader VPI routines**

| To                                                                                                                                                          | Use                          |
|-------------------------------------------------------------------------------------------------------------------------------------------------------------|------------------------------|
| Perform any tool cleanup. Close database (if opened in <code>vpiAccessPostProcess</code> or <code>vpiAccessInteractive</code> mode).                        | <code>vpi_close()</code>     |
| Create a new handle: used to<br>- create an object (traverse) collection<br>- Add a (traverse) object to an existing collection.                            | <code>vpi_create()</code>    |
| Filter a collection and extract a set of handles which meet, or do not meet, a specific criterion for a given collection.                                   | <code>vpi_filter()</code>    |
| Move traverse (collection) to min, max, or specific time. Return a new traverse (collection) handle containing all the objects that have a VC at that time. | <code>vpi_goto()</code>      |
| Load data (for a single design object or a collection) onto memory if the user wishes to exercise this level of data load control.                          | <code>vpi_load()</code>      |
| Initialize load access.                                                                                                                                     | <code>vpi_load_init()</code> |
| Unload data (for a single design object or a collection) from memory if the user wishes to exercise this level of data load control.                        | <code>vpi_unload()</code>    |

### 30.8 Reading data

Reading data is performed in 3 steps:

- 1) A design object must be *selected* for traverse access from a database (or from memory).
- 2) Indicate the intent to access data. This is typically done by a `vpi_load_init()` call as a hint from the user to the tool on which areas of the design are going to be accessed. The tool shall then load the data in an invisible fashion to the user (for example, either right after the call, or at traverse handle creation, or usage). Alternatively, if the user wishes he can (also) choose to add a specific `vpi_load()` call (this can be done at any point in time) to load, or force the load of, a specific object or collection of objects. This can

be done either instead of, or in addition to, the objects in the scope or collection specified in `vpi_load_init()`. `vpi_unload()` can be used by the user to force the tool to unload specific objects. It should be noted that traverse handle creation shall fail for unloaded objects or collections.

- 3) Once an object is selected, and marked for load, a traverse object handle can be created and used to traverse the design objects' stored data.
- 4) At this point the object is available for reading. The traverse object permits the data value traversal and access.

### 30.8.1 VPI read initialization and load access initialization

Selecting an object is done in 3 steps:

- 1) The first step is to initialize the read access with a call to `vpi_load_extension()` to load the reader extension and set:
  - a) Name of the reader library to be used specified as a character string. This is either a full pathname to this library or the single filename (without path information) of this library, assuming a vendor specific way of defining the location of such a library. The latter method is more portable and therefore recommended. Neither the full pathname, nor the single filename shall include an extension, the name of the library must be unique and the appropriate extension for the actual platform should be provided by the application loading this library. More details are in Section 30.10.
  - b) Name of the database holding the stored data or flush database in case of `vpiAccessPostProcess` or `vpiAccessInteractive` respectively; a `NULL` can be used in case of `vpiAccessLimitedInteractive`. This is the logical name of a database, not the name of a file in the file system. It is implementation dependent whether there is any relationship to an actual on-disk object and the provided name. See access mode below for more details on the access modes.
  - c) Access mode: The following VPI properties set the mode of access
    - `vpiAccessLimitedInteractive`: Means that the access shall be done for the data stored in the tool memory (e.g. simulator), the history (or future) that the tool stores is implementation dependent. If the tool does not store the requested info then the querying routines shall return a fail. The database name argument to `vpi_load_extension()` in this mode shall be ignored (even if not `NULL`).
    - `vpiAccessInteractive`: Means that the access shall be done interactively. The tool shall then use the database specified as a “flush” area for its data. This mode is very similar to the `vpiAccessLimitedInteractive` with the additional requirement that all the past history (before current time) shall be stored (for the specified scope/collection, see the access scope/collection description of `vpi_load_init()`).
    - `vpiAccessPostProcess`: Means that the access shall be done through the specified database. All data queries shall return the data stored in the specified database. Data history depends on what is stored in the database, and can be nothing (i.e. no data).

`vpi_load_extension()` can be called multiple times for different reader interface libraries (coming from different tools), database specification, and/or read access. A call with `vpiAccessInteractive` means that the user is querying the data stored inside the simulator database and uses the VPI routines supported by the simulator. A call with `vpiAccessPostProcess` means that the user is accessing the data stored in the database and uses the VPI services provided by the waveform tool. The application, if accessing several databases and/or using multiple read API libraries, can use the routine `vpi_get(vpiBelong, <vpiHandle>)` to check whether a handle belongs to that database. The call is performed as follows:

```
reader_extension_ptr->vpi_get(vpiBelong, <vpiHandle>);
```

where `reader_extension_ptr` is the reader library pointer returned by the call to

`vpi_load_extension()`. `TRUE` is returned if the passed handle belongs to that extension, and `FALSE` otherwise. If the application uses the built-in library (i.e. the one provided by the tool it is running under), there is no need to use indirection to call the VPI routines; they can be called directly. An initial call must however be made to set the access mode, specify the database, and check for error indicated by a `NULL` return.

`vpi_close()` shall be called in case of:

- `vpiAccessLimitedInteractive` to perform any tool cleanup. The validity of VPI handles after this call is left up to the particular reader implementation.
- `vpiAccessPostProcess` or `vpiAccessInteractive` mode to perform any tool cleanup and close the opened database. Handles obtained before the call to `vpi_close()` are no longer valid after this call.

Multiple databases, possibly in different access modes (for example a simulator database opened in `vpiAccessInteractive` and a database opened in `vpiAccessPostProcess`, or two different databases opened in `vpiAccessPostProcess`) can be accessed at the same time. Section 30.10 shows an example of how to access multiple databases from multiple read interfaces simultaneously.

2) Next step is to specify the elements that shall be accessed. This is accomplished by calling `vpi_load_init()` and specifying a scope and/or an item collection. At least one of the two (scope or collection) needs to be specified. If both are specified then the union of all the object elements forms the entire set of objects the user can access.

- Access scope: The specified scope handle, and nesting mode govern the scope that access returns. Data queries outside this scope (and its sub-scopes as governed by the nesting mode) shall return a fail in the access routines unless the object belongs to *access collection* described below. It can be used either in a complementary or in an exclusive fashion to *access collection*. `NULL` is to be passed to the collection when *access scope* is used in an exclusive fashion.
- Access collection: The specified collection stores the traverse object handles to be loaded. It can be used either in a complementary or in an exclusive fashion to *access scope*. `NULL` is to be passed to the scope when *access collection* is used in an exclusive fashion.

`vpi_load_init()` enables access to the objects stored in the database and can be called multiple times. The load access specification of a call remains valid until the next call is executed. This routine serves to initialize the tool load access and provides an entry point for the tool to perform data access optimizations.

### 30.8.2 Object selection for traverse access

In order to select an object for access, the user must first obtain the object handle. This can be done using the VPI routines (that are supported in the tool being used) for traversing the HDL hierarchy and obtaining an object handle based on the type of object relationship to another (top) handle.

Any tool that implements this read API (e.g. waveform tool) shall implement at least a basic subset of the design navigation VPI routines that shall include `vpi_handle_by_name()` to permit the user to get a `vpiHandle` from an object name. It is left up to tool implementation to support additional design navigation relationships. Therefore, if the application wishes to access similar elements from one database to another, it shall use the name of the object, and then call `vpi_handle_by_name()`, to get the object handle from the relevant database. This level of indirection is always safe to do when switching the database query context, and shall be guaranteed to work.

It should be noted that an object's `vpiHandle` depends on the access mode specified in `vpi_load_extension()` and the database accessed (identified by the returned extension pointer, see Section 30.10). A handle obtained through a post process access mode (`vpiAccessPostProcess`) from a waveform tool for example is not interchangeable in general with a handle obtained through interactive access mode (`vpiAccessLimitedInteractive` or `vpiAccessInteractive`) from a simulator. Also handles obtained through post process access mode of different databases are not interchangeable. This is because objects, their data, and relationships in a stored database could be quite different from those in the simulation model, and

those in other databases.

### 30.8.3 Optionally loading objects

As mentioned earlier, `vpi_load_init()` allows the tool implementing the reader to load objects in a fashion that is invisible to the user. Optionally, if the user chooses to do their own loading at some point in time, then once the object handle is obtained they can use the VPI data load routine `vpi_load()` with the object's `vpiHandle` to load the data for the specific object onto memory. Alternatively, for efficiency considerations, `vpi_load()` can be called with a design object collection handle of type `vpiObjCollection`. The collection must have already been created with `vpi_create()` and the (additional) selected object handles added to the load collection using `vpi_create()` with the created collection list passed as argument. The object(s) data is not accessible as of yet to the user's read queries; a traverse handle must still be created. This is presented in Section 30.8.4.

Note that loading the object means loading the object from a database into memory, or marking it for active use if it is already in the memory hierarchy. Object loading is the portion that tool implementors need to look at for efficiency considerations. Reading the data of an object, if loaded in memory, is a simple consequence of the load initialization (`vpi_load_init()`) and/or `vpi_load()` optionally called by the user. The API does not specify here any memory hierarchy or caching strategy that governs the access (load or read) speed. It is left up to tool implementation to choose the appropriate scheme. It is recommended that this happens in a fashion invisible to the user without requiring additional routine calls.

The API here provides the tool with the chance to prepare itself for data load and access with the `vpi_load_init()`. With this call, the tool can examine what objects the user wishes to access before the actual read access is made. The API also provides the user the ability to force loads and unloads but it is recommended to leave this to the tool unless there is a need for the user application to influence this aspect.

#### 30.8.3.1 Iterating the design for the loaded objects

The user shall be allowed to optionally iterate for the loaded objects in a specific instantiation scope using `vpi_iterate()`. This shall be accomplished by calling `vpi_iterate()` with the appropriate reference handle, and using the property `vpiDataLoaded`. This is shown below.

- a) Iterate all data read loaded objects in the design: use a NULL reference handle (`ref_h`) to `vpi_iterate()`, e.g.,

```
itr = vpi_iterate(vpiDataLoaded, /* ref_h */ NULL);
while (loadedObj = vpi_scan(itr)) {
 /* process loadedObj */
}
```

- b) Iterate all data read loaded objects in an instance: pass the appropriate instance handle as a reference handle to `vpi_iterate()`, e.g.,

```
itr = vpi_iterate(vpiDataLoaded, /* ref_h */ instanceHandle);
while (loadedObj = vpi_scan(itr)) {
 /* process loadedObj */
}
```

#### 30.8.3.2 Iterating the object collection for its member objects

The user shall be allowed to iterate for the design objects in a design collection using `vpi_iterate()` and `vpi_scan()`. This shall be accomplished by creating an iterator for the members of the collection and then use `vpi_scan()` on the iterator handle e.g.

```
vpiHandle var_handle; /* some object */
vpiHandle varCollection; /* object collection */
vpiHandle Var; /* object handle */
vpiHandle itr; /* iterator handle */
/* Create object collection */
```

```

varCollection = vpi_create(vpiObjCollection, NULL, NULL);
/* Add elements to the object collection */
varCollection = vpi_create(vpiObjCollection, varCollection, var_handle);

/* Iterating a collection for its elements */
itr = vpi_iterate(vpiMember, varCollection); /* create iterator*/
while (Var = vpi_scan(itr)) { /* scan iterator */
/* process Var */
}

```

### 30.8.4 Reading an object

The sections above have outlined:

- How to select an object for access, in other words, marking this object as a target for access. This is where the design navigation VPI is used.
- How to call `vpi_load_init()` as a hint on the areas to be accessed, and/or optionally load an object into memory after obtaining a handle and then either loading objects individually or as a group using the object collection.
- How to optionally iterate the design scope and the object collection to find the loaded objects if needed.

In this section reading data is discussed. Reading an object's data means obtaining its value changes. VPI, before this extension, had allowed a user to query a value at a specific point in time—namely the current time, and its access does not require the extra step of giving a load hint or actually loading the object data. This step is added here because VPI is extended with a temporal access component: The user can ask about all the values in time (regardless of whether that value is available to a particular tool, or found in memory or a database, the mechanism is provided) since accessing this value horizon involves a larger memory expense, and possibly a considerable access time. Let's see now how to access and traverse this value timeline of an object.

To access the value changes of an object over time, a traverse object is used, as introduced earlier in Section 30.4.1. Several VPI routines are also added to traverse the value changes (using this new handle) back and forth. This mechanism is very different from the “iteration” notion of VPI that returns objects related to a given object, the traversal here can walk or jump back and forth on the value change timeline of an object. To create a value change traverse handle the routine `vpi_handle()` must be called in the following manner:

```
vpiHandle trvsHndl = vpi_handle(vpiTrvsObj, object_handle);
```

Note that the user (or tool) application can create more than one value change traverse handle for the same object, thus providing different views of the value changes. Each value change traverse handle shall have a means to have an internal index, which is used to point to its “current” time and value change of the place it points. In fact, the value change traversal can be done by increasing or decreasing this internal index. What this index is, and how its function is performed is left up to tools' implementation; It is only used as a concept for explanation here.

Once created the traverse handle can point anywhere along the timeline; its initial location is left for tool implementation. However, if the traverse object has no value changes the handle shall point to the minimum time (of the trace), so that calls to `vpi_get_time()` can return a valid time. It is up to the user to call an initial `vpi_goto()` to move to the desired initial pointing location.

#### 30.8.4.1 Traversing value changes of objects

After getting a traverse `vpiHandle`, the application can do a forward or backward walk or jump traversal by using `vpi_goto()` on a `vpiTrvsObj` object type with the new traverse properties.

Here is a sample code segment for the complete process from handle creation to traversal.

```

p_vpi_extension reader_p; /* Pointer to VPI reader extension structure */
vpiHandle instanceHandle; /* Some scope object is inside */

```



```

vpiHandle var_handle; /* Object handle */
vpiHandle vc_trvs_hdl; /* Traverse handle */
vpiHandle itr;
p_vpi_value value_p; /* Value storage */
p_vpi_time time_p; /* Time storage */
PLI_INT32 code; /* return code */
...
/* Initialize the read interface: Access data from memory */
/* NOTE: Use built-in VPI (e.g. that of simulator application is running
 under) */
reader_p = vpi_load_extension(NULL, NULL, vpiAccessLimitedInteractive);

if (reader_p == NULL) ... ; /* Not successful */

/* Initialize the load: Access data from simulator) memory, for scope
instanceHandle and its subsopes */
/* NOTE: Call marks access for all the objects in the scope */
vpi_load_init(NULL, instanceHandle, 0);

itr = vpi_iterate(vpiVariables, instanceHandle);
while (var_handle = vpi_scan(itr)) {
/* Demo how to force the load, this part can be skipped in general */
 if (vpi_get(vpiIsLoaded, var_handle) == 0) { /* not loaded*/
 /* Load data: object-based load, one by one */
 if (!vpi_load(var_handle)); /* Data not found ! */
 break;
 }
}
/*-- End of Demo how to force the load, this part can be skipped in general */
/* Create a traverse handle for read queries */
vc_trvs_hdl = vpi_handle(vpiTrvsObj, var_handle);
/* Go to minimum time */
vc_trvs_hdl = vpi_goto(vpiMinTime, vc_trvs_hdl, NULL, NULL);
/* Get info at the min time */
time_p->type = vpiSimTime;
vpi_get_time(vc_trvs_hdl, time_p); /* Minimum time */
vpi_printf(...);
vpi_get_value(vc_trvs_hdl, value_p); /* Value */
vpi_printf(...);
if (vpi_get(vpiHasDataVC, vc_trvs_hdl)) { /* Have any VCs ? */
 for (;;) { /* All the elements in time */
 vc_trvs_hdl = vpi_goto(vpiNextVC, vc_trvs_hdl, NULL, &code);
 if (!code) {
 /* failure (e.g. already at MaxTime or no more VCs) */
 break; /* cannot go further */
 }
 /* Get Max time: Set bits of s_vpi_time type field */
 /* time_p->type = vpiMaxTime & vpiSimTime; */
 /* vpi_get_time(vc_trvs_hdl, time_p); */
 time_p->type = vpiSimTime;
 vpi_get_time(vc_trvs_hdl, time_p); /* Time of VC */
 vpi_get_value(vc_trvs_hdl, value_p); /* VC data */
 }
}
}
/* free handles */
vpi_free_object(...);

```

The code segment above declares an interactive access scheme, where only a limited history of values is pro-

vided by the tool (e.g. simulator). It then creates a Value Change (VC) traverse handle associated with an object whose handle is represented by `var_handle` but only after `vpi_load_init()` is called. It then creates a traverse handle, `vc_trvs_hdl`. With this traverse handle, it first calls `vpi_goto()` to move to the minimum time where the value has changed. It moves the handle (internal index) to that time by calling `vpi_goto()` with a `vpiMinTime` argument. It then repeatedly calls `vpi_goto()` with a `vpiNextVC` to move the internal index forward repeatedly until there is no value change left. `vpi_get_time()` gets the actual time where this VC is, and data is obtained by `vpi_get_value()`. The application can also choose to call `vpi_goto()` with a `time_p` argument to automatically get the VC time instead of calling `vpi_get_time()` separately to get this information.

The traverse and collection handles can be freed when they are no longer needed using `vpi_free_object()`.

### 30.8.4.2 Jump Behavior

Jump behavior refers to the behavior of `vpi_goto()` with a `vpiTime` control constant, `vpiTrvsObj` type, and a jump time argument. The user specifies a time to which he or she would like the traverse handle to jump, but the specified time might or might not have value changes. In that case, the traverse handle shall point to the latest VC equal to or less than the time requested.

In the example below, the whole simulation run is from time 10 to time 65, and a variable has value changes at time 10, 15 and 50. If a value change traverse handle is associated with this variable and a jump to a different time is attempted, the result shall be determined as follows:

- Jump to 12; traverse handle return time is 10.
- Jump to 15; traverse handle return time is 15.
- Jump to 65; traverse handle return time is 50.
- Jump to 30; traverse handle return time is 15.
- Jump to 0; traverse handle return time is 10.
- Jump to 50; traverse handle return time is 50.

If the jump time has a value change, then the internal index of the traverse handle shall point to that time. Therefore, the return time is exactly the same as the jump time.

If the jump time does not have a value change, and if the jump time is not less than the minimum time of the whole trace<sup>2</sup> run, then the return time is aligned backward. If the jump time is less than the minimum time, then the return time shall be the minimum time. In case the object has *hold value semantics* between the VCs such as static variables, then the return of `vpi_goto()` (with a specified time argument to jump to) is a new handle pointing to that time to indicate *success*. In case the time is greater than the trace maximum time, or when an automatic object or an assertion or any other object that does not hold its value between the VCs then the return code should indicate *failure* (and the backward time alignment is still performed). In other words the time returned by the traverse object shall never exceed the trace maximum; the maximum point in the trace is not marked as a VC unless there is truly a value change at that point in time (see the example in this sub-section).

### 30.8.4.3 Dump off regions

When accessing a database, it is likely that there are gaps along the value time-line where possibly the data recording (e.g. dumping from simulator) was turned off. In this case the starting point of that interval shall be marked as a VC if the object had a stored value before that time. `vpi_goto()`, whether used to jump to that time or using next VC or previous VC traversal from a point before or after respectively, shall stop at that VC. Calling `vpi_get_value()` on the traverse object pointing to that VC shall have no effect on the value argument passed; the time argument shall be filled with the time at that VC. `vpi_get()` can be called in the form: `vpi_get(vpiHasNoValue, <traverse handle>)` to return TRUE if the traverse handle has no value (i.e.

<sup>2</sup> The word trace can be replaced by “simulation”; trace is used here for generality since a dump file can be generated by several tools.

pointing to the start of a dump off region) and FALSE otherwise.

There is, of course, another VC (from no recorded value to an actual recorded value) at the end of the dump off interval, if the end exists i.e. there is additional dumping performed and data for this object exists before the end of the trace. There are no VCs in between the two marking the beginning and end (if they exist); a move to the next VC from the start point leads to the end point.

### 30.8.5 Sample code using object (and traverse) collections

```

p_vpi_extension reader; /* Pointer to reader VPI library */
vpiHandle scope; /* Some scope being looked at */
vpiHandle var_handle; /* Object handle */
vpiHandle some_net; /* Handle of some net */
vpiHandle some_reg; /* Handle of some reg */
vpiHandle vc_trvs_hdl1; /* Traverse handle */
vpiHandle vc_trvs_hdl2; /* Traverse handle */
vpiHandle itr; /* Iterator */
vpiHandle objCollection; /* Object collection */
vpiHandle trvsCollection; /* Traverse collection */

PLI_BYTE8 *data = "my_database"; /* database */
p_vpi_time time_p; /* time */
PLI_INT32 code; /* Return code */

/* Initialize the read interface: Post process mode, read from a database */
/* NOTE: Uses "toolX" library */
reader_p = vpi_load_extension("toolX", data, vpiAccessPostProcess);

if (reader_p == NULL) ... ; /* Not successful */

/* Get the scope using its name */
scope = reader_p->vpi_handle_by_name("top.m1.s1", NULL);
/* Create object collection */
objCollection = reader_p->vpi_create(vpiObjCollection, NULL, NULL);

/* Add data to collection: All the nets in scope */
/* ASSUMPTION: (waveform) tool "toolX" supports this navigation
relationship */
itr = reader_p->vpi_iterate(vpiNet, scope);
while (var_handle = reader_p->vpi_scan(itr)) {
 objCollection = reader_p->vpi_create(vpiObjCollection, objCollection,
 var_handle);
}
/* Add data to collection: All the regs in scope */
/* ASSUMPTION: (waveform) tool supports this navigation relationship */
itr = reader_p->vpi_iterate(vpiReg, scope);
while (var_handle = reader_p->vpi_scan(itr)) {
 objCollection = reader_p->vpi_create(vpiObjCollection, objCollection,
 var_handle);
}

/* Initialize the load: focus only on the signals in the object collection:
objCollection */
reader_p->vpi_load_init(objCollection, NULL, 0);

/* Demo scanning the object collection */
itr = reader_p->vpi_iterate(vpiMember, objCollection);
while (var_handle = reader_p->vpi_scan(itr)) {
 ...

```

```

}

/* Application code here */
some_net = ...;
time_p = ...;
some_reg = ...;
....
vc_trvs_hdl1 = reader_p->vpi_handle(vpiTrvsObj, some_net);
vc_trvs_hdl2 = reader_p->vpi_handle(vpiTrvsObj, some_reg);
vc_trvs_hdl1 = reader_p->vpi_goto(vpiTime, vc_trvs_hdl1, time_p, &code);
vc_trvs_hdl2 = reader_p->vpi_goto(vpiTime, vc_trvs_hdl2, time_p, &code);
/* Data querying and processing here */
....

/* free handles*/
reader_p->vpi_free_object(...);

/* close database */
reader_p->vpi_close(0, vpiAccessPostProcess, data);

```

The code segment above initializes the read interface for post process read access from database data. It then creates an object collection `objCollection` then adds to it all the objects in scope of type `vpiNet` and `vpiReg` (assuming this type of navigation is allowed in the tool). Load access is initialized and set to the objects listed in `objCollection`. `objCollection` can be iterated using `vpi_iterate()` to create the iterator and then using `vpi_scan()` to scan it assuming here that the waveform tool provides this navigation. The application code is then free to obtain traverse handles for the objects, and perform its querying and data processing as it desires.

The code segment below shows a simple code segment that mimics the function of a `$dumpvars` call to access data of all the regs in a specific scope and its subscopes and process the data.

```

p_vpi_extension reader_p; /* Reader library pointer */
vpiHandle big_scope; /* Some scope being looked at */
vpiHandle obj_handle; /* Object handle */
vpiHandle obj_trvs_hdl; /* Traverse handle */
vpiHandle signal_iterator; /* Iterator for signals */
p_vpi_time time_p; /* time */

/* Initialize the read interface: Access data from simulator */
/* NOTE: Use built-in VPI (e.g. that of simulator application is running */
/* under */
reader_p = vpi_load_extension(NULL, NULL, vpiAccessLimitedInteractive);

if (reader_p == NULL) ... ; /* Not successful */

/* Initialize the load access: data from (simulator) memory, for scope */
/* big_scope and its subscopes */
/* NOTE: Call marks load access */
vpi_load_init(NULL, big_scope, 0);

/* Application code here */
/* Obtain handle for all the regs in scope */
signal_iterator = vpi_iterate(vpiReg, big_scope);

/* Data querying and processing here */
while ((obj_handle = vpi_scan(signal_iterator)) != NULL) {
 assert(vpi_get(vpiType, obj_handle) == vpiReg);
 /* Create a traverse handle for read queries */

```

```

 obj_trvs_hdl = vpi_handle(vpiTrvsObj, obj_handle);
 time_p = ...; /* some time */
 obj_trvs_hdl = vpi_goto(vpiTime, obj_trvs_hdl, time_p, &code);
 /* Get info at time */
 vpi_get_value(obj_trvs_hdl, value_p); /* Value */
 vpi_printf("....");
}
/* free handles*/
vpi_free_object(...);

```

### 30.8.6 Object-based traversal

Object based traversal can be performed by creating a traverse handle for the object and then moving it back and forth to the next or previous Value Change (VC) or by performing jumps in time. A traverse object handle for any object in the design can be obtained by calling `vpi_handle()` with a `vpiTrvsObj` type, and an object `vpiHandle`. This is the method described in Section 30.8.4, and used in all the code examples thus far.

Using this method, the traversal would be object-based because the individual object traverse handles are created, and then the application can query the (value, time) pairs for each VC. This method works well when the design is being navigated and there is a need to access the (stored) data of any individual object.

### 30.8.7 Time-ordered traversal

Alternatively, a user might wish to do a time-ordered traversal i.e. a time-based examination of values of several objects. This can be done by using a collection. The first step is to create a *traverse collection* of type `vpiTrvsCollection` of the objects to be traversed from the design object collection of type `vpiObjCollection` using `vpi_handle()` with a `vpiTrvsCollection` type and collection handle argument. `vpi_goto()` can then be called on the traverse collection to move to next or previous or do jump in time for the collection as a whole. A move to next (previous) VC means move to the next (previous) earliest VC among the objects in the collection; any traverse handle that does not have any VC is ignored; on return its new handle points to the same place as its old. A jump to a specific time aligns the new returned handles of all the objects in the collection (as if this had been done object by object, but here it is done in one-shot for all elements).

It is possible to loop in time by incrementing the time, and doing a jump to those time increments. This is shown in the following code snippet.

```

vpiHandle objCollection = ...;
vpiHandle trvsCollection;
p_vpi_time time_p;
PLI_INT32 code;

/* Obtain (create) traverse collection from object collection */
trvsCollection = vpi_handle(vpiTrvsCollection, objCollection);
/* Loop in time: increments of 100 units */
for (i = 0; i < 1000; i = i + 100) {
 time_p = ...;
 /* Go to point in time */
 trvsCollection = vpi_goto(vpiTime, trvsCollection, time_p, &code);
 ...
}

```

Alternatively, the user might wish to get a new collection returned of all the objects that have a value change at the given time the traverse collection was moved to. In this case `vpi_filter()` follows the call to `vpi_goto()`. The latter returns a new collection with all the new traverse objects, whether they have a VC or not. `vpi_filter()` allows us to filter the members that have a VC at that time. This is shown in the code snippet that follows.

```
...
```

```

vpiHandle retrrvsCollection; /* Collection for all the objects */
vpiHandle vctrvsCollection; /* collection for the objects with VC */
vpiHandle itr; /* collection member iterator */
...
/* Go to earliest next VC in the collection */
for (;;) { /* for all collection VCs in time */
 retrrvsCollection = vpi_goto(vpiNextVC, trvsCollection, NULL, &code);
 if (!code) {
 /* failure (e.g. already at MaxTime or no more VCs) */
 break; /* cannot go further */
 }
 vctrvsCollection = vpi_filter(retrrvsCollection, vpiHasVC, 1);
 /* create iterator then scan the VC collection */
 itr = vpi_iterate(vpiMember, vctrvsCollection);
 while (vc_trvs1_hdl = vpi_scan(itr)) {
 /* Element has a VC */
 vpi_get_value(vc_trvs1_hdl, value_p); /* VC data */
 /* Do something at this VC point */
 ...
 }
 ...
}

```

### 30.9 Optionally unloading the data

The implementation tool should handle unloading the unused data in a fashion invisible to the user. Managing the data caching and memory hierarchy is left to tool implementation but it should be noted that failure to unload can affect the tool performance and capacity.

The user can optionally choose to call `vpi_unload()` to unload the data from (active) memory if the user application is done with accessing the data.

Calling `vpi_unload()` before releasing (freeing) traverse (collection) handles that are manipulating the data using `vpi_free_object()` is not recommended practice by users; the behavior of traversal using existing handles is not defined here. It is left up to tool implementation to decide how best to handle this. Tools shall, however, prevent creation of new traverse handles, after the call to `vpi_unload()`, by returning the appropriate fail codes in the respective creation routines.

### 30.10 Reading data from multiple databases and/or different read library providers

The VPI routine `vpi_load_extension()` is used to load VPI extensions. Such extensions include reader libraries from such tools as waveform viewers. `vpi_load_extension()` shall return a pointer to a function pointer structure with the following definition.

```

typedef struct {
 void *user_data; /* Attach user data here if needed */
 /* Below this point user application MUST NOT modify any values */
 size_t struct_size; /* Must be set to sizeof(s_vpi_extension) */
 long struct_version; /* Set to 1 for SystemVerilog 3.1a */
 PLI_BYTE8 *extension_version;
 PLI_BYTE8 *extension_name;
 /* One function pointer for each of the defined VPI routines:
 - Each function pointer has to have the correct prototype */
 ...
 PLI_INT32 (*vpi_chk_error)(error_info_p);
 ...
 PLI_INT32 (*vpi_vprintf)(PLI_BYTE8 *format, ...);
}

```

```

 ...
} s_vpi_extension, *p_vpi_extension;

```

Subsequent versions of the `s_vpi_extension` structure shall only extend it by adding members at the end; previously existing entries must not be changed, removed, or re-ordered in order to preserve backward compatibility. The `struct_size` entry allows users to perform basic sanity checks (e.g. before type casting), and the `struct_version` permits keeping track and checking the version of the `s_vpi_extension` structure. The structure also has a `user_data` field to give users a way to attach data to a particular load of an extension if they wish to do so.

The structure shall have an entry for *every* VPI routine; the order and synopsis of these entries within the structure shall exactly match the order and synopsis of function definitions in Chapter 27 of the Verilog Standard, IEEE Std 1364-2001. After those entries the SystemVerilog VPI routine additions for assertions `vpi_get_assertion_info()` and then `vpi_register_assertion_cb()` shall be added in that order. Then all new reader routines defined in Table 30-3 shall be added in exactly the order noted in the table. If a particular extension does not support a specific VPI routine, then it shall still have an entry (with the correct prototype), and a dummy body that shall always have a return (consistent with the VPI prototype) to signify failure (i.e. `NULL` or `FALSE`). The routine call must also raise the appropriate VPI error, which can be checked by `vpi_chk_error()`, and/or automatically generate an error message in a manner consistent with the specific VPI routine.

If tool providers want to add their own implementation extensions, those extensions must only have the effect of making the `s_vpi_extension` structure *larger* and any non-standard content must occur after all the standard fields. This permits applications to use the pointer to the extended structure as if it was a `p_vpi_extension` pointer, yet still allow the applications to go beyond and access or call tool-specific fields or routines in the extended structure. For example, a tool extended `s_vpi_extension` could be:

```

typedef struct {
 /* inline a copy of s_vpi_extension */
 /* begin */
 void *user_data;
 ...
 /* end */
 /* "toolZ" extension with one additional routine */
 int (*toolZfunc)(int);
} s_toolZ_extension, *p_toolZ_extension;

```

An example of use of the above extended structure is as follows:

```

p_vpi_extension h;
p_toolZ_extension hZ;

h = vpi_load_extension("toolZ", <args>);
if (h && (h->struct_size >= sizeof(s_toolZ_extension))
 && !(strcmp(h->extension_version, "...")
 && !strcmp(h->extension_name, "toolZ"))) {
 hZ = (p_toolZ_extension) h;
 /* Can now use hZ to access all the VPI routines, including toolZ's
 'toolZfunc' */
 ...
}

```

The SystemVerilog tool the user application is running under is responsible for loading the appropriate extension, i.e. the reader API library in the case of the read API. The extension name is used for this purpose, following a specific policy, for example, this extension name can be the name of the library to be loaded. Once the reader API library is loaded all VPI function calls that wish to use the implementation in the library shall be performed using the returned `p_vpi_extension` pointer as an indirection to call the function pointers specified in `s_vpi_extension` or the extended vendor specific structure as described above. Note that, as stated earlier, in the case the application is using the built-in routine implementation (i.e. the ones provided by the

tool (e.g. simulator) it is running under) then the de-reference through the pointer is not necessary.

Multiple databases can be opened for read simultaneously by the application. After a `vpi_load_extension()` call, a top scope handle can be created for that database to be used later to derive any other handles for objects in that database. An example of multiple database access is shown below. In the example, `scope1` and `scope2` are the top scope handles used to point into `database1` and `database2` respectively and perform the processing (comparing data in the two databases for example).

```

p_vpi_extension reader_pX; /* Pointer to reader libraryfunction struct */
p_vpi_extension reader_pY; /* Pointer to reader libraryfunction struct */
vpiHandle scope1, scope2; /* Some scope being looked at */
vpiHandle var_handle; /* Object handle */
vpiHandle some_net; /* Handle of some net */
vpiHandle some_reg; /* Handle of some reg */
vpiHandle vc_trvs_hdl1; /* Traverse handle */
vpiHandle vc_trvs_hdl2; /* Traverse handle */
vpiHandle itr; /* Iterator */
vpiHandle objCollection1, objCollection2; /* Object collection */
vpiHandle trvsCollection1, trvsCollection2; /* Traverse collection */
p_vpi_time time_p; /* time */

PLI_BYTE8 *data1 = "database1";
PLI_BYTE8 *data2 = "database2";

/* Initialize the read interface: Post process mode, read from a database */
/* NOTE: Use library from "toolX" */
reader_pX = vpi_load_extension("toolX", data1, vpiAccessPostProcess);
/* Get the scope using its name */
/* NOTE: scope handle comes from database: data1 */
scope1 = reader_pX->vpi_handle_by_name("top.m1.s1", NULL);

/* Initialize the read interface: Post process mode, read from a database */
/* NOTE: Use library from "toolY" */
reader_pY = vpi_load_extension("toolY", data2, vpiAccessPostProcess);
/* Get the scope using its name */
/* NOTE: scope handle comes from database: data2 */
scope2 = reader_pY->vpi_handle_by_name("top.m1.s1", NULL);

/* Create object collections */
objCollection1 = reader_pX->vpi_create(vpiObjCollection, NULL, NULL);
objCollection2 = reader_pY->vpi_create(vpiObjCollection, NULL, NULL);

/* Add data to collection1: All the nets in scope1,
 data comes from database1 */
/* ASSUMPTION: (waveform) tool supports this navigation relationship */
itr = reader_pX->vpi_iterate(vpiNet, scope1);
while (var_handle = reader_pX->vpi_scan(itr)) {
 objCollection1 = reader_pX->vpi_create(vpiObjCollection, objCollection1,
 var_handle);
}

/* Add data to collection2: All the nets in scope2,
 data comes from database2 */
/* ASSUMPTION: (waveform) tool supports this navigation relationship */
itr = reader_pY->vpi_iterate(vpiNet, scope2);
while (var_handle = reader_pY->vpi_scan(itr)) {
 objCollection2 = reader_pY->vpi_create(vpiObjCollection, objCollection2,
 var_handle);
}

```



```

}

/* Initialize the load: focus only on the signals in the object collection:
objCollection */
reader_pX->vpi_load_init(objCollection1, NULL, 0);
reader_pY->vpi_load_init(objCollection2, NULL, 0);

/* Demo: Scan the object collection */
itr = reader_pX->vpi_iterate(vpiMember, objCollection1);
while (var_handle = reader_pX->vpi_scan(itr)) {
 ...
}
itr = reader_pY->vpi_iterate(vpiMember, objCollection2);
while (var_handle = reader_pY->vpi_scan(itr)) {
 ...
}

/* Application code here: Access Objects from database1 or database2 */
some_net = ...;
time_p = ...;
some_reg = ...;
....
/* Data querying and processing here */
....

/* free handles*/
reader_pX->vpi_free_object(...);
reader_pY->vpi_free_object(...);

/* close databases */
reader_pX->vpi_close(0, vpiAccessPostProcess, data1);
reader_pY->vpi_close(0, vpiAccessPostProcess, data2);

```

### 30.11 VPI routines extended in SystemVerilog

Table 30-1 lists the usage extensions. They are repeated here the *additional extended usage* with traverse (collection) handles of `vpi_get_time()` for clarity.

`vpi_get_time()`

**Synopsis:** Retrieve the time of the object or collection of objects traverse handle.

**Syntax:** `vpi_get_time(vpiHandle obj, p_vpi_time time_p)`

**Returns:** `PLI_INT32`, 1 for success, 0 for fail.

**Arguments:**

`vpiHandle obj`: Handle to a traverse object of type `vpiTrvsObj` or a traverse collection of type `vpiTrvsCollection`.

`p_vpi_time time_p`: Pointer to a structure containing the returned time information. There are several cases to consider:

```

PLI_INT32 type = ...; /* vpiScaledRealTime, vpiSimTime, or vpiSuppresTime */
(time_p == type): Get the time of traverse object or collection. In case of collection
return time only if all the members have the same time, otherwise time_p is not modified.
(time_p == vpiMinTime & type): Gets the minimum time of traverse object or
collection.
(time_p == vpiMaxTime & type): Gets the maximum time of traverse object or
collection.

```

(time\_p == vpiNextVC & type): Gets the time where traverse handle points next. Returns failure if traverse object or collection has no next VC and time\_p is not modified. In the case of a collection, it returns success when any traverse object in the collection has a next VC, time\_p is updated with the smallest next VC time.

(time\_p == vpiPrevVC & type): Gets the time where traverse handle previously points. Returns failure if traverse object or collection has no previous VC and time\_p is not modified. In the case of a collection, it returns success when any traverse object in the collection has a previous VC, time\_p is updated with the largest previous VC time.

**Related routines:** None.

## 30.12 VPI routines added in SystemVerilog

This section describes the additional VPI routines in detail.

vpi\_load\_extension()

**Synopsis:** Load specified VPI extension. The general form of this function allows for later extensions. For the reader-specific form, initialize the reader with access mode, and specify the database if used.

**Syntax:** vpi\_load\_extension(PLI\_BYTE8 \*extension\_name, ...) in its general form

```
vpi_load_extension(PLI_BYTE8 *extension_name,
 PLI_BYTE8 *name,
 vpiType mode, ...) for the reader extension
```

**Returns:** PLI\_INT32, 1 for success, 0 for fail.

**Arguments:**

PLI\_BYTE8 \*extension\_name: Extension name of the extension library to be loaded.

In the case of the reader, this is the reader VPI library (with the supported navigation VPI routines).

...: Contains all the additional arguments. For the reader extension these are:

PLI\_BYTE8 \*name: Database.

vpiType mode:

vpiAccessLimitedInteractive: Access data in tool memory, with limited history. The tool shall at least have the current time value, no history is required.

vpiAccessInteractive: Access data interactively. Tool shall keep value history up to the current time.

vpiAccessPostProcess: Access data stored in specified database.

...: Additional arguments if required by specific reader extensions.

**Related routines:** None.

### 30.12.1 VPI reader routines

vpi\_close()

**Synopsis:** Close the database if open.

**Syntax:** vpi\_close(PLI\_INT32 tool, vpiType prop, PLI\_BYTE8\* name)

**Returns:** PLI\_INT32, 1 for success, 0 for fail.

**Arguments:**

PLI\_INT32 tool: 0 for the reader.

vpiType prop:

vpiAccessPostProcess: Access data stored in specified database.

vpiAccessInteractive: Access data interactively, database is the flush area. Tool shall keep value history up to the current time.

PLI\_BYTE8\* name: Name of the database. This can be the logical name of a database or the actual name of the data file depending on the tool implementation.

**Related routines:** None.

vpi\_load\_init()

**Synopsis:** Initialize the load access to scope and/or collection of objects.

**Syntax:** `vpi_load_init(vpiHandle objCollection, vpiHandle scope, PLI_INT32 level)`

**Returns:** PLI\_INT32, 1 for success, 0 for fail.

**Arguments:**

`vpiHandle objCollection`: Object collection of type `vpiObjCollection`, a collection of design objects.

`vpiHandle scope`: Scope of the load.

`PLI_INT32 level`: If 0 then enables read access to scope and all its subscopes, 1 means just the scope.

**Related routines:** None.

`vpi_load()`

**Synopsis:** Load the data of the given object into memory for data access and traversal if object is an object handle; load the whole collection (i.e. set of objects) if passed handle is an object collection of type `vpiObjCollection`.

**Syntax:** `vpi_load(vpiHandle h)`

**Returns:** PLI\_INT32, 1 for success of loading (all) object(s) (in collection), 0 for fail of loading (any) object (in collection).

**Arguments:**

`vpiHandle h`: Handle to a design object (of any valid type) or object collection of type `vpiObjCollection`.

**Related routines:** None

`vpi_unload()`

**Synopsis:** Unload the given object data from (active) memory if object is an object handle, unload the whole collection if passed object is a collection of type `vpiObjCollection`. See Section 30.9 for a description of data unloading.

**Syntax:** `vpi_unload(vpiHandle h)`

**Returns:** PLI\_INT32, 1 for success, 0 for fail.

**Arguments:**

`vpiHandle h`: Handle to an object or collection (of type `vpiObjCollection`).

**Related routines:** None.

`vpi_create()`

**Synopsis:** Create or add to an object or traverse collection.

**Syntax:** `vpi_create(vpiType prop, vpiHandle h, vpiHandle obj)`

**Returns:** `vpiHandle` of type `vpiObjCollection` for success, NULL for fail.

**Arguments:**

`vpiType prop`:

`vpiObjCollection`: Create (or add to) object (`vpiObjCollection`) or traverse (`vpiTrvsCollection`) collection.

`vpiHandle h`: Handle to a (object) traverse collection of type (`vpiObjCollection`)

`vpiTrvsCollection`, NULL for first call (creation)

`vpiHandle obj`: Handle of object to add, NULL if for first time creation of collection.

**Related routines:** None.

`vpi_goto()`

**Synopsis:** Try to move to min, max or specified time. A new traverse (collection) handle is returned pointing to the specified time. If the traverse handle (members of collection) has a VC at that time then the returned handle (members of returned collection) is updated to point to the specified time, otherwise it is not updated. If the passed handle has no VC (for collection this means no VC for any object) a fail is indicated, otherwise a success is indicated. In case of a jump to a specified time, and there is no value change at the specified time, then the value change traverse index of the returned (new) handle (member of returned collection) is aligned based on the jump behavior defined in Section 30.8.4.2, and its time (and the time pointer argument if passed and is non-NULL) shall be updated based on the aligned traverse

point. In the case of `vpiNextVC` or `vpiPrevVC`, the time argument, if passed and is non-NULL (otherwise it is ignored and not updated), is updated if there is a VC (for collection this means a VC for any object) to the new time, otherwise the value is not updated.

**Syntax:** `vpi_goto(vpiType prop, vpiHandle obj, p_vpi_time time_p, PLI_INT32 *ret_code)`

**Returns:** `vpiHandle` of type `vpiTrvsObj` (`vpiObjCollection`).

**Arguments:**

`vpiType prop:`

`vpiMinTime:` Goto the minimum time of traverse collection handle.

`vpiMaxTime:` Goto the maximum time of traverse collection handle.

`vpiTime:` Jump to the time specified in `time_p`.

`vpiNextVC:` Goto the (time of) next VC.

`vpiPrevVC:` Goto the (time of) previous VC.

`vpiHandle obj:` Handle to a traverse object (collection) of type `vpiTrvsObj` (`vpiTrvsCollection`)

`p_vpi_time time_p:` Pointer to a structure containing time information. Used only if `prop` is of type `vpiTime`, otherwise it is ignored.

`PLI_INT32 *ret_code:` Pointer to a return code indicator. It is 1 for success and 0 for fail.

**Related routines:** None.

`vpi_filter()`

**Synopsis:** Filter a general collection, a traversable object collection, or traverse collection according to a specific criterion. Return a collection of the handles that meet the criterion. Original collection is not changed.

**Syntax:** `vpi_filter(vpiHandle h, PLI_INT32 ft, PLI_INT32 flag)`

**Returns:** `vpiHandle` of type `vpiObjCollection` for success, NULL for fail.

**Arguments:**

`vpiHandle h:` Handle to a collection of type `vpiCollection`, `vpiObjCollection` or `vpiTrvsCollection`

`PLI_INT32 ft:` Filter criterion, any `vpiType` or a VPI boolean property.

`PLI_INT32 flag:` Flag to indicate whether to match criterion (if set to TRUE), or not (if set to FALSE).

**Related routines:** None.

## Section 31 SystemVerilog VPI Object Model

LRM 183

### 31.1 Introduction (informative)

SystemVerilog extends the Verilog Procedural Interface (VPI) object diagrams to support SystemVerilog constructs. The VPI object diagrams document the properties of objects and the relationships of objects. How these diagrams illustrate this information is explained in Section 26 of the IEEE Std. 1364-2001 Verilog standard. The SystemVerilog extensions to the VPI diagrams are in the form of changes to or additions to the diagrams contained in 1364-2001 Verilog standard. The following table summarizes these changes and additions.

The following table summarizes the changes and additions made to the Verilog VPI object diagrams:

**Table 31-4: Verilog VPI object diagram changes and additions**

| Diagram                    | Notes                                   |
|----------------------------|-----------------------------------------|
| Instances                  | New                                     |
| Interface                  | New                                     |
| Program                    | New                                     |
| Module                     | Replaces IEEE 1364.2001 section 26.6.1  |
| Modport                    | New                                     |
| Interface tf decl          | New                                     |
| Ports                      | Replaces IEEE 1364.2001, section 26.6.5 |
| Ref Obj                    | New                                     |
| Variable                   | Replaces IEEE 1364.2001 section 26.6.8  |
| Var select                 | New                                     |
| Typespec                   | New                                     |
| Variable Drivers and Loads | New                                     |
| Instance Arrays            | Replaces IEEE 1364.2001 section 26.6.2  |
| Scope                      | Replaces IEEE 1364.2001 section 26.6.3  |
| IO Declaration             | Replaces IEEE 1364.2001 section 26.6.4  |
| Class Object Definition    | New                                     |
| Constraint                 | New                                     |
| Dist Item                  | New                                     |
| Constraint Expression      | New                                     |
| Class Variables            | New                                     |
| Structure/Union            | New                                     |
| Named Events               | New                                     |
| Named Event Array          | New                                     |

**Table 31-4: Verilog VPI object diagram changes and additions (continued)**

| Diagram                        | Notes                                           |
|--------------------------------|-------------------------------------------------|
| Task, Function Declaration     | Replaces IEEE 1364.2001 section 26.6.18         |
| Alias Statement                | New                                             |
| Frames                         | Replaces IEEE 1364.2001 section 26.6.20         |
| Threads                        | New                                             |
| Concurrent Assertions          | New                                             |
| Disable Condition              | New                                             |
| Clocking Event                 | New                                             |
| Property Declaration           | New                                             |
| Property Specification         | New                                             |
| Property Expression            | New                                             |
| Multiclock Sequence Expression | New                                             |
| Sequence Declaration           | New                                             |
| Sequence Expression            | New                                             |
| Instances                      | New                                             |
| Atomic Statement               | New                                             |
| if, if-else                    | Replaces IEEE 1364-2001 section 26.6.35         |
| case                           | Replaces IEEE 1364-2001 section 26.6.36         |
| return                         | New                                             |
| do while                       | New                                             |
| waits                          | Replaces wait in IEEE 1364-2001 section 26.6.32 |
| disables                       | Replaces IEEE 1364-2001 section 26.6.38         |
| expect                         | New                                             |
| foreach                        | New                                             |

### 31.2 Instances

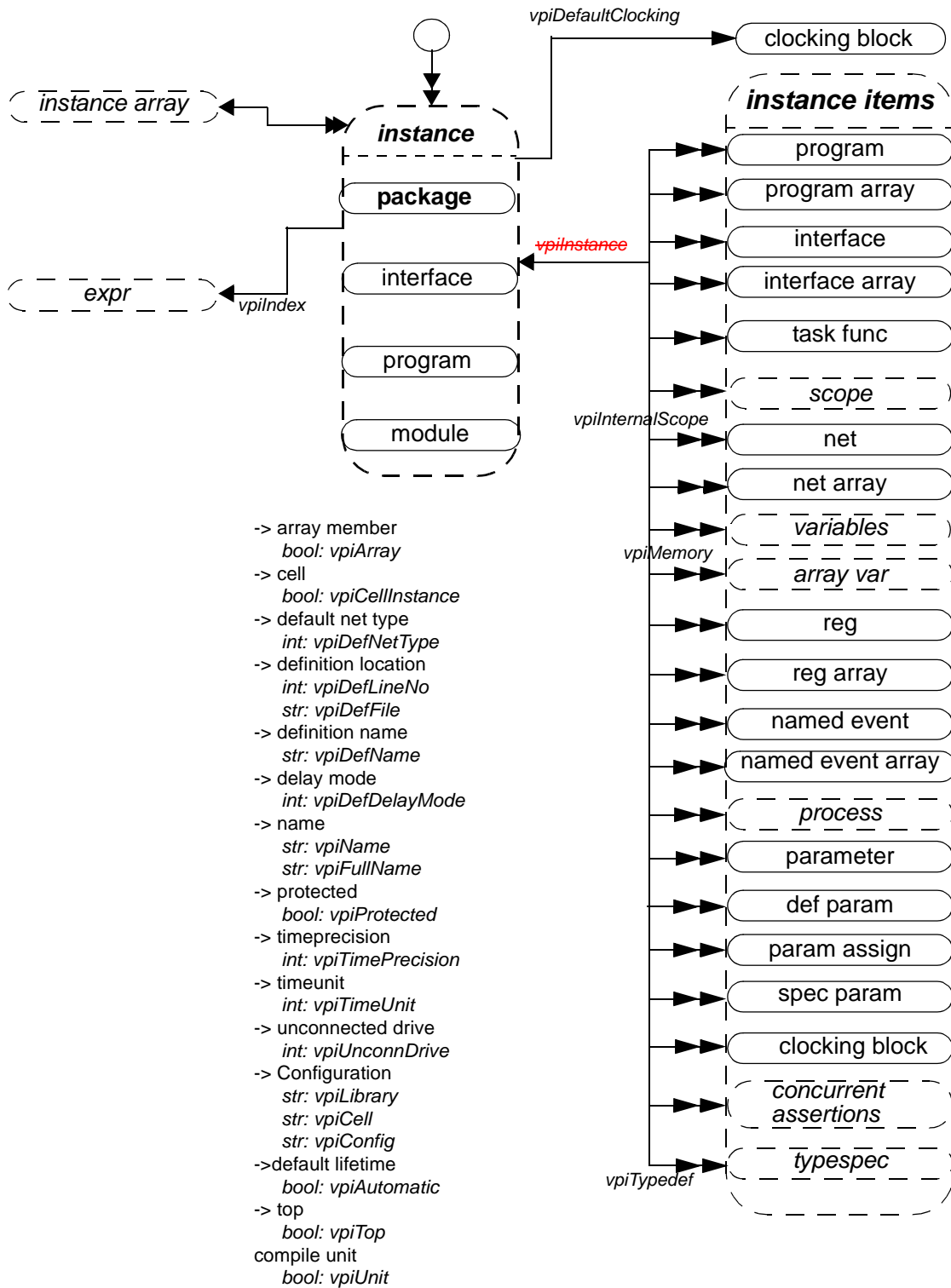

## NOTES

- 1) Top-level instances shall be accessed using **vpi\_iterate()** with a NULL reference object.
- 1) Passing a NULL handle to **vpi\_get()** with types **vpiTimePrecision** or **vpiTimeUnit** shall return the smallest time precision of all instances in the design.
- 2) If an instance is an element within an array, the **vpiIndex** transition is used to access the index within the array. If the instance is not part of an array, this transition shall return NULL.
- 3) Compilation units are represented as packages that have a **vpiUnit** property set to TRUE. Such implicitly declared packages shall have implementation dependent names.

## 31.3 Interfaces

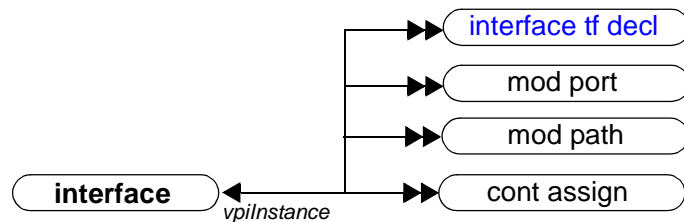

## NOTE

All interfaces are instances and all relations and properties in the Instances diagram also apply.

## 31.4 Program

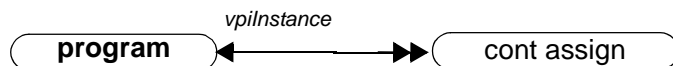

## NOTE

All programs are instances and all relations and properties in the Instances diagram also apply.



### 31.5 Module (supersedes IEEE 1364-2001 26.6.1)

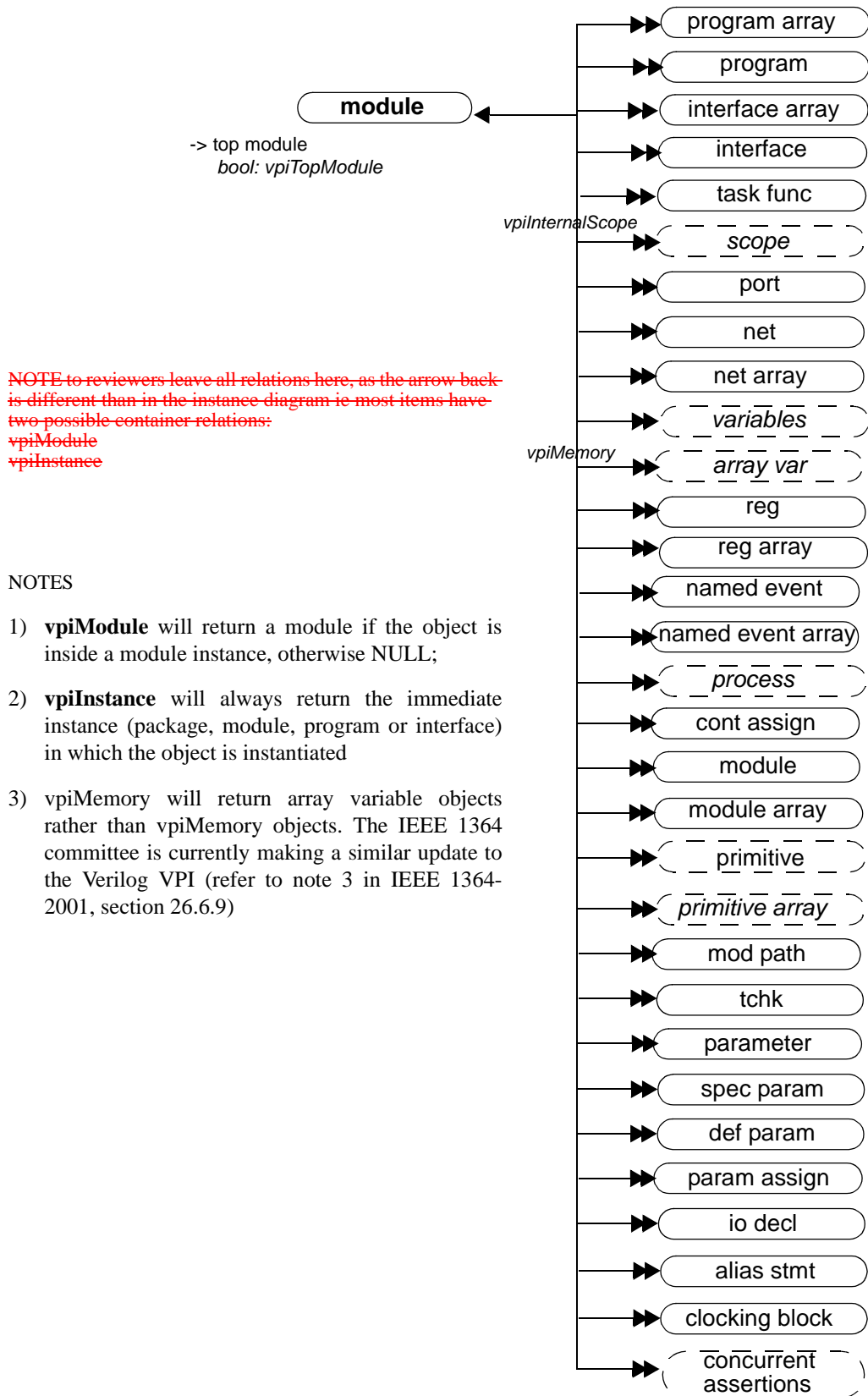

NOTES

- 1) **vpiModule** will return a module if the object is inside a module instance, otherwise NULL;
- 2) **vpiInstance** will always return the immediate instance (package, module, program or interface) in which the object is instantiated
- 3) vpiMemory will return array variable objects rather than vpiMemory objects. The IEEE 1364 committee is currently making a similar update to the Verilog VPI (refer to note 3 in IEEE 1364-2001, section 26.6.9)

### 31.6 Modport

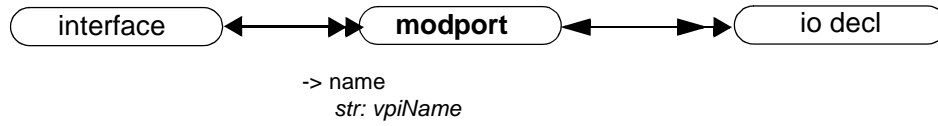

### 31.7 Interface tf decl

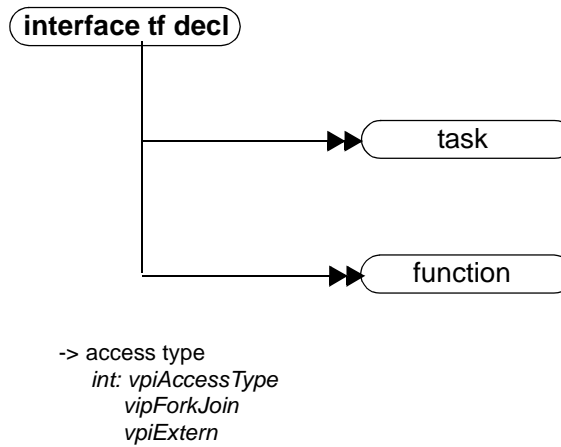

NOTE

**vpiIterate(vpiTaskFunc)** can return more than one task/function declaration for modport tasks/functions with an access type of **vpiForkJoin**, because the task or function can be imported from multiple module instances.

### 31.8 Ports (supersedes IEEE 1364-2001 26.6.5)

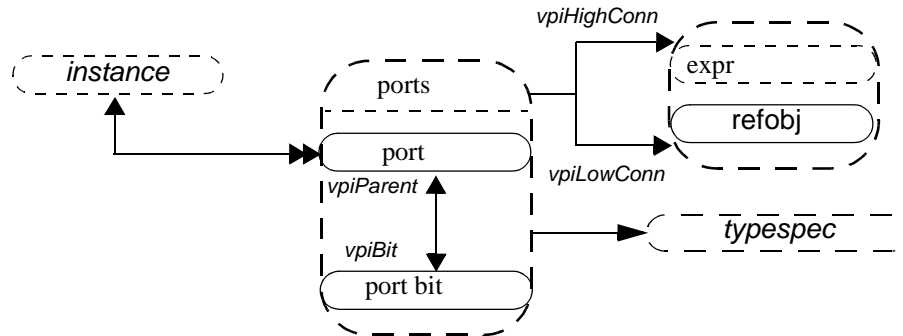

- > connected by name  
*bool: vpiConnByName*
- > delay (mipd)  
*vpi\_get\_delays()*  
*vpi\_put\_delays()*
- > direction  
*int: vpiDirection*
- > explicitly named  
*bool: vpiExplicitName*
- > index  
*int: vpiPortIndex*
- > name  
*str: vpiName*
- > port type  
*int: vpiPortType*
- > scalar  
*bool: vpiScalar*
- > size  
*int: vpiSize*
- > vector  
*bool: vpiVector*

#### NOTES

- 1) **vpiPortType** shall be one of the following three types: **vpiPort**, **vpiInterfacePort**, and **vpiModportPort**. Port type depends on the formal, not on the actual.
- 2) **vpi\_get\_delays**, **vpi\_put\_delays** delays shall not be applicable for **vpiInterfacePort**.
- 1) **vpiHighConn** shall indicate the hierarchically higher (closer to the top module) port connection.
- 2) **vpiLowConn** shall indicate the lower (further from the top module) port connection.
- 3) **vpiLowConn** of a **vpiInterfacePort** shall always be **vpiRefObj**.
- 4) Properties scalar and vector shall indicate if the port is 1 bit or more than 1 bit. They shall not indicate anything about what is connected to the port.
- 5) Properties index and name shall not apply for port bits.
- 6) If a port is explicitly named, then the explicit name shall be returned. If not, and a name exists, then that name shall be returned. Otherwise, NULL shall be returned.
- 7) **vpiPortIndex** can be used to determine the port order. The first port has a port index of zero.
- 8) **vpiHighConn** and **vpiLowConn** shall return NULL if the port is not connected.
- 9) **vpiSize** for a null port shall return 0.

### 31.9 Ref Obj

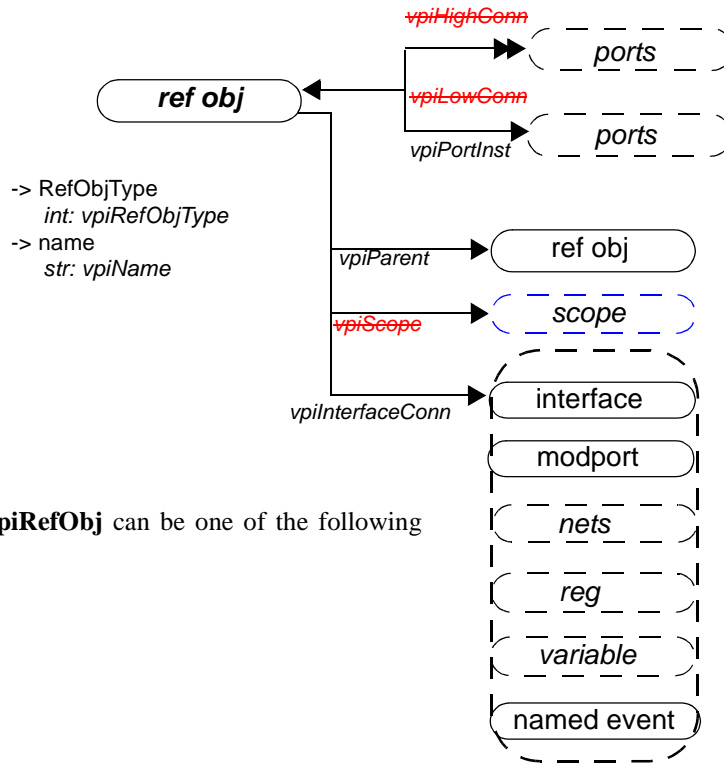

NOTES

- 1) **vpiRefObjType** of **vpiRefObj** can be one of the following types:
  - vpiInterface
  - vpiModport
  - vpiNet
  - vpiReg
- 10) **vpiPort** and **vpiPortInst** is defined only for **vpiRefObj** where **vpiRefObjType** is **vpiInterface**.

#### 31.9.1 Examples

These objects are newly defined objects needed for supporting the full connectivity through ports where the ports are vpiInterface or vpiModport or any object inside modport or interface.

RefObjs are dummy objects and they always have a handle to the original object.

```
interface simple ()

logic req, gnt;
modport slave (input req, output gnt);
modport master (input gnt, output req);
}
module top()

interface simple i;

child1 i1(i);
child2 i2(i.master);
endmodule
/*****
for port of i1,
 vpiHighConn = vpiRefObj where vpiRefObjType = vpiInterface
```

```

for port of i2 ,
 vpiHighConn = vpiRefObj where vpiFullType = vpiModport
 *****/
module child1(interface simple s)
 c1 c_1(s);
 c1 c_2(s.master);
endmodule
/*****/
for port of child1,
 vpiLowConn = vpiRefObj where vpiRefObjType = vpiInterface
for that refObj,
 vpiPort is = port of child1.
vpiPortInst is = s, s.master
vpiInterfaceConn is = i.
for port of c_1 :
 vpiHighConn is a vpiRefObj, where full type is vpiInterface.
for port of c_2 :
 vpiHighConn is a vpiRefObj, where full type is vpiModport.

```

### 31.10 Variables (supersedes IEEE 1364-2001 section 26.6.8)

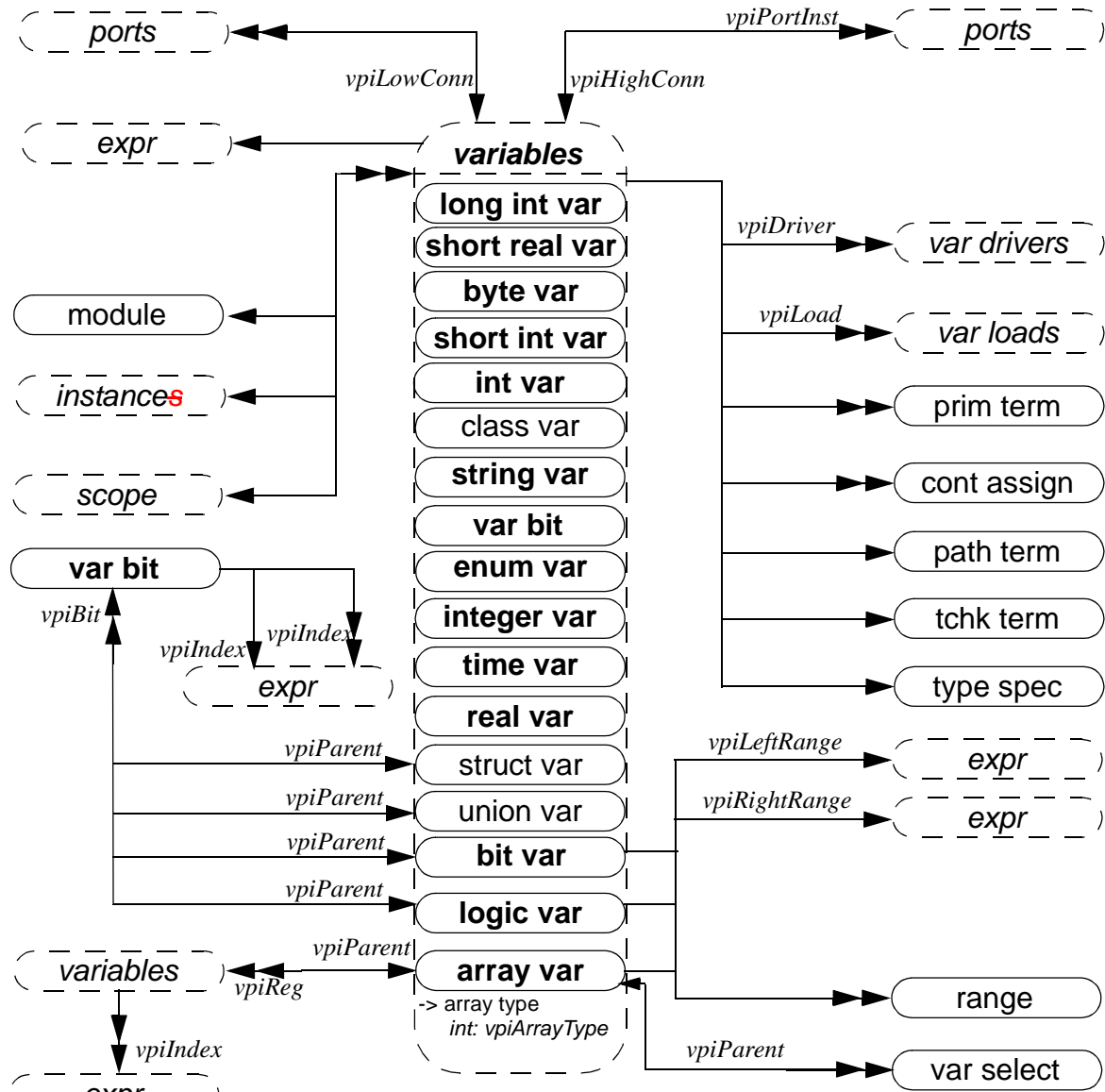

- > array member  
bool: vpiArray
- > name  
str: vpiName  
str: vpiFullName
- > sign  
bool: vpiSigned
- > size  
int: vpiSize
- > determine random availability  
bool: vpiIsRandomized

- > multi-array  
bool: vpiMultiArray
- > array type  
int: vpiArrayType  
can be one of vpiStaticArray, vpiDynamicArray, vpiAssocArray, vpiQueue
- > lifetime  
bool: vpiAutomatic (ref. 26.6.20, 1364 2001)
- > constant variable  
bool: vpiConstantVariable
- > randomization type  
int: vpiRandType  
can be vpiRand, vpiRandC, vpiNotRand

- > member  
bool: vpiMember
- > value  
vpi\_get\_value()  
vpi\_put\_value()
- > packed array  
bool: vpiPackedArray
- > scalar  
bool: vpiScalar
- > visibility  
int: vpiVisibility
- > vector  
bool: vpiVector

NOTES

- 1) A var select is a word selected from a variable array.

- 2) The boolean property **vpiArray** shall be TRUE if the variable handle references an array of variables, and FALSE otherwise. If the variable is an array, iterate on **vpiVarSelect** to obtain handles to each variable in the array.
- 3) To obtain the members of a union and structure, see the relations in section **30.21**
- 4) The range relation is valid only when **vpiArray** is true. When applied to array vars this relation returns only unpacked ranges. When applied to logic and bit variables, it returns only the packed ranges.
- 5) **vpi\_handle** (**vpiIndex**, **var\_select\_handle**) shall return the index of a var select in a 1-dimensional array. **vpi\_iterate** (**vpiIndex**, **var\_select\_handle**) shall return the set of indices for a var select in a multidimensional array, starting with the index for the var select and working outward
- 6) **vpiLeftRange** and **vpiRightRange** shall only apply if **vpiMultiArray** is not true, i.e. if the array is not multi-dimensional.
- 7) A variable handle of type **vpiArrayVar** represents an unpacked array. The range iterator for array vars returns only the unpacked ranges for the array.
- 8) If the variable has an initialization expression, the expression can be obtained from **vpi\_handle(vpiExpr, var\_handle)**
- 9) **vpiSize** for a variable array shall return the number of variables in the array. For non-array variables, it shall return the size of the variable in bits. For unpacked structures and unions the size returned indicates the number of fields in the structure or union.
- 10) **vpiSize** for a var select shall return the number of bits in the var select. This applies only for packed var select.
- 11) Variables whose boolean property **vpiArray** is TRUE do not have a value property.
- 12) **vpiBit** iterator applies only for logic, bit, packed struct, and packed union variables.
- 13) **vpi\_handle(vpiIndex, var\_bit\_handle)** shall return the bit index for the variable bit. **vpi\_iterate(vpiIndex, var\_bit\_handle)** shall return the set of indices for a multidimensional variable bit select, starting with the index for the bit and working outwards
- 14) **cbSizeChange** will be applicable only for dynamic and associative arrays. If both value and size change, the size change callback will be invoked first. This callback fires after size change occurs and before any value changes for that variable. The value in the callback is new size of the array.
- 15) The property *vpiRandType*, returns the current randomization type for the variable, which can be one of **vpiRand**, **vpiRandC**, and **vpiNotRand**.
- 16) **vpiIsRandomized** is a property to determine whether a random variable is currently active for randomization.
- 17) When the **vpiMember** property is true, it indicates that the variable is a member of a parent struct or union variable. See also relations in section **30.21**
- 18) If a variable is an element of an array, the **vpiIndex** iterator will return the indexing expressions that select that specific variable out of the array.
- 19) Note that:
  - logic var == reg
  - var bit var == reg bit
  - array var == reg array
20. The properties **vpiScalar** and **vpiVector** are applicable only to packed struct vars, packed union vars, bit vars and logic vars. These properties return false for all other objects.

**31.11 Var Select (supersedes IEEE 1364-2001 26.6.8)**

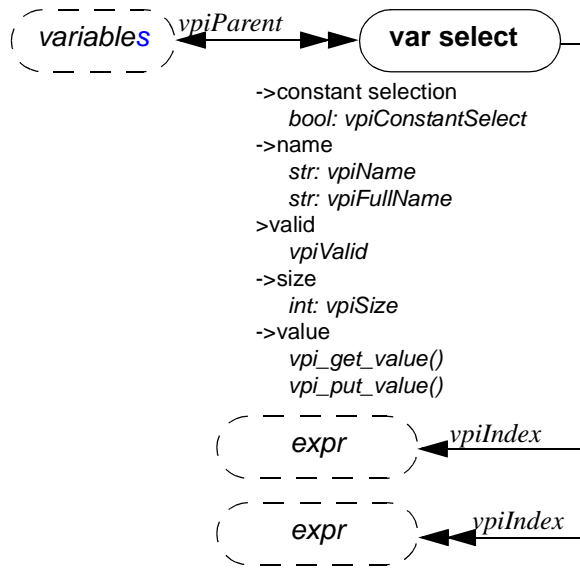



### 31.12 Typespec

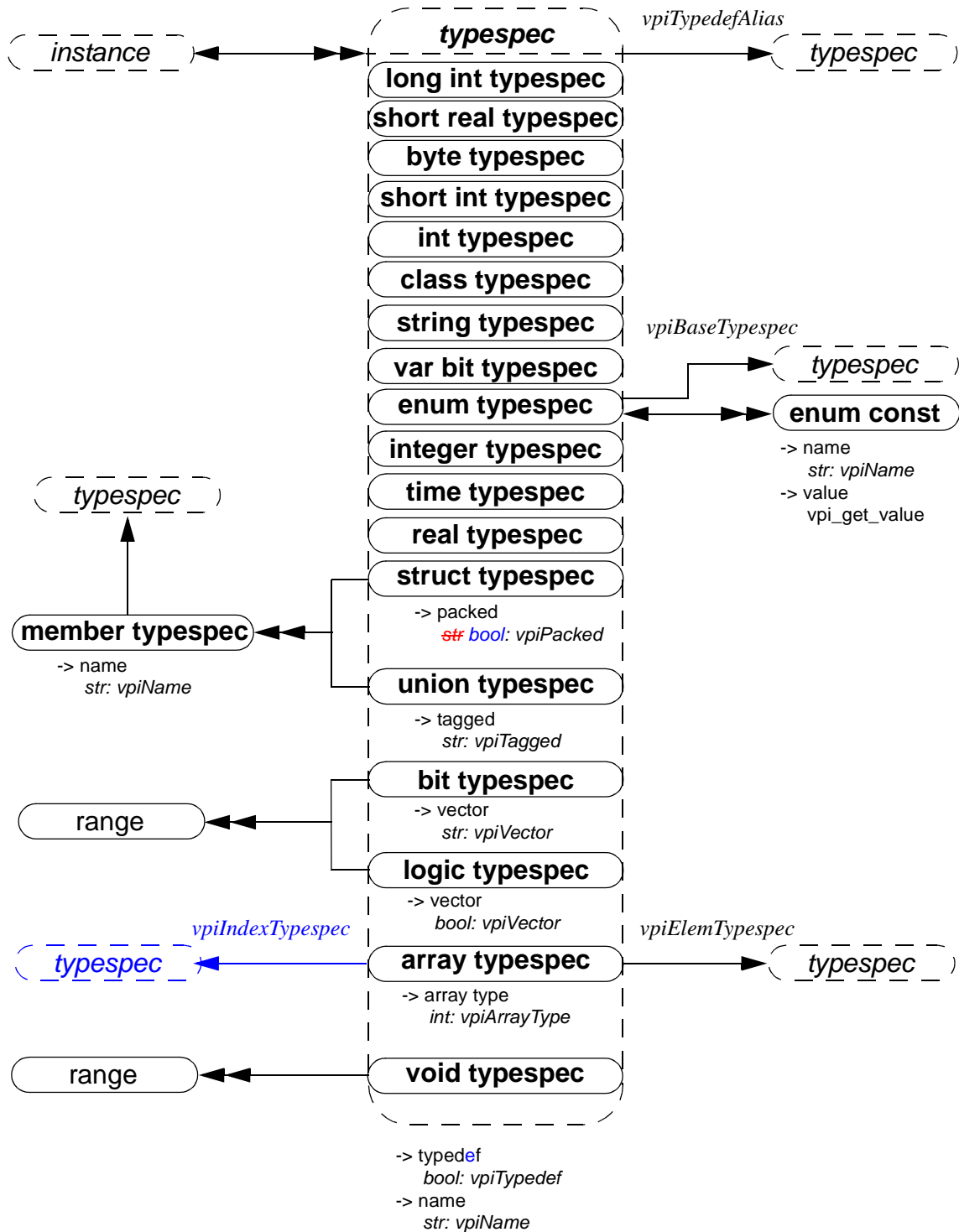

NOTES

- Typespec to typespec relation is used when the **vpiTypedefType** is "vpiTypedef", which will be the case for type aliases, for example, typedef a b;

2. **vpiIndexTypespec** relation is present only on associative arrays and returns the type that is used as the key into the associative array.
- 3) If the type of a type is **vpiStruct** or **vpiUnion**, then you can iterate over numbers to obtain the structure of the user-defined type. For each member the typespec relation from the member will detail its type.
- 4) The name of a typedef may be the empty string if the typedef is representing the type of a typedef field defined inline rather than via a typedef. For example:
- 5) typedef struct {  
    struct  
        int a;  
    }B  
} C;
- 6) The typedef C has **vpiTypedefType vpiStruct**, a single field named B with **vpiTypedefType vpiStruct**. Obtaining the typedef of field B, you will obtain a typedef with no name and a single field, named "a" with **vpiTypedefType** of **vpiInt**.

### 31.13 Variable Drivers and Loads (supersedes IEEE 1364-2001 26.6.23)

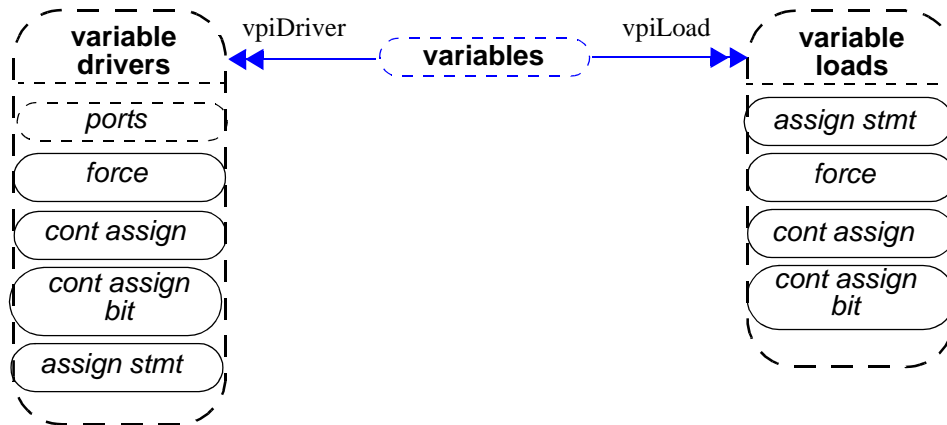

#### NOTES

- 1) **vpiDrivers/Loads** for a structure, union, or class variable will include the following:
  - Driver/Load for the whole variable
  - Driver/Load for any bit/part select of that variable
  - Driver/Load of any member nested inside that variable
- 2) **vpiDrivers/Loads** for any variable array should include the following:
  - Driver/Load for entire array/vector or any portion of an array/vector to which a handle can be obtained.

### 31.14 Instance Arrays (supersedes IEEE 1364-2001 26.6.2)

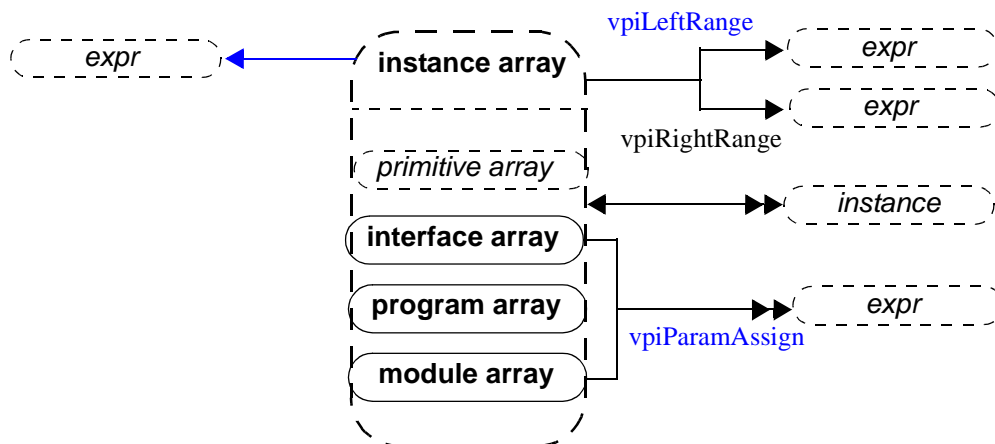

#### NOTE

Param assignments can only be obtained from non-primitive instance arrays.

### 31.15 Scope (supersedes IEEE 1364-2001 26.6.3)

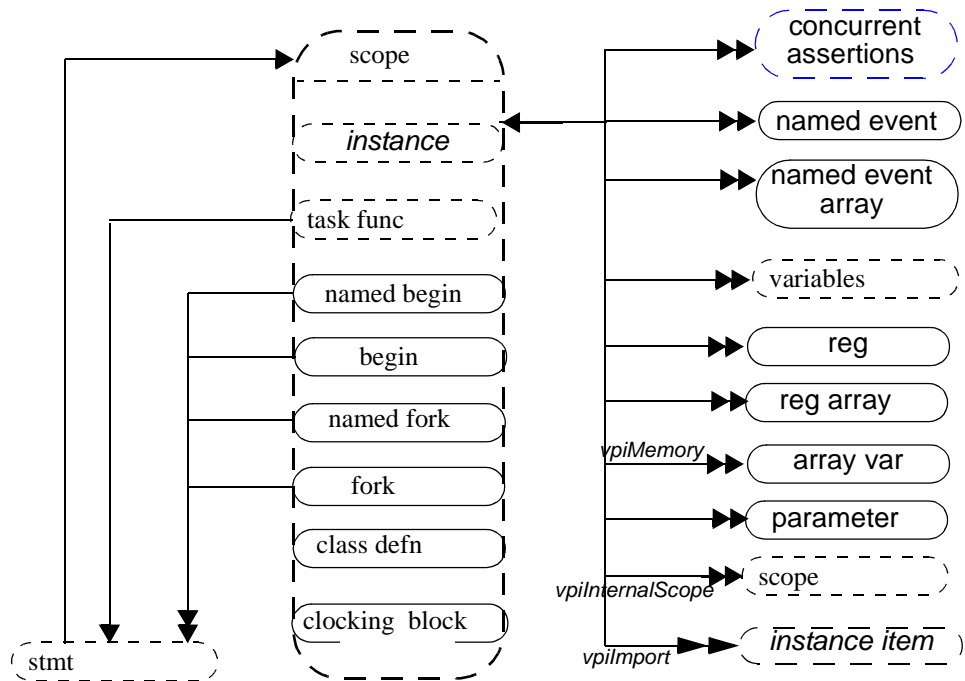

-> name  
str: *vpiName*  
str: *vpiFullName*

NOTE

- 1: Unnamed scopes shall have valid names, though tool dependent.
- 2: The *vpiImport* iterator shall return all objects imported into the current scope via import statements. Note that only objects actually referenced through the import shall be returned, rather than items potentially made visible as a result of the import. Refer to section 18.2.2 for more details.

### 31.16 IO Declaration (supersedes IEEE 1364-2001 26.6.4)

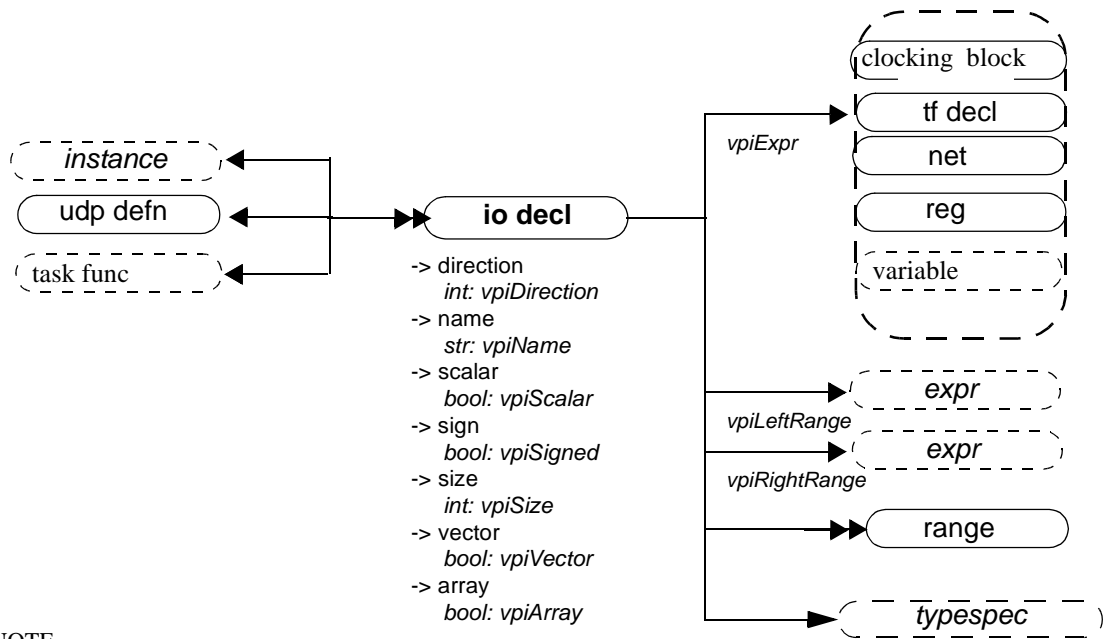

NOTE

**vpiDirection** returns **vpiRef** for pass by ref ports.

### 31.17 Clocking Block

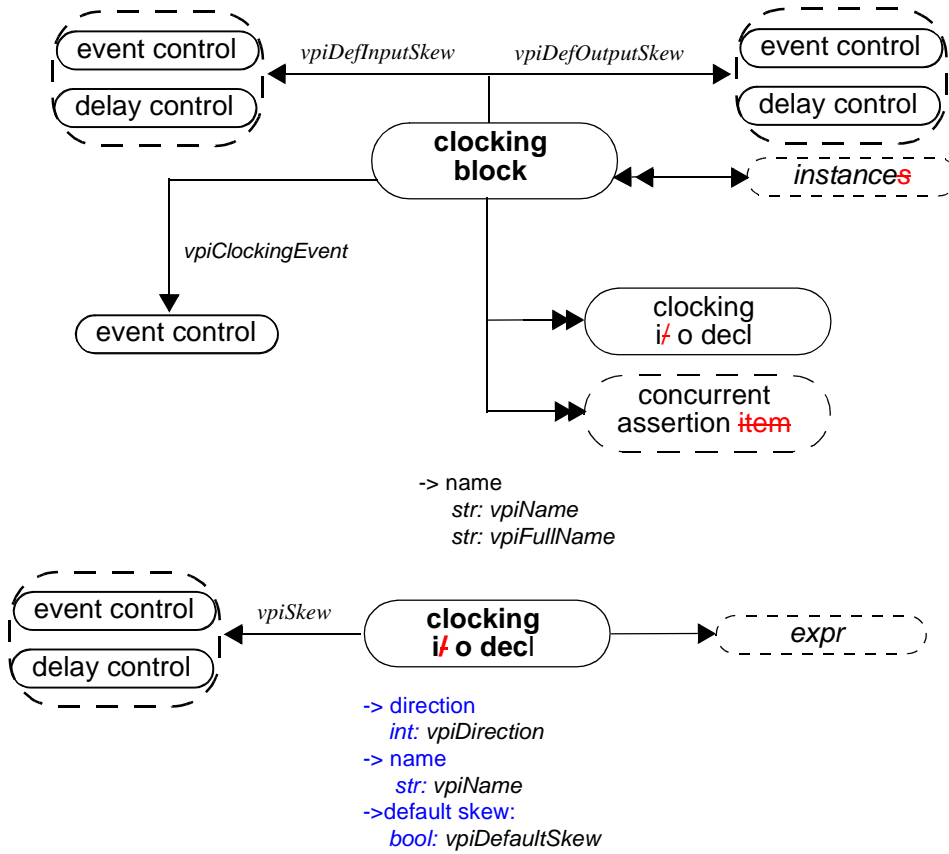

### 31.18 Class Object Definition

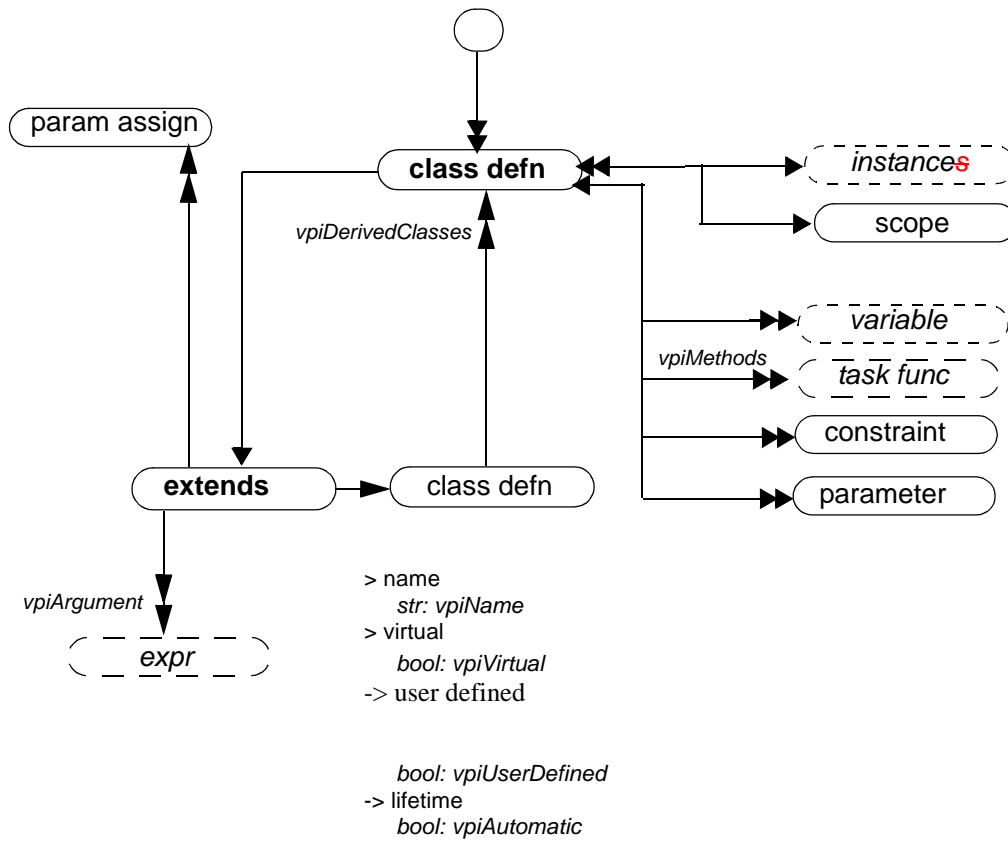

NOTE

- 1) **ClassDefn** handle is a new concept. It does not correspond to any **vpiUserDefined** (class object) in the design. Rather it represents the actual type definition of a class.
- 1) Should not call **vpi\_get\_value/vpi\_put\_value** on the non-static variables obtained from the class definition handle.
- 1) Iterator to constraints returns only normal constraints and not inline constraints.
- 1) To get constraints inherited from base classes, you will need to traverse the extend relation to obtain the base class.
- 1) The *vpiDerivedClasses* iterator returns all the classes derived from the given class.
- 1) The relation to **vpiExtend** exists whenever a one class is derived from another class (ref Section 11.12). The relation from extend to classDefn provides the base class. The iterators from extend to param assign and arguments provide the parameters and arguments used in constructor chaining (ref Section 11.16 and 11.23)

### 31.19 Constraint, constraint ordering, distribution,

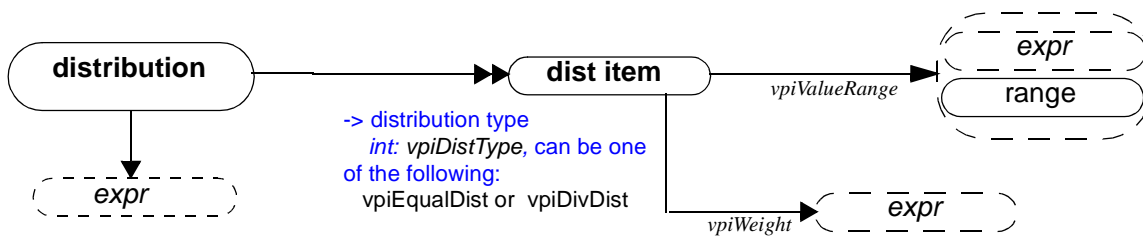
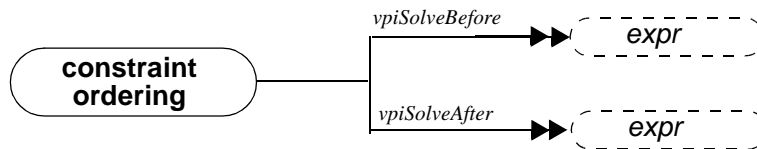
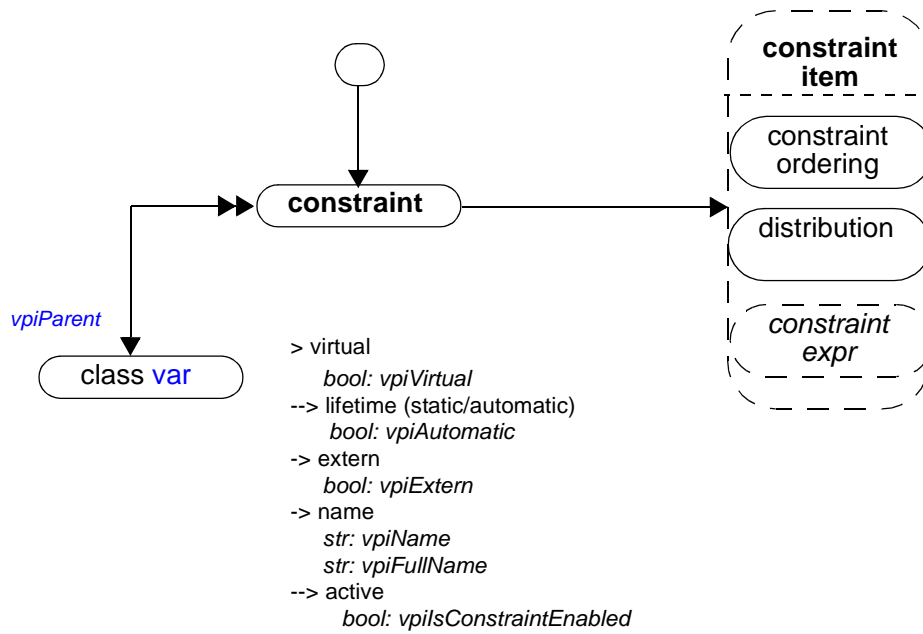



### 31.20 Constraint expression

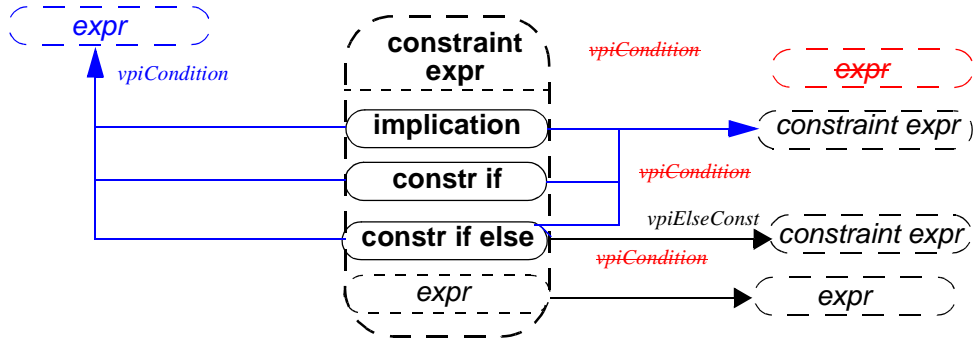

## 31.21 Class Variables

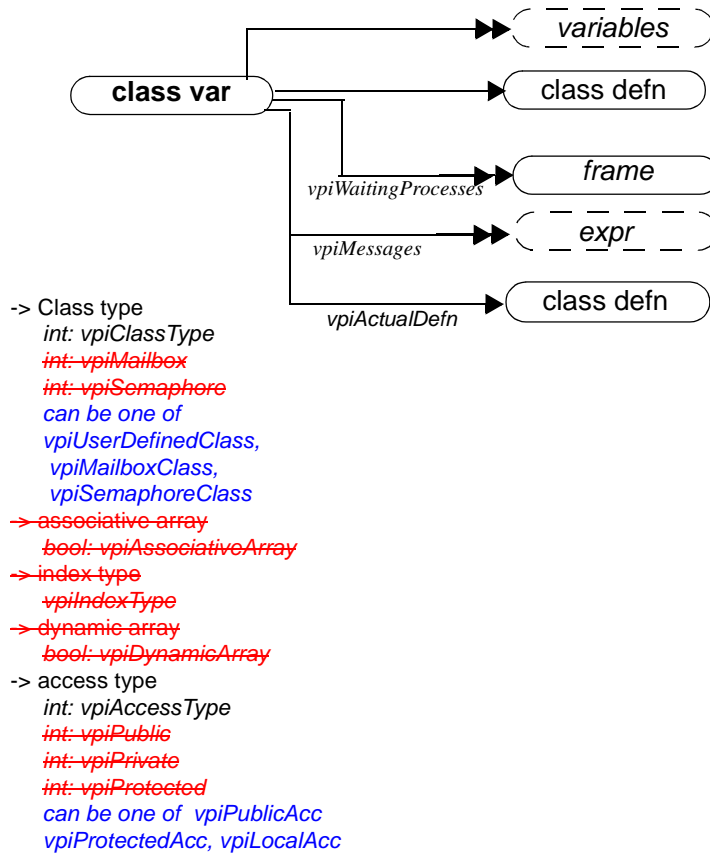

## NOTES

- 1) **vpiWaiting/Process** iterator on mailbox/semaphores will show the processes waiting on the object:  
 — Waiting process means either frame or task/function handle.
- 2) **vpiMessage** iterator shall return all the messages in a mailbox.
- 3) **vpiClassDefn** returns the ClassDefn which was used to create the handle. **vpiActualDefn** returns the ClassDefn that handle object points to when the query is made. The difference can be seen in the example below:  

```
class Packet
...
endclass : Packet

class LinkedPacket extends Packet
...
endclass : LinkedPacket

LinkedPacket l = new;
Packet p = l;
```

In this example, the **vpiClassDefn** of variable "p" is Packet, but the **vpiActualDefn** is "LinkedPacket".
- 4) **vpiClassDefn/vpiActualDefn** both shall return NULL for built-in classes.

### 31.22 Structure/Union

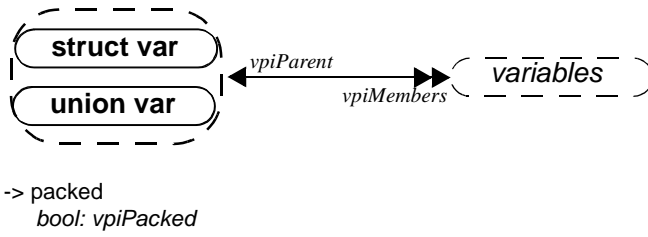

#### NOTES

**vpi\_get\_value/vpi\_put\_value** cannot be used to access values of entire unpacked structures and unpacked unions.

### 31.23 Named Events (supersedes IEEE 1364-2001 26.6.11)

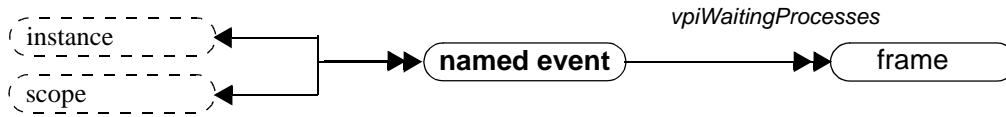

- > array member  
    *bool: vpiArray*
- > name  
    *str: vpiName*  
    *str: vpiFullName*
- > value  
    *vpi\_put\_value()*
- > *automatic*  
    *bool: vpiAutomatic*

NOTE

The new iterator (**vpiWaitingProcess**) returns all waiting processes, identified by their frame, for that namedEvent.

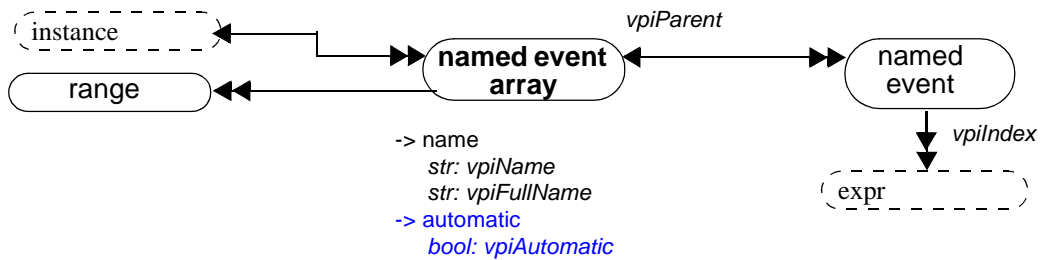

- > name  
    *str: vpiName*  
    *str: vpiFullName*
- > *automatic*  
    *bool: vpiAutomatic*

NOTE

**vpi\_iterate(vpiIndex, named\_event\_handle)** shall return the set of indices for a named event within an array, starting with the index for the named event and working outward. If the named event is not part of an array, a NULL shall be returned.

### 31.24 Task, Function Declaration (supersedes IEEE 1364-2001 26.6.18)

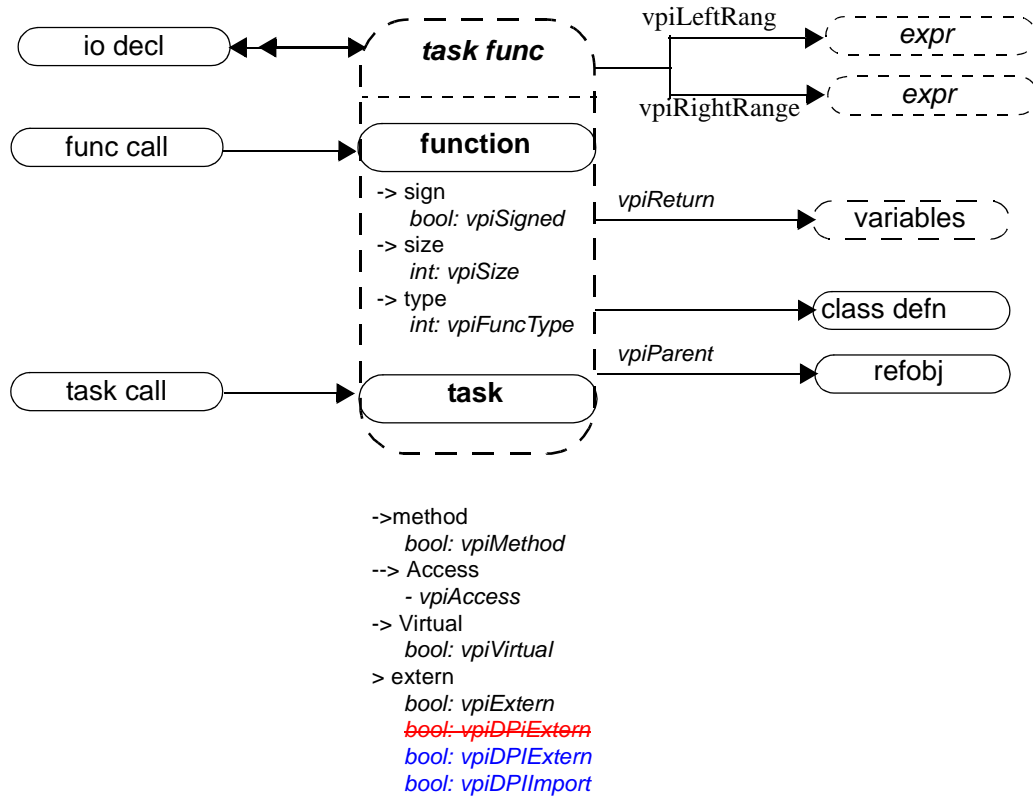

NOTE

- 5) A Verilog HDL function shall contain an object with the same name, size, and type as the function.
- 6) **vpiInterfaceTask/vpiInterfaceFunction** shall be true if task/function is declared inside an interface or a modport of an interface.
- 7) For function where return type is a user-defined type, **vpi\_handle** (vpiReturn,Function\_handle) shall return the implicit variable handle representing the return of the function from which the user can get the details of that user-defined type.
- 8) **vpiReturn** will always return a var object, even for simple returns.

## 31.25 Alias Statement

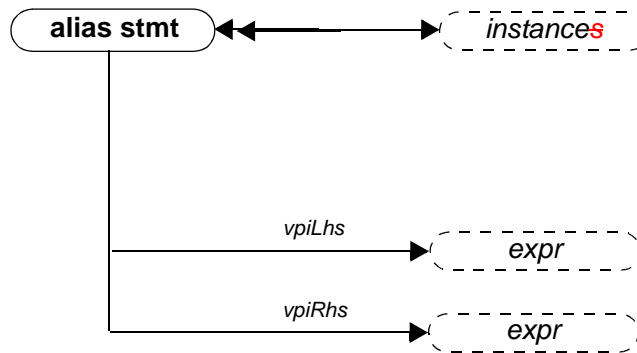

### 31.25.1 Examples

```
alias a=b=c=d
Results in 3 aliases:
```

```
alias a=d
alias b=d
alias c=d
d is Rhs for all.
```

### 31.26 Frames (supersedes IEEE 1364-2001 26.6.20)

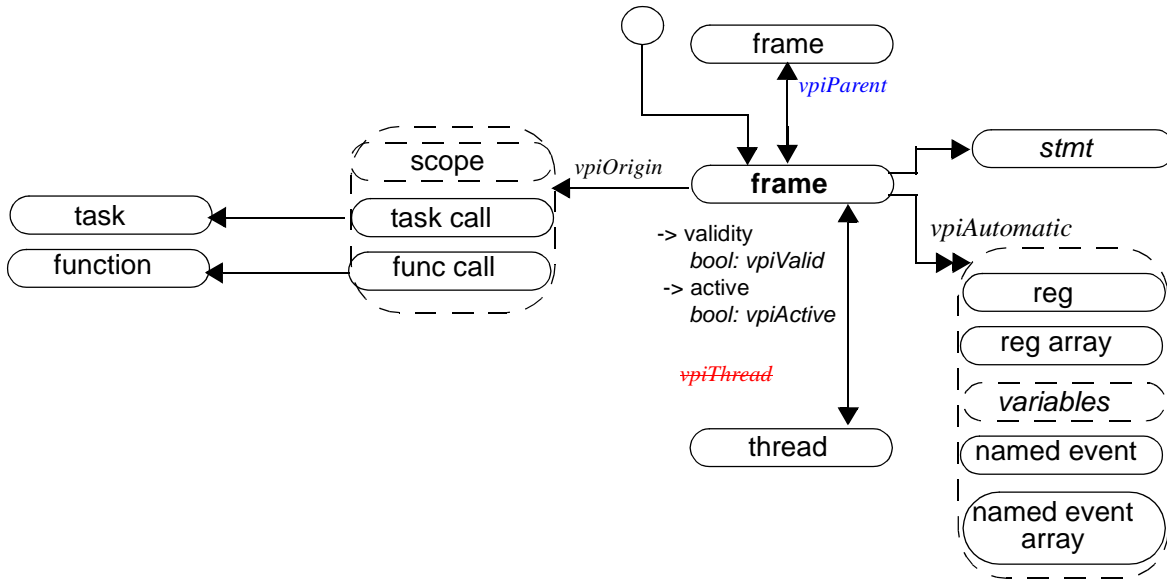

#### NOTES

1) The following callbacks shall be supported on frames:

- **cbStartOfFrame**: triggers whenever any frame gets executed.
- **cbEndOfFrame**: triggers when a particular thread is deleted after all storage is deleted.

*Comment to editors: Please note that we have changed the **vpiParent** handle from the LRM. **vpiOrigin** now gives the originating scope or task/function call. Note also that this diagram is incompatible with the one in IEEE 1364, but the IEEE is currently also making incompatible changes to that diagram.*

### 31.27 Threads

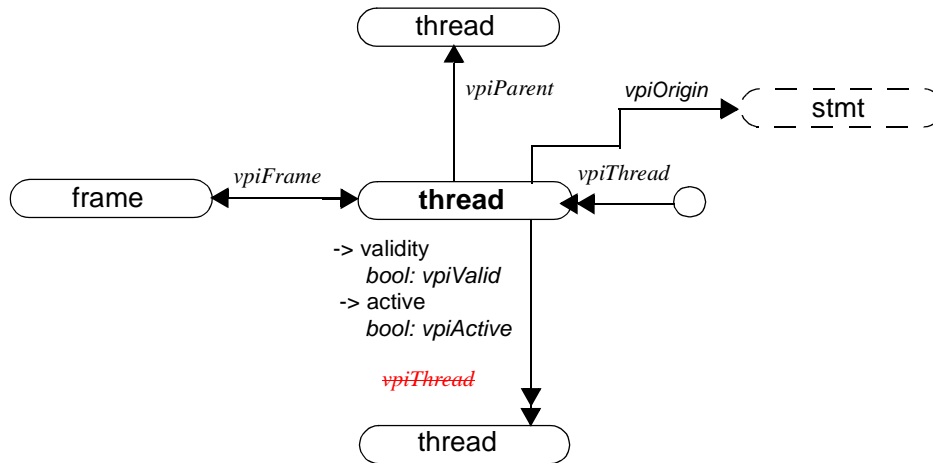

#### NOTES

The following callbacks shall be supported on threads

- **cbStartOfThread**: triggers whenever any thread is created
- **cbEndOfThread**: triggers when a particular thread gets deleted after storage is deleted.
- **cbEnterThread**: triggers whenever a particular thread resumes execution



### 31.28 tf call (supersedes IEEE 1364-2001 26.6.19)

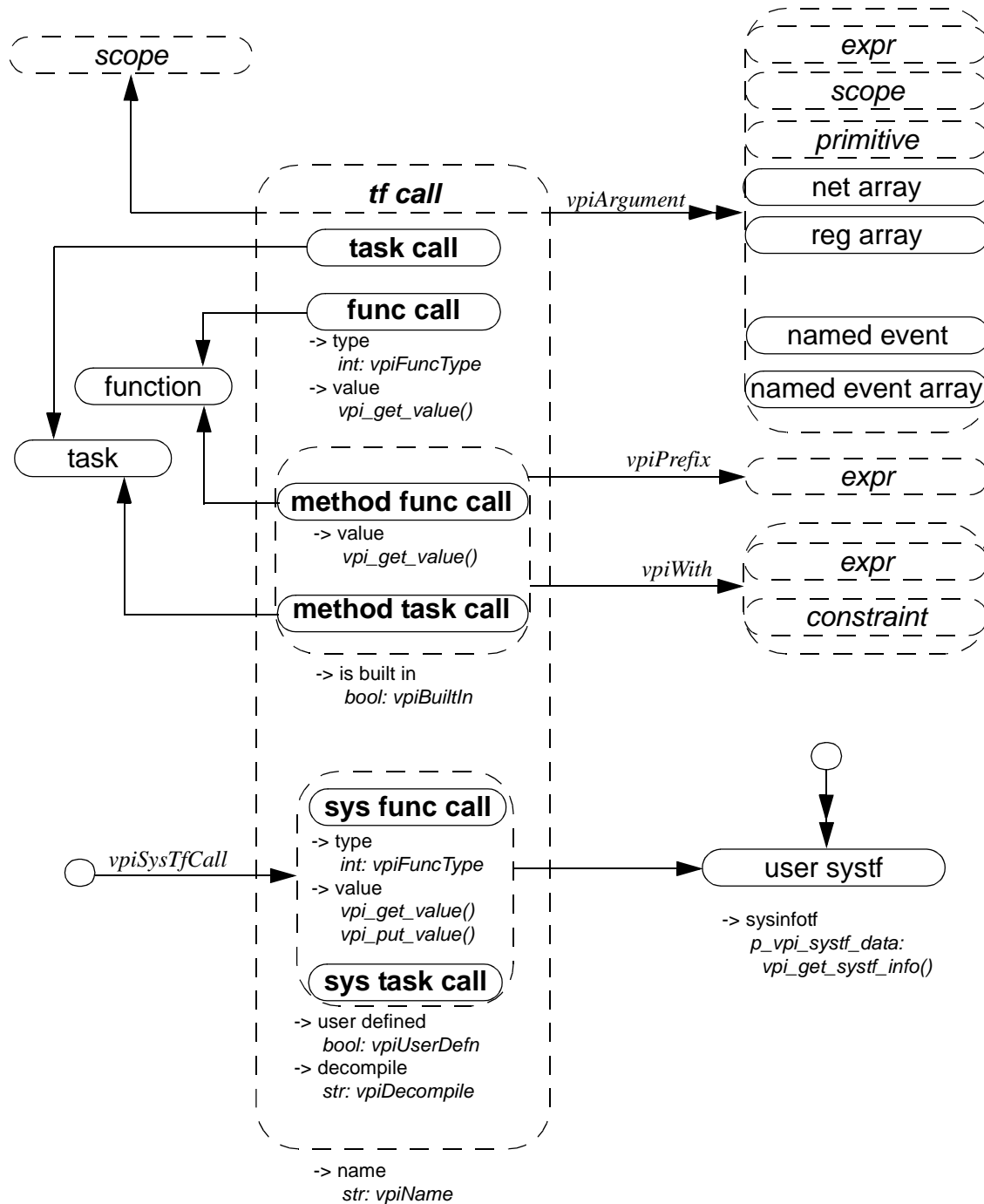

NOTE:

- 1) the **vpiWith** relation is only available for randomize methods (see section 12.6) and for array locator methods (see section 4.15.1).
- 2) For methods (method func call, method task call), the **vpiPrefix** relation will return the object to which the method is being applied. For example, for the class method invocation `packet.send();` the prefix for the "send" method is the class var "packet"

31.29 Module path, path term (supersedes IEEE 1364-2001 26.6.15)

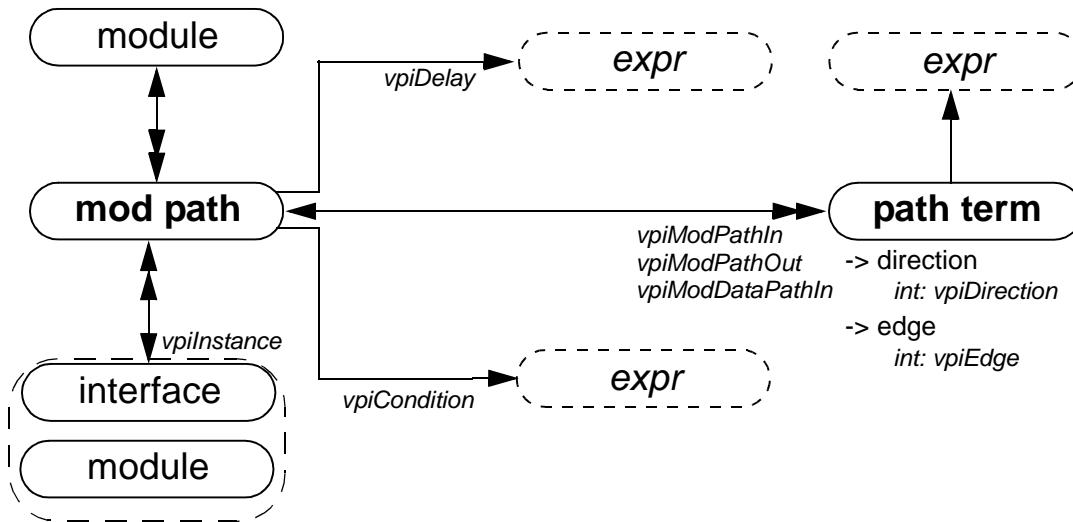

mod path properties:

- > delay
  - vpi\_get\_delays()*
  - vpi\_put\_delays()*
- > path type
  - int: vpiPathType*
- > polarity
  - int: vpiPolarity*
  - int: vpiDataPolarity*
- > hasIfNone
  - bool: vpiModPathHasIfNone*

NOTE:

- 1) specify blocks can occur in both modules and interfaces. For backwards compatibility the **vpiModule** relation has been preserved; however this relation will return **NULL** for specify blocks in interfaces. For new code it is recommended that the **vpiInstance** relation be used instead.

### 31.30 Concurrent assertions

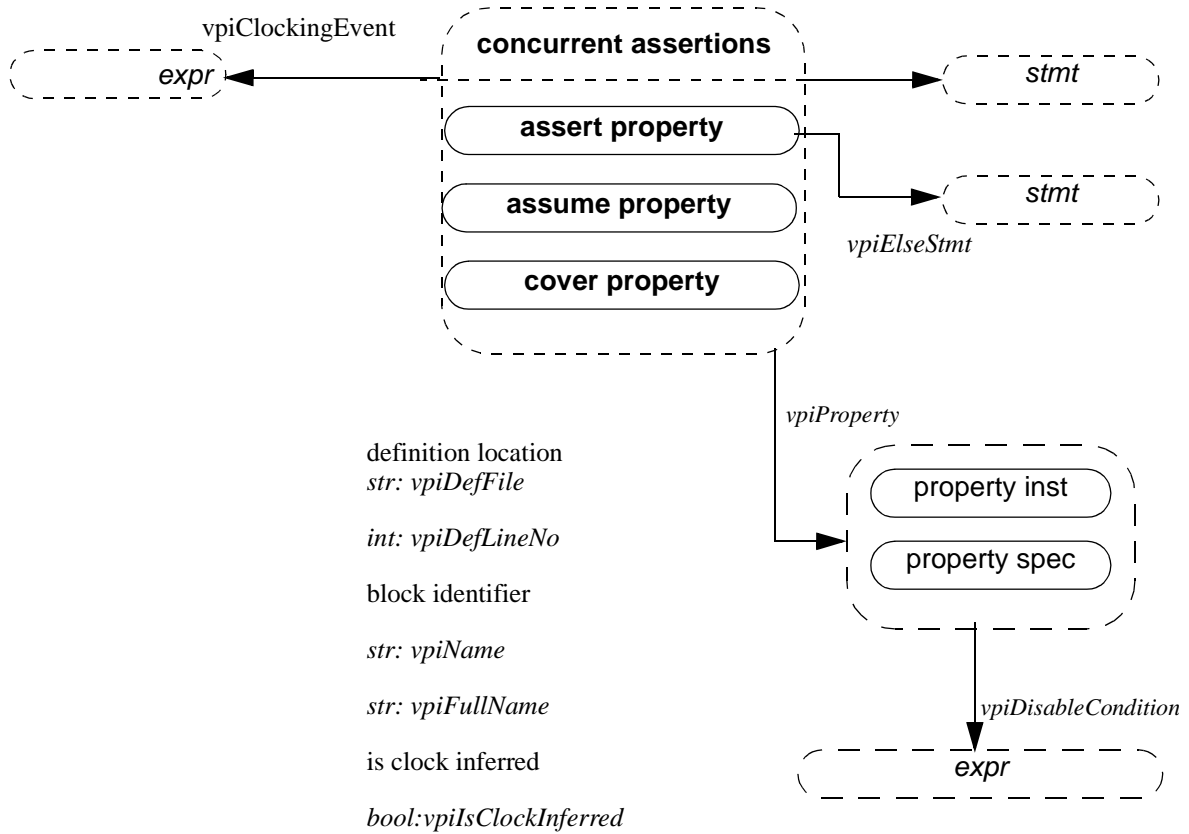

NOTE

Clocking event is always the actual clocking event on which the assertion is being evaluated, regardless of whether this is explicit or implicit (inferred)

### 31.31 Property Decl

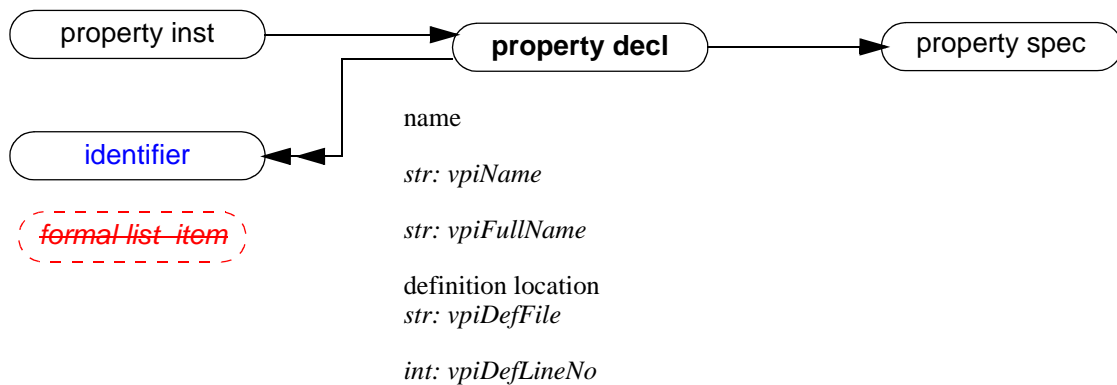

### 31.32 Property Specification

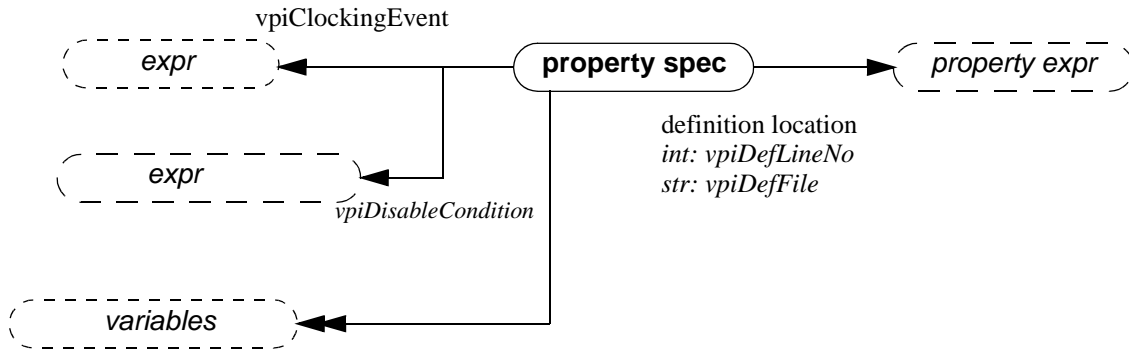

NOTE

Variables are declarations of property variables. You cannot get the value of these variables.

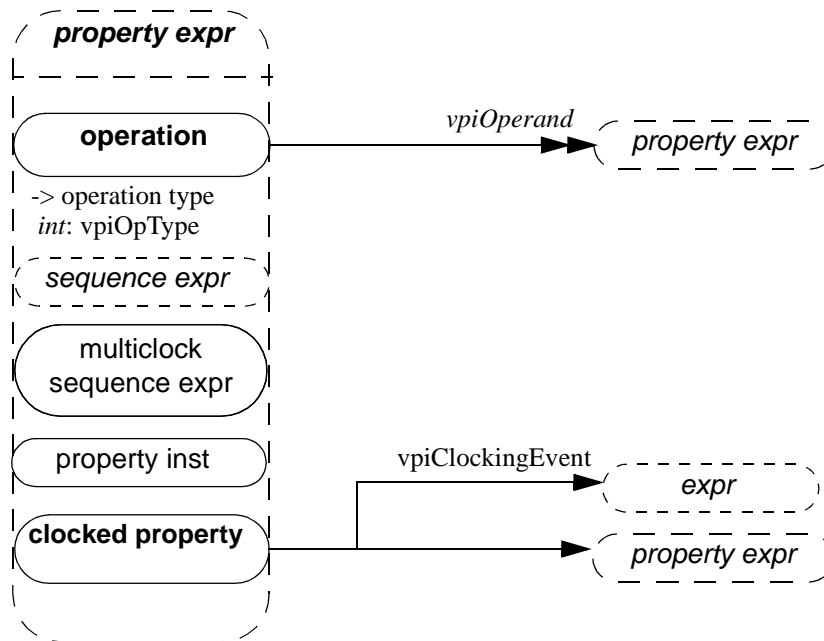

NOTES:

1. within the context of a property expr, **vpiOpType** can be any one of vpiNotOp, vpiImplyOp, vpiDelayedImplyOp, vpiAndOp, vpiOrOp, vpiIfOp, vpiIfElseOp  
Operands to these operations will be provided in the same order as show in the BNF.

### 31.33 Multiclock Sequence Expression

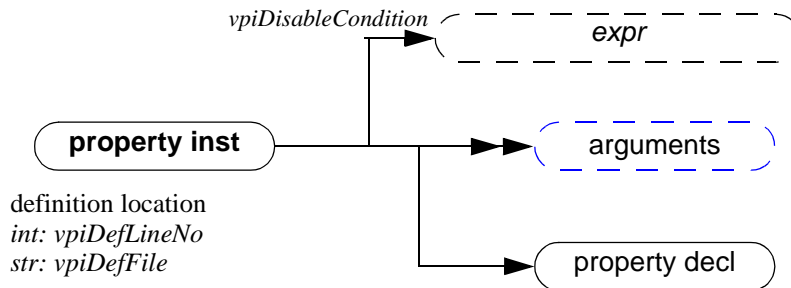
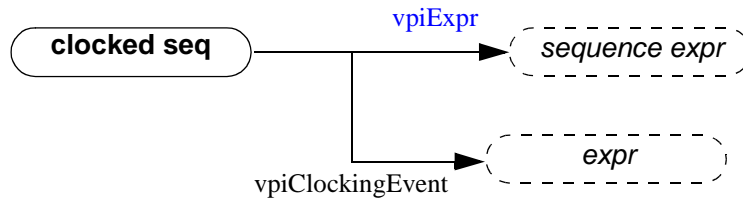
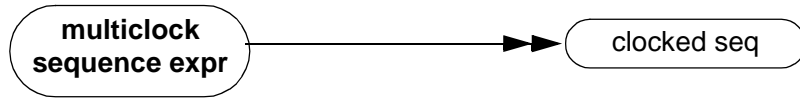

### 31.34 Sequence Declaration

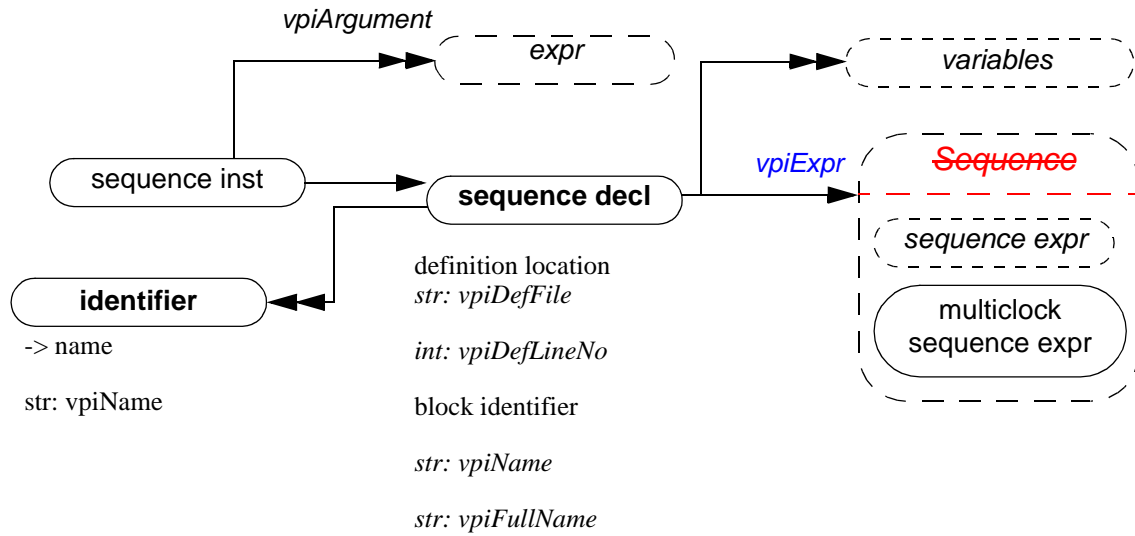

**NOTE:**

the *vpiArgument* iterator shall return the sequence instance arguments in the order that the formals for the sequence are declared, so that the correspondence between each argument and its respective formal can be made. If a formal has a default value, that value will appear as the argument should the instantiation not provide a value for that argument.

### 31.35 Sequence Expression

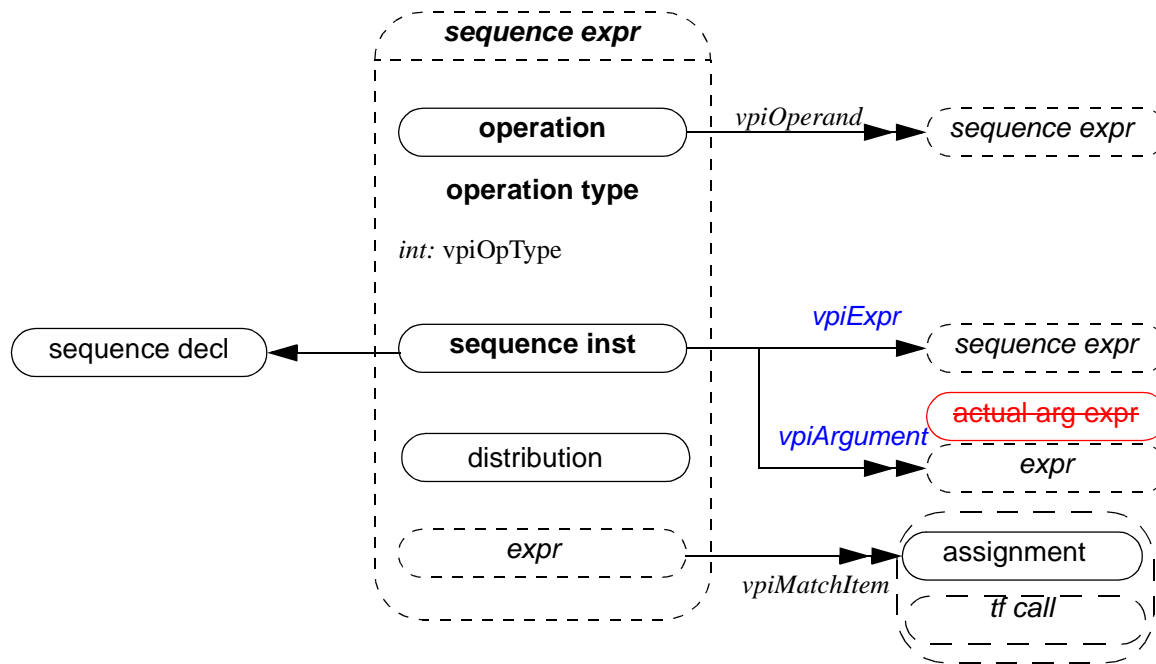

Notes:

2. Within a sequence expression, **vpiOpType** can be any one of vpiAndOp, vpiIntersectOp, vpiOr, vpiFirstMatchOp, vpiThroughoutOp, vpiWithinOp, vpiUnaryCycleDelayOp, vpiCycleDelayOp, vpiRepeatOp, vpiConsecutiveRepeatOp or vpiGotoRepeatOp.
3. For operations, the operands are provided in the same order as the operands appear in BNF, with the following exceptions:  
**vpiUnaryCycleDelayOp**: arguments will be: sequence, left range, right range. Right range will only be given if different than left range.  
**vpiCycleDelayOp**: argument will be: LHS sequence, rhs sequence, left range, right range. Right range will only be provided if different than left range.  
all the repeat operators: the first argument will be the sequence being repeated, the next argument will be the left repeat bound, followed by the right repeat bound. The right repeat bound will only be provided if different than left repeat bound.

and, intersect, or,  
first\_match,  
throughout, within,  
##,  
[\*], [\*=], [\*->]

LRM 209



**31.36 Attribute (supersedes IEEE 1364-2001 26.6.42)**

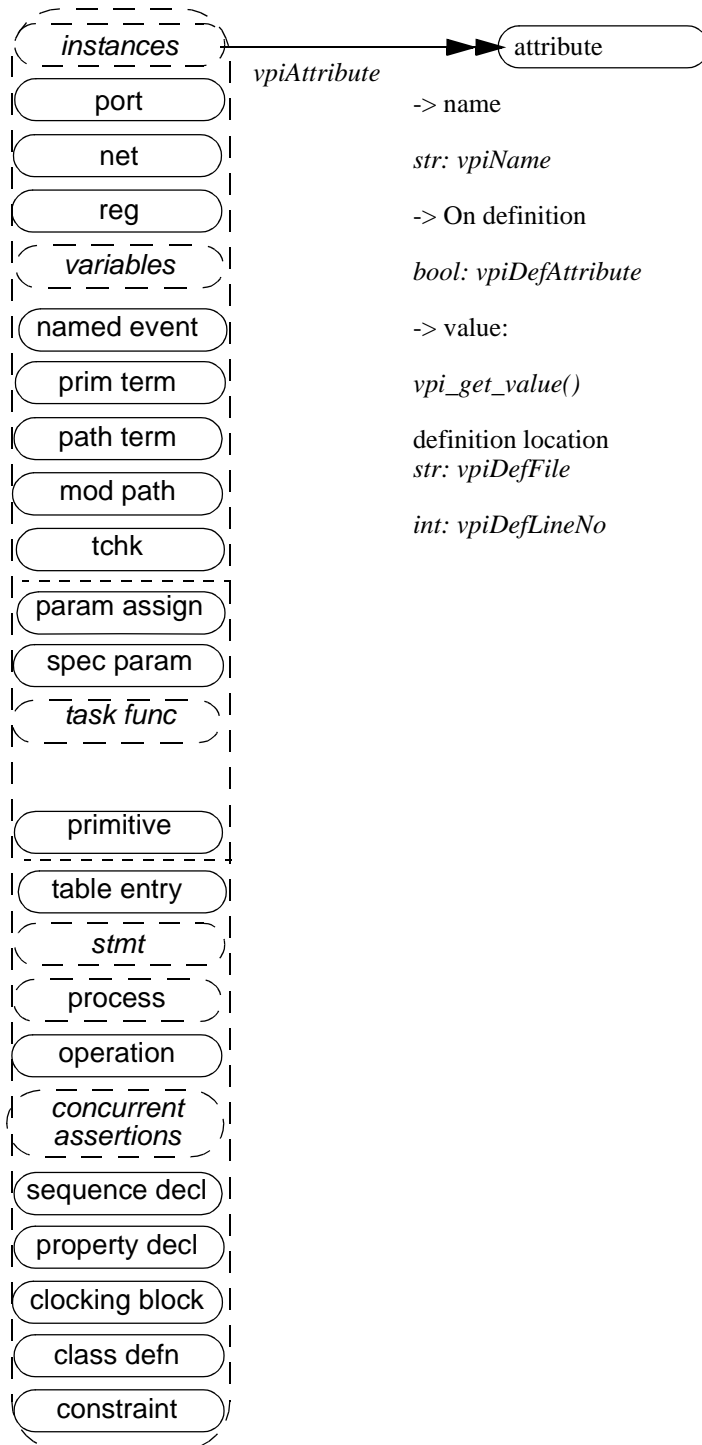



### 31.37 Atomic Statement (supersedes IEEE 1364-2001 26.6.27)

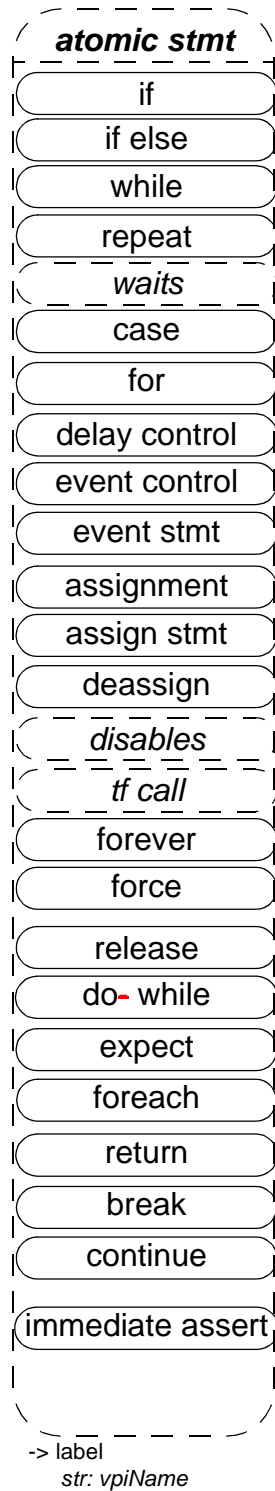

The vpiName property provides the statement label if one was given, otherwise the name is NULL.

31.38 If, if else, return, case, do while (supersedes IEEE 1364-2001 26.6.35, 26.6.36)

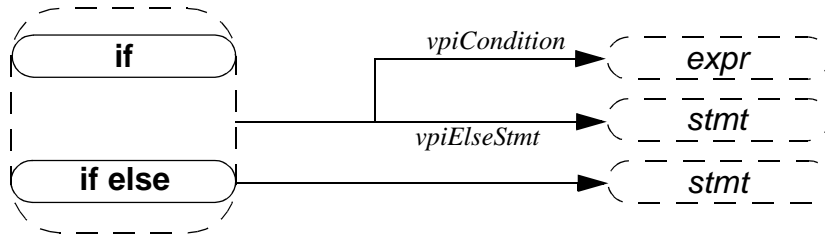

-> qualifier  
int: *vpiQualifier*

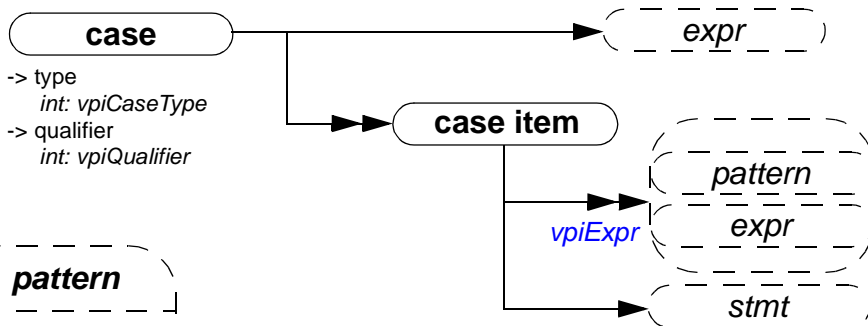
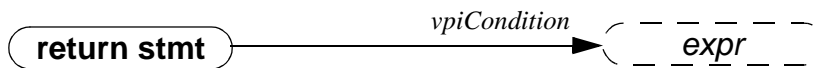

-> type  
int: *vpiCaseType*  
-> qualifier  
int: *vpiQualifier*

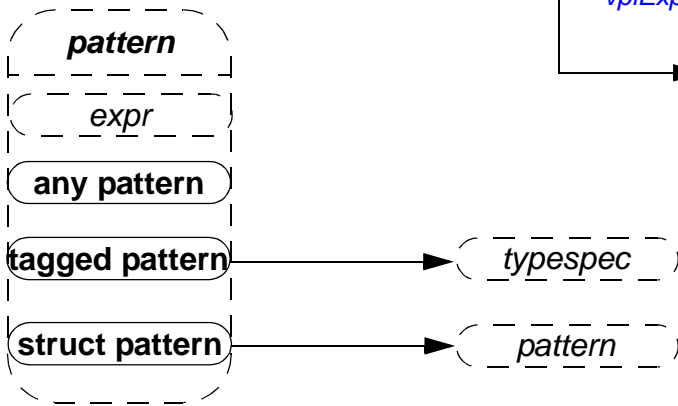

-> name  
str: *vpiName*

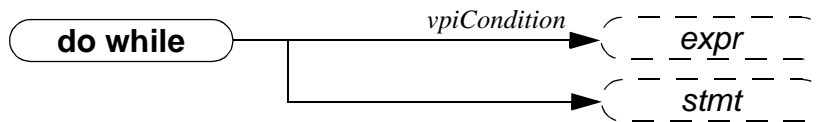

### 31.39 waits, disables, expect, foreach (supersedes IEEE 1364 26.6.38)

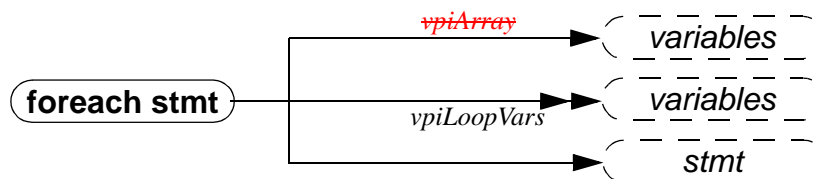
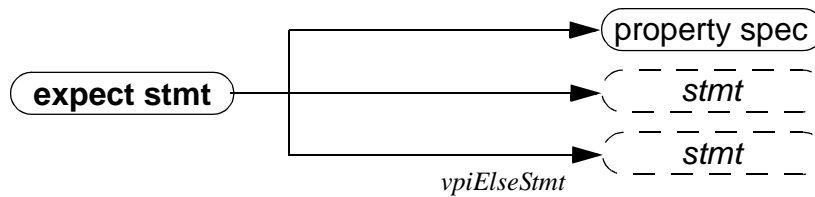
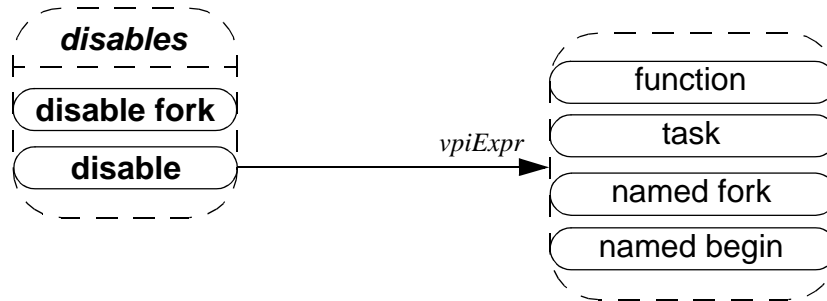
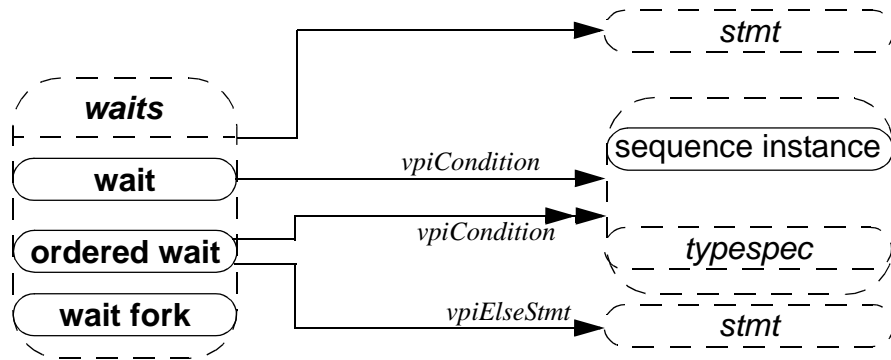

Note that the variable obtained via the **vpiVariable** relation from a **foreach stmt** will always be of type **vpiArrayVar**

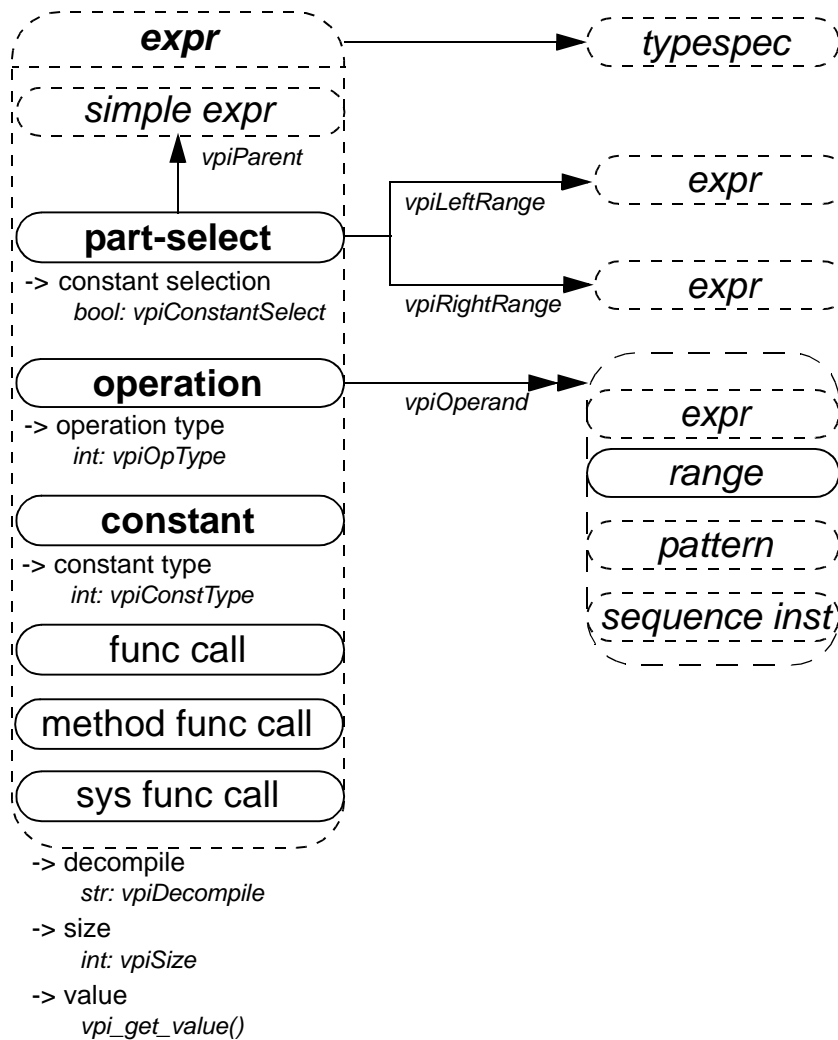
**31.40 Expressions (supersedes IEEE 1364-2001 26.6.26)**

## NOTES:

- 1) For an operator whose type is **vpiMultiConcat**, the first operand shall be the multiplier expression. The remaining operands shall be the expressions within the concatenation.
- 2) The property **vpiDecompile** will return a string with a functionally equivalent expression to the original expression within the HDL. Parenthesis shall be added only to preserve precedence. Each operand and operator shall be separated by a single space character. No additional white space shall be added due to parenthesis.
- 3) new *vpiOpTypes*: *vpiInsideOp*, *vpiMatchOp*, *vpiCastOp*, *vpiPreIncOp*, *vpiPostIncOp*, *vpiPreDecOp*, *vpiPostDecOp*, *vpiIffOp*, *vpiCycleDelayOp*. The cast operation is represented as a unary operation, with its sole argument being the expression being cast, and the *typespec* of the cast expression being the type to which the argument is being cast.
- 4) new *vpiConstType*: *vpiNullConst*, *vpiOneStepConst*, *vpiUnboundedConst*. The constant *vpiUnboundedConst* represents the \$ value used in assertion ranges.
- 5) the one to one relation to *typespec* must always be available for *vpiCastOp* operations and for simple expressions. For other expressions it is implementation dependent whether there is any associated *typespec*.
- 6) Variable slices are represented by part-selects whose parent simple expression is an array variable.

### 31.41 Event control (supersedes IEEE 1364-2001 26.6.30)

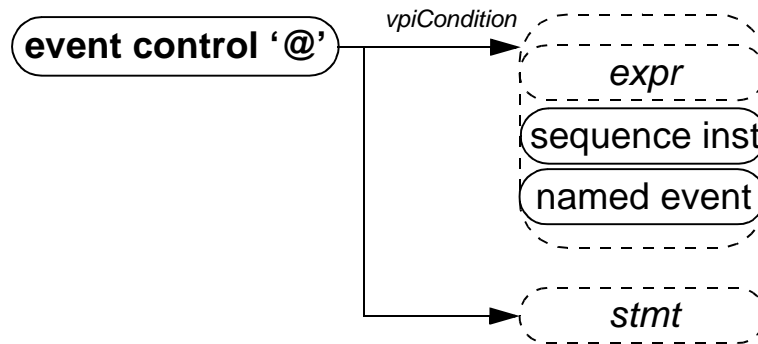

NOTE—For event control associated with assignment, the statement shall always be NULL.

### 31.42 Event stmt (supersedes IEEE 1364-2001 26.6.27)

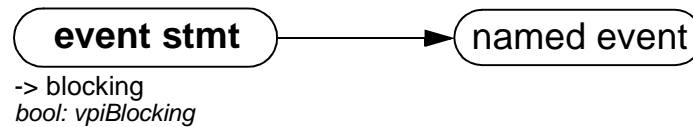

### 31.43 Process (supersedes IEEE 1364-2001 26.6.27)

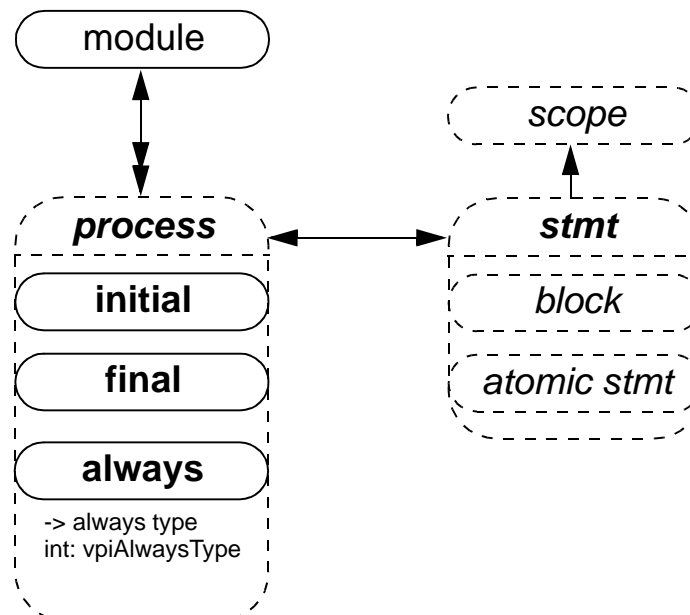

NOTE- vpiAlwaysType can be one of: vpiAlwaysComb, vpiAlwaysFF, vpiAlwaysLatch

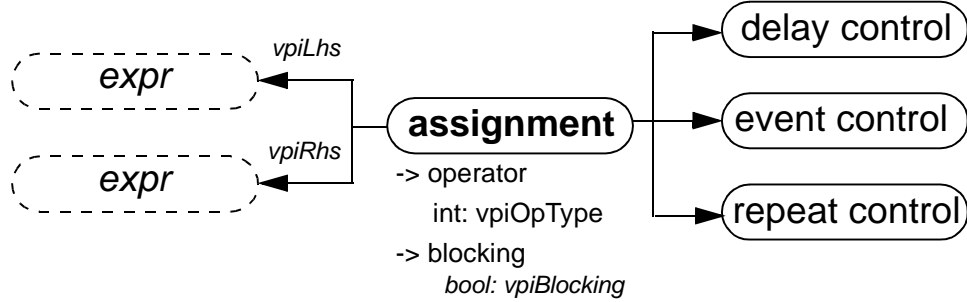
**31.44 Assignment (supersedes IEEE 1364-2001 26.6.28)**

NOTE: *vpiOpType* will return *vpiAssignmentOp* for normal non-blocking '=' assignments, and the operator combined with the assignment for the operators described in section 7.3.

For example, the assignment

```
a[i] += 2;
```

will return *vpiAddOp* for the *vpiOpType* property.

## Annex A Formal Syntax

(Normative)

The formal syntax of SystemVerilog is described using Backus-Naur Form (BNF). The conventions used are:

- Keywords and punctuation are in **bold** text.
- Syntactic categories are named in non-bold text.
- A vertical bar ( | ) separates alternatives.
- Square brackets ( [ ] ) enclose optional items.
- Braces ( { } ) enclose items which can be repeated zero or more times.

The full syntax and semantics of Verilog and SystemVerilog are not described solely using BNF. The normative text description contained within the chapters of the IEEE 1364-2001 Verilog standard and this SystemVerilog document provide additional details on the syntax and semantics described in this BNF.

### A.1 Source text

#### A.1.1 Library source text

library\_text ::= { library\_descriptions }

library\_descriptions ::=

library\_declaration  
| include\_statement  
| config\_declaration

library\_declaration ::=

**library** library\_identifier file\_path\_spec { , file\_path\_spec }  
[ **-incdir** file\_path\_spec { , file\_path\_spec } ] ;

file\_path\_spec ::= file\_path

include\_statement ::= **include** file\_path\_spec ;

LRM 39

#### A.1.2 Configuration source text

config\_declaration ::=

**config** config\_identifier ;  
design\_statement  
{ config\_rule\_statement }

**endconfig** [ : config\_identifier ]

design\_statement ::= **design** { [ library\_identifier . ] cell\_identifier } ;

config\_rule\_statement ::=

default\_clause liblist\_clause  
| inst\_clause liblist\_clause  
| inst\_clause use\_clause  
| cell\_clause liblist\_clause  
| cell\_clause use\_clause

default\_clause ::= **default**

inst\_clause ::= **instance** inst\_name

inst\_name ::= topmodule\_identifier { . instance\_identifier }

cell\_clause ::= **cell** [ library\_identifier . ] cell\_identifier

liblist\_clause ::= **liblist** { library\_identifier }

use\_clause ::= **use** [ library\_identifier . ] cell\_identifier [ : **config** ]

LRM 270

**A.1.3 Module and primitive source text**

```

source_text ::= [timeunits_declaration] { description }
description ::=
 module_declaration
 | udp_declaration
 | interface_declaration
 | program_declaration
 | package_declaration
 | { attribute_instance } package_item
 | { attribute_instance } bind_directive
 | { attribute_instance } ;

module_nonansi_header ::=
 { attribute_instance } module_keyword [lifetime] module_identifier [parameter_port_list]
 list_of_ports ;

module_ansi_header ::=
 { attribute_instance } module_keyword [lifetime] module_identifier [parameter_port_list]
 [list_of_port_declarations] ;

module_declaration ::=
 module_nonansi_header [timeunits_declaration] { module_item }
 endmodule [: module_identifier]
 | module_ansi_header [timeunits_declaration] { non_port_module_item }
 endmodule [: module_identifier]
 | { attribute_instance } module_keyword [lifetime] module_identifier (.*);
 [timeunits_declaration] { module_item } endmodule [: module_identifier]
 | extern module_nonansi_header
 | extern module_ansi_header

module_keyword ::= module | macromodule

interface_nonansi_header ::=
 { attribute_instance } interface [lifetime] interface_identifier
 [parameter_port_list] list_of_ports ;

interface_ansi_header ::=
 { attribute_instance } interface [lifetime] interface_identifier
 [parameter_port_list] [list_of_port_declarations] ;

interface_declaration ::=
 interface_nonansi_header [timeunits_declaration] { interface_item }
 endinterface [: interface_identifier]
 | interface_ansi_header [timeunits_declaration] { non_port_interface_item }
 endinterface [: interface_identifier]
 | { attribute_instance } interface interface_identifier (.*);
 [timeunits_declaration] { interface_item }
 endinterface [: interface_identifier]
 | extern interface_nonansi_header
 | extern interface_ansi_header

program_nonansi_header ::=
 { attribute_instance } program [lifetime] program_identifier
 [parameter_port_list] list_of_ports ;

program_ansi_header ::=
 { attribute_instance } program [lifetime] program_identifier
 [parameter_port_list] [list_of_port_declarations] ;

program_declaration ::=
 program_nonansi_header [timeunits_declaration] { program_item }

```



```

endprogram [: program_identifier]
| program_ansi_header [timeunits_declaration] { non_port_program_item }
endprogram [: program_identifier]
| { attribute_instance } program program_identifier (.*);
| [timeunits_declaration] { program_item }
endprogram [: program_identifier]
| extern program_nonansi_header
| extern program_ansi_header

```

class\_declaration ::=

```

[virtual] class [lifetime] class_identifier [parameter_port_list]
[extends class_identifier [parameter_value_assignment]] [(list_of_arguments)] ;
[extends class_type [(list_of_arguments)]] ;
{ class_item }
endclass [: class_identifier]

```

LRM 58

LRM 174

LRM 34

LRM 216

LRM 249

package\_declaration ::=

```

{ attribute_instance } package package_identifier ;
| [timeunits_declaration] { { attribute_instance } package_item }
endpackage [: package_identifier]

```

LRM 58

LRM 249

timeunits\_declaration ::=

```

timeunit time_literal ;
| timeprecision time_literal ;
| timeunit time_literal ;
| timeprecision time_literal ;
| timeprecision time_literal ;
| timeunit time_literal ;

```

#### A.1.4 Module parameters and ports

parameter\_port\_list ::=

```

(list_of_param_assignments { , parameter_port_declaration })
| # (parameter_port_declaration { , parameter_port_declaration })

```

LRM 58

parameter\_port\_declaration ::=

```

parameter_declaration
| data_type list_of_param_assignments
| type list_of_type_assignments

```

LRM 58

list\_of\_ports ::= ( port { , port } )

list\_of\_port\_declarations<sup>27</sup> ::=

```

([{ attribute_instance } ansi_port_declaration { , { attribute_instance } ansi_port_declaration }])

```

LRM 10

~~non\_generic\_port\_declaration~~ port\_declaration ::=

```

{ attribute_instance } inout_declaration
| { attribute_instance } input_declaration
| { attribute_instance } output_declaration
| { attribute_instance } ref_declaration
| { attribute_instance } interface_port_declaration

```

LRM 243

port ::=

```

[port_expression]
| . port_identifier ([port_expression])

```

port\_expression ::=

```

port_reference
| { port_reference { , port_reference } }

```

port\_reference ::=

```

port_identifier [[constant_range_expression]]

```

|                                                                                                                                                                                                                                                                                                 |         |
|-------------------------------------------------------------------------------------------------------------------------------------------------------------------------------------------------------------------------------------------------------------------------------------------------|---------|
| <del>port_declaration ::=</del><br><del>non_generic_port_declaration</del><br>† { attribute_instance } generic_interface_port_declaration                                                                                                                                                       | LRM 243 |
| <del>ansi_port_declaration ::=</del><br><del>port_declaration</del><br>† <del>port_type list_of_port_identifiers</del>                                                                                                                                                                          | LRM 10  |
| port_direction ::= <b>input</b>   <b>output</b>   <b>inout</b>   <b>ref</b>                                                                                                                                                                                                                     | LRM 243 |
| net_port_header ::= [ port_direction ] port_type                                                                                                                                                                                                                                                |         |
| variable_port_header ::= [ port_direction ] data_type                                                                                                                                                                                                                                           |         |
| interface_port_header ::=<br>interface_identifier [ . modport_identifier ]<br>  <b>interface</b> [ . modport_identifier ]                                                                                                                                                                       |         |
| ansi_port_declaration ::=<br>[ net_port_header   interface_port_header ] port_identifier { unpacked_dimension }<br>  [ variable_port_header ] port_identifier variable_dimension [ = constant_expression ]<br>  [ net_port_header   variable_port_header ] . port_identifier ( [ expression ] ) |         |

### A.1.5 Module items

|                                                                                                                                                                                                                                                                                                                                                                                              |                            |
|----------------------------------------------------------------------------------------------------------------------------------------------------------------------------------------------------------------------------------------------------------------------------------------------------------------------------------------------------------------------------------------------|----------------------------|
| module_common_item ::=<br>module_or_generate_item_declaration<br>  interface_instantiation<br>  program_instantiation<br>  concurrent_assertion_item<br>  bind_directive<br>  continuous_assign<br>  net_alias<br>  initial_construct<br>  final_construct<br>  always_construct<br>† <del>combinational_construct</del><br>† <del>latch_construct</del><br>† <del>ff_construct</del><br>  ; | LRM 100                    |
| module_item ::=<br><del>non_generic_port_declaration</del> port_declaration ;<br>  non_port_module_item                                                                                                                                                                                                                                                                                      | LRM 243                    |
| module_or_generate_item ::=<br>{ attribute_instance } parameter_override<br>  { attribute_instance } gate_instantiation<br>  { attribute_instance } udp_instantiation<br>  { attribute_instance } module_instantiation<br>  { attribute_instance } module_common_item                                                                                                                        | LRM 100                    |
| module_or_generate_item_declaration ::=<br>package_or_generate_item_declaration<br>  genvar_declaration<br>  <del>clocking_declaration</del> -<br>  <b>default clocking</b> clocking_identifier ;                                                                                                                                                                                            | LRM 270                    |
| non_port_module_item ::=<br>generated_module_instantiation<br>  module_or_generate_item<br>  specify_block                                                                                                                                                                                                                                                                                   | LRM 39<br>LRM 58<br>LRM 99 |

```

 | { attribute_instance } specparam_declaration
 | program_declaration
 | module_declaration
 | timeunits_declaration19

```

parameter\_override ::= **defparam** list\_of\_defparam\_assignments ;

```

bind_directive ::=
 bind module_identifier bind_instantiation ;
 | bind name_of_instance bind_instantiation ;

```

```

bind_instantiation ::=
 program_instantiation
 | module_instantiation
 | interface_instantiation

```

### A.1.6 Interface items

```

interface_or_generate_item ::=
 { attribute_instance } module_common_item
 | { attribute_instance } modport_declaration
 | { attribute_instance } extern_tf_declaration

```

LRM 58

```

extern_tf_declaration ::=
 extern method_prototype
 | extern forkjoin task named_task_proto ;

```

```

interface_item ::=
 non_generic_port_declaration port_declaration ;
 | non_port_interface_item

```

LRM 243

```

non_port_interface_item ::=
 generated_interface_instantiation
 | { attribute_instance } specparam_declaration
 | interface_or_generate_item
 | program_declaration
 | interface_declaration
 | timeunits_declaration19

```

LRM 39  
LRM 58  
LRM 99

### A.1.7 Program items

```

program_item ::=
 port_declaration ;
 | non_port_program_item

```

```

non_port_program_item ::=
 { attribute_instance } continuous_assign
 | { attribute_instance } module_or_generate_item_declaration
 | { attribute_instance } specparam_declaration
 | { attribute_instance } local_parameter_declaration
 | { attribute_instance } parameter_declaration
 | { attribute_instance } initial_construct
 | { attribute_instance } concurrent_assertion_item
 | { attribute_instance } timeunits_declaration19
 | class_declaration

```

LRM 242  
LRM 250

LRM 99

### A.1.8 Class items

```

class_item ::=
 { attribute_instance } class_property
 | { attribute_instance } class_method
 | { attribute_instance } class_constraint

```

```

 | { attribute_instance } type_declaration
 | { attribute_instance } class_declaration
 | { attribute_instance } timeunits_declaration19
class_property ::=
 { property_qualifier } data_declaration
 | const { class_item_qualifier } data_type const_identifier [= constant_expression] ;
class_method ::=
 { method_qualifier } task_declaration
 | { method_qualifier } function_declaration
 | extern { method_qualifier } method_prototype
 | { method_qualifier } class_constructor_declaration
 | extern { method_qualifier } class_constructor_prototype
class_constructor_prototype ::=
 function new ([tf_port_list]) ;
class_constraint ::=
 constraint_prototype
 | constraint_declaration
class_item_qualifier8 ::=
 static
 | protected
 | local
property_qualifier8 ::=
 rand
 | randc
 | class_item_qualifier
method_qualifier8 ::=
 virtual
 | class_item_qualifier
method_prototype ::=
 task named_task_proto ;
 | function named_function_proto ;
extern_method_declaration ::=
 function [lifetime] class_identifier ** function_body_declaration
 | task [lifetime] class_identifier ** task_body_declaration
class_constructor_declaration ::=
 function [class_scope] new [([tf_port_list])] ;
 { block_item_declaration }
 [super . new [(list_of_arguments)] ;]
 { function_statement_or_null }
endfunction [: new]

```

LRM 65

LRM 99

LRM 117

LRM 250

LRM 249

LRM 117

LRM 250

### A.1.9 Constraints

```

constraint_declaration ::= [static] constraint constraint_identifier { { constraint_block } }
constraint_block ::=
 solve identifier_list before identifier_list ;
 | constraint_expression
constraint_expression ::=
 expression ;
 | expression -> constraint_set
 | if (expression) constraint_set [else constraint_set]

```

```

| expression dist { dist_list };
| foreach (array_identifier [loop_variables]) constraint_set

```

LRM 63  
LRM 70  
LRM 71

```

constraint_set ::=
 constraint_expression
| { { constraint_expression } }

```

```

dist_list ::= dist_item { , dist_item }

```

```

dist_item ::= value_range [dist_weight]
value_range ::= expression
| value_range / expression

```

LRM 273

```

dist_weight ::=
 := expression
| / expression

```

```

constraint_prototype ::= [static] constraint constraint_identifier

```

```

extern_constraint_declaration ::=
 [static] constraint class_identifier :: constraint_identifier { { constraint_block } }

```

```

identifier_list ::= identifier { , identifier }

```

### A.1.10 Package items

```

package_item ::=
 package_or_generate_item_declaration
| specparam_declaration
| concurrent_assertion_item_declaration
| anonymous_program
| timeunits_declaration19

```

LRM 58  
LRM 65  
LRM 77  
LRM 99

```

package_or_generate_item_declaration ::=
 net_declaration
| data_declaration
| task_declaration
| function_declaration
| dpi_import_export
| extern_constraint_declaration
| extern_method_declaration
| class_declaration
| class_constructor_declaration
| parameter_declaration ;
| local_parameter_declaration
| covergroup_declaration
| overload_declaration
| concurrent_assertion_item_declaration

```

LRM 240  
LRM 249  
LRM 250

```

anonymous_program ::= program ; { anonymous_program_item } endprogram

```

```

anonymous_program_item ::=
 task_declaration
| function_declaration
| class_declaration
| covergroup_declaration
| class_constructor_declaration

```

LRM 250

## A.2 Declarations

### A.2.1 Declaration types

#### A.2.1.1 Module parameter declarations

local\_parameter\_declaration ::=

~~localparam~~ [ signing ] { packed\_dimension } list\_of\_param\_assignments ;  
 † localparam data\_type\_or\_implicit list\_of\_param\_assignments ;

LRM 243

parameter\_declaration ::=

~~parameter~~ [ signing ] { packed\_dimension } list\_of\_param\_assignments  
 † parameter data\_type\_or\_implicit list\_of\_param\_assignments  
 | parameter type list\_of\_type\_assignments

LRM 243

specparam\_declaration ::=

specparam [ packed\_dimension ] list\_of\_specparam\_assignments ;

### A.2.1.2 Port declarations

inout\_declaration ::=

inout { port\_type } list\_of\_port\_identifiers

LRM 31

input\_declaration ::=

input { port\_type } list\_of\_port\_identifiers  
 | input data\_type list\_of\_variable\_identifiers

LRM 243

output\_declaration ::=

output { port\_type } list\_of\_port\_identifiers  
 | output data\_type list\_of\_variable\_port\_identifiers

interface\_port\_declaration ::=

interface\_identifier list\_of\_interface\_identifiers  
 | interface\_identifier . modport\_identifier list\_of\_interface\_identifiers

ref\_declaration ::= **ref** data\_type list\_of\_port\_identifiers

~~generic\_interface\_port\_declaration ::=~~

~~interface~~ list\_of\_interface\_identifiers  
 † ~~interface~~ . modport\_identifier list\_of\_interface\_identifiers

LRM 243

### A.2.1.3 Type declarations

data\_declaration<sup>16</sup> ::=

[ **const** ] [ lifetime ] variable\_declaration  
 | type\_declaration  
 | package\_import\_declaration  
 | virtual\_interface\_declaration

LRM 35

package\_import\_declaration ::=

**import** package\_import\_item { , package\_import\_item } ;

package\_import\_item ::=

package\_identifier :: identifier  
 | package\_identifier :: \*

LRM 58  
LRM 59  
LRM 74  
LRM 90

genvar\_declaration ::= **genvar** list\_of\_genvar\_identifiers ;

net\_declaration<sup>15</sup> ::=

net\_type\_or\_trireg [ drive\_strength | charge\_strength ] [ **vectored** | **scalared** ]  
 [ signing ] { packed\_dimension } [ delay3 ] list\_of\_net\_decl\_assignments ;

LRM 45

type\_declaration ::=

**typedef** data\_type type\_identifier variable\_dimension ;  
 | **typedef** interface\_instance\_identifier . type\_identifier type\_identifier ;  
 | **typedef** [ **enum** | **struct** | **union** | **class** ] type\_identifier ;

LRM 89

variable\_declaration ::=

data\_type list\_of\_variable\_decl\_assignments ;

LRM 22  
LRM 35

lifetime ::= **static** | **automatic**

LRM 35

## A.2.2 Declaration data types

### A.2.2.1 Net and variable types

casting\_type ::= simple\_type | size | signing

LRM 76

```
data_type_common_item data_type ::=
 integer_vector_type [signing] { packed_dimension }
 | integer_atom_type [signing]
 | type_identifier { packed_dimension }
 | non_integer_type
 | struct_union [packed [signing]] { struct_union_member { struct_union_member } }
 { packed_dimension }14
 | enum [enum_base_type] { enum_name_declaration { , enum_name_declaration } }
 | string
 | chandle
 | virtual [interface] interface_identifier
 | [class_scope | package_scope] type_identifier { packed_dimension }
 | class_type
 | event
 | ps_covergroup_identifier
```

LRM 243  
LRM 249

LRM 45  
LRM 59  
LRM 65  
LRM 72  
LRM 82

```
data_type ::=
data_type_common_item
event
class_scope_type_identifier
covergroup_identifier
```

```
data_type_or_implicit ::=
 data_type
 | [signing] { packed_dimension }
```

LRM 243  
LRM 249

```
enum_base_type ::=
 integer_atom_type [signing]
 | integer_vector_type [signing] [packed_dimension]
 | type_identifier [packed_dimension]25
```

LRM 170

```
enum_name_declaration ::=
 enum_identifier [[integral_number [: integral_number]]] [= constant_expression]
```

LRM 125

LRM 147

```
class_scope_type_identifier ::=
class_scope { :: type_identifier }
```

LRM 249

```
class_scope ::=
class_identifier { parameter_value_assignment }
 { :: class_identifier { parameter_value_assignment } }
```

LRM 45  
LRM 59  
LRM 69

```
class_scope ::= class_type ::
```

LRM 249

```
class_type ::=
 ps_class_identifier [parameter_value_assignment]
 { :: class_identifier [parameter_value_assignment] }
```

```
integer_type ::= integer_vector_type | integer_atom_type
```

```
integer_atom_type ::= byte | shortint | int | longint | integer | time
```

LRM 241

```
integer_vector_type ::= bit | logic | reg
```

```
non_integer_type ::= time | shortreal | real | realtime
```

```
net_type ::= supply0 | supply1 | tri | triand | trior | tri0 | tri1 | wire | wand | wor
```

```
port_type ::=
data_type
net_type_or_trireg [signing] { packed_dimension }
```

```

† { signing } { packed_dimension }
port_type ::=
 [net_type_or_trireg] [signing] { packed_dimension }

```

LRM 243

```
net_type_or_trireg ::= net_type | trireg
```

```
signing ::= signed | unsigned
```

LRM 243

```
simple_type ::= integer_type | non_integer_type | ps_type_identifier
```

```

struct_union_member28 ::=
 { attribute_instance } data_type { packed_dimension }
 data_type_or_void list_of_variable_identifiers ;
† { attribute_instance } void list_of_variable_identifiers ;

```

LRM 100

LRM 35

LRM 122

```
data_type_or_void ::= data_type | void
```

LRM 246

```
struct_union ::= struct | union [tagged]
```

### A.2.2.2 Strengths

```

drive_strength ::=
 (strength0 , strength1)
 | (strength1 , strength0)
 | (strength0 , highz1)
 | (strength1 , highz0)
 | (highz0 , strength1)
 | (highz1 , strength0)

```

LRM 100

```
strength0 ::= supply0 | strong0 | pull0 | weak0
```

```
strength1 ::= supply1 | strong1 | pull1 | weak1
```

```
charge_strength ::= (small) | (medium) | (large)
```

### A.2.2.3 Delays

```
delay3 ::= # delay_value | # (mintypmax_expression [, mintypmax_expression [, mintypmax_expression]])
```

```
delay2 ::= # delay_value | # (mintypmax_expression [, mintypmax_expression])
```

```

delay_value ::=
 unsigned_number
 | real_number
 | ps_identifier
 | time_literal

```

LRM 247

LRM 249

### A.2.3 Declaration lists

```
list_of_defparam_assignments ::= defparam_assignment { , defparam_assignment }
```

```
list_of_genvar_identifiers ::= genvar_identifier { , genvar_identifier }
```

```
list_of_interface_identifiers ::= interface_identifier { unpacked_dimension }
 { , interface_identifier { unpacked_dimension } }
```

```

list_of_modport_port_identifiers ::= port_identifier { , port_identifier }
† .port_identifier ({ expression }) { .port_identifier ({ expression }) }

```

LRM 243

LRM 32

```
list_of_net_decl_assignments ::= net_decl_assignment { , net_decl_assignment }
```

```
list_of_net_identifiers ::= net_identifier { unpacked_dimension }
 { , net_identifier { unpacked_dimension } }
```

```
list_of_param_assignments ::= param_assignment { , param_assignment }
```

```
list_of_port_identifiers ::= port_identifier { unpacked_dimension }
 { , port_identifier { unpacked_dimension } }
```

LRM 243

```

† .port_identifier ({ expression }) { .port_identifier ({ expression }) }
list_of_udp_port_identifiers ::= port_identifier { , port_identifier }

```

LRM 32



list\_of\_specparam\_assignments ::= specparam\_assignment { , specparam\_assignment }

list\_of\_tf\_variable\_identifiers ::= port\_identifier variable\_dimension [ = expression ]  
 { , port\_identifier variable\_dimension [ = expression ] }

LRM 100

list\_of\_type\_assignments ::= type\_assignment { , type\_assignment }

list\_of\_variable\_decl\_assignments ::= variable\_decl\_assignment { , variable\_decl\_assignment }

list\_of\_variable\_identifiers ::= variable\_identifier variable\_dimension  
 { , variable\_identifier variable\_dimension }

LRM 35

list\_of\_variable\_port\_identifiers ::= port\_identifier variable\_dimension [ = constant\_expression ]  
 { , port\_identifier variable\_dimension [ = constant\_expression ] }

list\_of\_virtual\_interface\_decl ::=  
 variable\_identifier [ = interface\_instance\_identifier ]  
 { , variable\_identifier [ = interface\_instance\_identifier ] }

LRM 72

#### A.2.4 Declaration assignments

defparam\_assignment ::= hierarchical\_parameter\_identifier = constant\_mintypmax\_expression

net\_decl\_assignment ::= net\_identifier { unpacked\_dimension } [ = expression ]

param\_assignment ::= parameter\_identifier { **unpacked\_dimension** } = constant\_param\_expression

specparam\_assignment ::=  
 specparam\_identifier = constant\_mintypmax\_expression  
 | pulse\_control\_specparam

type\_assignment ::= type\_identifier = data\_type

pulse\_control\_specparam ::=  
**PATHPULSE\$** = ( reject\_limit\_value [ , error\_limit\_value ] );  
 | **PATHPULSE\$**specify\_input\_terminal\_descriptor\$specify\_output\_terminal\_descriptor  
 = ( reject\_limit\_value [ , error\_limit\_value ] );

error\_limit\_value ::= limit\_value

reject\_limit\_value ::= limit\_value

limit\_value ::= constant\_mintypmax\_expression

variable\_decl\_assignment ::=  
 variable\_identifier variable\_dimension [ = expression ]  
 | dynamic\_array\_variable\_identifier [ ] [ = dynamic\_array\_new ]  
 | class\_variable\_identifier [ = class\_new ]  
 | [ covergroup\_variable\_identifier ] = **new** [ ( list\_of\_arguments ) ]<sup>17</sup>

class\_new<sup>21</sup> ::= **new** [ ( list\_of\_arguments ) | expression ]

dynamic\_array\_new ::= **new** [ expression ] [ ( **dynamic\_array\_variable\_identifier** expression ) ]

LRM 35

LRM 59  
LRM 61  
LRM 65  
LRM 97

LRM 117

LRM 249

#### A.2.5 Declaration ranges

unpacked\_dimension ::= [ dimension\_constant\_expression : dimension\_constant\_expression ]  
 | [ dimension\_constant\_expression ]

packed\_dimension<sup>12</sup> ::=  
 [ dimension\_constant\_expression : dimension\_constant\_expression ]  
 | **unsized\_dimension**

LRM 17

range ::= [ msb\_constant\_expression : lsb\_constant\_expression ]

associative\_dimension ::=  
 [ data\_type ]  
 | [ \* ]

variable\_dimension<sup>13</sup> ::=  
 { sized\_or\_unsized\_dimension }

LRM 17

| associative\_dimension  
 | queue\_dimension LRM 160

queue\_dimension ::= [ \$ [ : constant\_expression ] ]

unsized\_dimension<sup>12</sup> ::= [ ] LRM 17

sized\_or\_unsized\_dimension ::= unpacked\_dimension | unsized\_dimension

## A.2.6 Function declarations

function\_data\_type<sup>6</sup> ::= data\_type | void LRM 249

~~data\_type\_common\_item~~  
~~† void~~ LRM 45

function\_body\_declaration ::=

[ signing ] [ type\_or\_dimensions ]  
 [ interface\_identifier . | class\_scope ] function\_identifier ; LRM 249

{ tf\_item\_declaration }  
 { function\_statement\_or\_null }  
**endfunction** [ : function\_identifier ]

| [ signing ] [ type\_or\_dimensions ]  
 [ interface\_identifier . | class\_scope ] function\_identifier ( [ tf\_port\_list ] ); LRM 7

{ block\_item\_declaration }  
 { function\_statement\_or\_null }

**endfunction** [ : function\_identifier ]

function\_declaration ::=

**function** [ lifetime ] function\_body\_declaration

named\_function\_proto ::= [ signing ] function\_data\_type function\_identifier ( [ list\_of\_tf\_proto\_formals LRM 65

tf\_port\_list ] ) LRM 243

~~list\_of\_tf\_proto\_formals ::=~~  
~~{ attribute\_instance } tf\_proto\_formal { , { attribute\_instance } tf\_proto\_formal }~~ LRM 40  
LRM 65

type\_or\_dimensions ::=

packed\_dimension { packed\_dimension }  
 | function\_data\_type

dpi\_import\_export ::=

**import "DPI"** [ dpi\_function\_import\_property ] [ c\_identifier = ] dpi\_function\_proto ; LRM 132

| **import "DPI"** [ dpi\_task\_import\_property ] [ c\_identifier = ] dpi\_task\_proto ;

| **export "DPI"** [ c\_identifier = ] **function** function\_identifier ;

| **export "DPI"** [ c\_identifier = ] ~~task task~~ task\_identifier ; LRM 261

dpi\_function\_import\_property ::= **context** | **pure**

dpi\_task\_import\_property ::= **context**

dpi\_function\_proto<sup>9,10</sup> ::= **function** named\_function\_proto

dpi\_task\_proto<sup>10</sup> ::= **task** named\_task\_proto LRM 5

## A.2.7 Task declarations

task\_body\_declaration ::= LRM 17

[ interface\_identifier . | class\_scope ] task\_identifier ; LRM 249

{ tf\_item\_declaration }  
 { statement\_or\_null }  
**endtask** [ : task\_identifier ]  
LRM 40  
LRM 58  
LRM 96  
LRM 98

| [ interface\_identifier . | class\_scope ] task\_identifier ( [ tf\_port\_list ] ); LRM 7

{ block\_item\_declaration }  
 { statement\_or\_null }

**endtask** [ : task\_identifier ]

task\_declaration ::= **task** [ lifetime ] task\_body\_declaration

tf\_item\_declaration ::=

block\_item\_declaration

~~† { attribute\_instance } tf\_input\_declaration †~~

LRM 243

~~† { attribute\_instance } tf\_output\_declaration †~~

~~† { attribute\_instance } tf\_inout\_declaration †~~

~~† { attribute\_instance } tf\_ref\_declaration †~~

| tf\_port\_declaration

tf\_port\_list ::=

tf\_port\_item { , tf\_port\_item }

~~tf\_port\_item ::=~~

~~{ attribute\_instance } tf\_input\_declaration~~

LRM 40  
LRM 65

~~† { attribute\_instance } tf\_output\_declaration~~

~~† { attribute\_instance } tf\_inout\_declaration~~

~~† { attribute\_instance } tf\_ref\_declaration~~

~~† { attribute\_instance } { signing } { packed\_dimension } list\_of\_tf\_variable\_identifiers~~

LRM 7

~~† { attribute\_instance } data\_type list\_of\_tf\_variable\_identifiers~~

tf\_port\_item ::=

{ attribute\_instance }

[ tf\_port\_direction ] data\_type\_or\_implicit

port\_identifier variable\_dimension [ = expression ]

LRM 243

~~tf\_input\_declaration ::=~~

~~**input** [ signing ] { packed\_dimension } list\_of\_tf\_variable\_identifiers~~

LRM 45  
LRM 100

~~† **input** data\_type list\_of\_tf\_variable\_identifiers~~

~~tf\_output\_declaration ::=~~

~~**output** [ signing ] { packed\_dimension } list\_of\_tf\_variable\_identifiers~~

~~† **output** data\_type list\_of\_tf\_variable\_identifiers~~

~~tf\_inout\_declaration ::=~~

~~**inout** [ signing ] { packed\_dimension } list\_of\_tf\_variable\_identifiers~~

~~† **inout** data\_type list\_of\_tf\_variable\_identifiers~~

~~tf\_ref\_declaration ::=~~

~~{ **const** } **ref** data\_type list\_of\_tf\_variable\_identifiers~~

tf\_port\_direction ::= port\_direction | **const ref**

LRM 243

tf\_port\_declaration ::=

{ attribute\_instance } tf\_port\_direction data\_type\_or\_implicit list\_of\_tf\_variable\_identifiers ;

named\_task\_proto ::= task\_identifier ( [ list\_of\_tf\_proto\_formals tf\_port\_list ] )

LRM 40  
LRM 65

~~task\_proto\_formal tf\_proto\_formal ::=~~

~~tf\_input\_declaration~~

~~† tf\_output\_declaration~~

~~† tf\_inout\_declaration~~

~~† tf\_ref\_declaration~~

## A.2.8 Block item declarations

block\_item\_declaration ::=

{ attribute\_instance } data\_declaration

| { attribute\_instance } local\_parameter\_declaration

| { attribute\_instance } parameter\_declaration ;

| { attribute\_instance } overload\_declaration

LRM 35

overload\_declaration ::=

**bind** overload\_operator **function** data\_type function\_identifier ( overload\_proto\_formals ) ;

LRM 77

overload\_operator ::= + | ++ | - | -- | \* | \*\* | / | % | == | != | < | <= | > | >= | =  
overload\_proto\_formals ::= data\_type { , data\_type }

### A.2.9 Interface declarations

virtual\_interface\_declaration ::=

**virtual** [ **interface** ] interface\_identifier list\_of\_virtual\_interface\_decl ;

LRM 72

modport\_declaration ::= **modport** modport\_item { , modport\_item } ;

modport\_item ::= modport\_identifier ( modport\_ports\_declaration { , modport\_ports\_declaration } )

modport\_ports\_declaration ::=

{ attribute\_instance } modport\_simple\_ports\_declaration  
| { attribute\_instance } modport\_hierarchical\_ports\_declaration  
| { attribute\_instance } modport\_tf\_ports\_declaration  
| { attribute\_instance } modport\_clocking\_declaration

LRM 13

modport\_clocking\_declaration ::= **clocking** clocking\_identifier

~~modport\_simple\_ports\_declaration ::=~~

~~**input** list\_of\_modport\_port\_identifiers  
† **output** list\_of\_modport\_port\_identifiers  
† **inout** list\_of\_modport\_port\_identifiers  
† **ref** [ data\_type ] list\_of\_modport\_port\_identifiers~~

LRM 72

modport\_simple\_ports\_declaration ::=

port\_direction modport\_simple\_port { , modport\_simple\_port }

LRM 243

modport\_simple\_port ::=

port\_identifier  
| . port\_identifier ( [ expression ] )

modport\_hierarchical\_ports\_declaration ::=

interface\_instance\_identifier [ [ constant\_expression ] ] . modport\_identifier

modport\_tf\_ports\_declaration ::=

import\_export modport\_tf\_port

modport\_tf\_port ::=

**task** named\_task\_proto { , named\_task\_proto }  
| **function** named\_function\_proto { , named\_function\_proto }  
| tf\_identifier { , tf\_identifier }

LRM 173

import\_export ::= **import** | **export**

### A.2.10 Assertion declarations

concurrent\_assertion\_item ::= [ block\_identifier : ] concurrent\_assertion\_statement

~~econcurrent\_assert\_statement  
† econcurrent\_cover\_statement  
† econcurrent\_assertion\_item\_declaration~~

LRM 240

concurrent\_assertion\_statement ::=

assert\_property\_statement  
| assume\_property\_statement  
| cover\_property\_statement

~~econcurrent\_assert\_statement ::=~~

~~{ block\_identifiers } assert\_property\_statement~~

~~econcurrent\_cover\_statement ::=~~

~~{ block\_identifiers } cover\_property\_statement~~

assert\_property\_statement ::=

**assert property** ( property\_spec ) action\_block

LRM 131  
LRM 133  
LRM 136

assume\_property\_statement ::=

```

assume property (property_spec);
cover_property_statement ::=
 cover property (property_spec) statement_or_null
expect_property_statement ::=
 expect (property_spec) action_block
property_instance ::=
 ps_property_identifier [([actual_arg_list])]
concurrent_assertion_item_declaration ::=
 property_declaration
 | sequence_declaration
property_declaration ::=
 property property_identifier [property_formal_list ([list_of_formals])];
 { assertion_variable_declaration }
 property_spec ;
endproperty [: property_identifier]
property_formal_list ::=
 (formal_list_item { ; formal_list_item })
property_spec ::=
 [clocking_event] [disable iff (expression)] property_expr
 † disable iff (expression) † multi_clock_property_expr
property_expr ::=
 sequence_expr
 | (property_expr)
 | not property_expr
 | property_expr or property_expr
 | property_expr and property_expr
 | sequence_expr |-> property_expr
 | sequence_expr |=> property_expr
 | if (expression) property_expr [else property_expr]
 | property_instance
 | clocking_event property_expr
multi_clock_property_expr ::=
 property_expr
 † † multi_clock_sequence
 † clocking_event multi_clock_property_expr
 † (multi_clock_property_expr)
 † not multi_clock_property_expr
 † multi_clock_property_expr or multi_clock_property_expr
 † multi_clock_property_expr and multi_clock_property_expr
 † multi_clock_sequence |> multi_clock_property_expr
 † multi_clock_sequence |=> multi_clock_property_expr
 † if (expression) multi_clock_property_expr [else multi_clock_property_expr]
 † property_instance
 † clocking_event property_expr
sequence_declaration ::=
 sequence sequence_identifier [sequence_formal_list ([list_of_formals])];
 { assertion_variable_declaration }
 sequence_spec ;
 sequence_expr ;
endsequence [: sequence_identifier]
sequence_formal_list ::=

```

LRM 208  
LRM 249

LRM 208

LRM 131

LRM 278

LRM 278

LRM 262  
LRM 278

LRM 131

LRM 262

LRM 278

LRM 208

LRM 278

LRM 208

|                                                                                                         |         |
|---------------------------------------------------------------------------------------------------------|---------|
| <del>( formal_list_item { , formal_list_item } )</del>                                                  |         |
| sequence_spec ::=                                                                                       | LRM 278 |
| <del>multi_clock_sequence</del>                                                                         |         |
| <del>sequence_expr</del>                                                                                |         |
| multi_clock_sequence ::=                                                                                | LRM 278 |
| sequence_expr                                                                                           |         |
| <del>clocking_event multi_clock_sequence</del>                                                          | LRM 131 |
| <del>( multi_clock_sequence )</del>                                                                     |         |
| <del>multi_clock_sequence ## multi_clock_sequence</del>                                                 |         |
| <del>multi_clock_sequence cycle_delay_range multi_clock_sequence</del>                                  | LRM 211 |
| sequence_expr ::=                                                                                       |         |
| cycle_delay_range sequence_expr { cycle_delay_range sequence_expr }                                     |         |
| sequence_expr cycle_delay_range sequence_expr { cycle_delay_range sequence_expr }                       | LRM 129 |
| expression_or_dist [ boolean_abbrev ]                                                                   | LRM 133 |
| ( expression_or_dist { , sequence_match_item } ) [ boolean_abbrev ]                                     | LRM 100 |
| sequence_instance [ sequence_abbrev ]                                                                   | LRM 180 |
| ( sequence_expr { , sequence_match_item } ) [ sequence_abbrev ]                                         |         |
| sequence_expr <b>and</b> sequence_expr                                                                  |         |
| sequence_expr <b>intersect</b> sequence_expr                                                            |         |
| sequence_expr <b>or</b> sequence_expr                                                                   |         |
| <b>first_match</b> ( sequence_expr { , sequence_match_item } )                                          | LRM 208 |
| expression_or_dist <b>throughout</b> sequence_expr                                                      |         |
| sequence_expr <b>within</b> sequence_expr                                                               |         |
| <b>clocking_event</b> sequence_expr                                                                     | LRM 278 |
| cycle_delay_range ::=                                                                                   |         |
| <del>## constant_expression</del>                                                                       |         |
| ## integral_number                                                                                      | LRM 275 |
| ## identifier                                                                                           |         |
| ## ( constant_expression )                                                                              |         |
| ## [ cycle_delay_const_range_expression ]                                                               |         |
| sequence_method_call ::=                                                                                | LRM 275 |
| sequence_instance . method_identifier                                                                   |         |
| sequence_match_item ::=                                                                                 | LRM 180 |
| variable_assignment                                                                                     |         |
| subroutine_call                                                                                         |         |
| sequence_instance ::=                                                                                   |         |
| ps_sequence_identifier [ ( [ actual_arg_list ] ) ]                                                      | LRM 208 |
| formal_list_item ::=                                                                                    | LRM 249 |
| formal_identifier [ = actual_arg_expr ]                                                                 |         |
| list_of_formals ::= formal_list_item { , formal_list_item }                                             |         |
| actual_arg_list ::=                                                                                     |         |
| ( actual_arg_expr { , actual_arg_expr } )                                                               |         |
| ( <b>.</b> formal_identifier ( actual_arg_expr ) { , <b>.</b> formal_identifier ( actual_arg_expr ) } ) |         |
| actual_arg_expr ::=                                                                                     |         |
| event_expression                                                                                        |         |
| \$                                                                                                      | LRM 133 |
| boolean_abbrev ::=                                                                                      |         |
| consecutive_repetition                                                                                  |         |
| non_consecutive_repetition                                                                              |         |
| goto_repetition                                                                                         |         |

sequence\_abbrev ::= consecutive\_repetition  
 consecutive\_repetition ::= [\* const\_or\_range\_expression ]  
 non\_consecutive\_repetition ::= [\*= [= const\_or\_range\_expression ]  
 goto\_repetition ::= [\*-> [-> const\_or\_range\_expression ]

LRM 209

const\_or\_range\_expression ::=  
     constant\_expression  
     | cycle\_delay\_const\_range\_expression  
 cycle\_delay\_const\_range\_expression ::=  
     constant\_expression : constant\_expression  
     | constant\_expression : \$

~~expression\_or\_dist ::=  
     expression  
     † expression dist { dist\_list }~~

LRM 208

LRM 133

expression\_or\_dist ::= expression [ dist { dist\_list } ]

LRM 208

assertion\_variable\_declaration ::=  
     data\_type list\_of\_variable\_identifiers ;

### A.2.11 Covergroup declarations

LRM 61  
LRM 65

covergroup\_declaration ::=  
     **covergroup** covergroup\_identifier [ ( ~~list\_of\_tf\_proto\_formals~~ [ tf\_port\_list ] ) ] [ coverage\_event ] ;  
         { coverage\_spec\_or\_option ; }  
     **endgroup** [ : covergroup\_identifier ]

LRM 127

LRM 229  
LRM 243

coverage\_spec\_or\_option ::=  
     { attribute\_instance } coverage\_spec  
     | { attribute\_instance } coverage\_option ;

coverage\_option ::=  
     **option**.member\_identifier = expression  
     | **type\_option**.member\_identifier = expression

coverage\_spec ::=  
     cover\_point  
     | cover\_cross

coverage\_event ::=  
     clocking\_identifier  
     | @@ ( block\_event\_expression )

LRM 127

block\_event\_expression ::=  
     block\_event\_expression **or** block\_event\_expression  
     | **begin** hierarchical\_btf\_identifier  
     | **end** hierarchical\_btf\_identifier

hierarchical\_btf\_identifier ::=  
     hierarchical\_tf\_identifier  
     | hierarchical\_block\_identifier  
     | hierarchical\_identifier † [ class\_scope \*\* ] † method\_identifier

LRM 173

LRM 249

cover\_point ::= [ cover\_point\_identifier : ] **coverpoint** expression [ **iff** ( expression ) ] bins\_or\_empty

bins\_or\_empty ::=  
     { { attribute\_instance } { bins\_or\_options ; } }  
     | ;

bins\_or\_options ::=  
     coverage\_option  
     | [ **wildcard** ] bins\_keyword bin\_identifier [ [ [ expression ] ] ] = { range\_list } [ **iff** ( expression ) ]  
     | [ **wildcard** ] bins\_keyword bin\_identifier [ [ ] ] = † trans\_list † [ **iff** ( expression ) ]

```

 | bins_keyword bin_identifier [[[expression]]] = default [iff (expression)]
 | bins_keyword bin_identifier = default sequence [iff (expression)]

```

LRM 251  
LRM 256

```
bins_keyword ::= bins | illegal_bins | ignore_bins
```

```
range_list ::= value_range { , value_range }
```

```
trans_list ::= (trans_set) { , (trans_set) }
```

LRM 251

```
trans_set ::= trans_range_list => trans_range_list { => trans_range_list }
```

```
trans_range_list ::=
```

```

 trans_item
 | trans_item [[* repeat_range]]
 | trans_item [[*-> [-> repeat_range]]]
 | trans_item [[*= [= repeat_range]]]

```

LRM 267

```
trans_item ::= { range_list } ++ value_range
```

LRM 251  
LRM 253

```
repeat_range ::=
```

```

 expression
 | expression : expression

```

```
cover_cross ::= [cover_point_identifier :] cross cross list_of_coverpoints [iff (expression)]
 select_bins_or_empty
```

LRM 255

```
list_of_coverpoints ::= cross_item , cross_item { , cross_item }
```

```
cross_item ::=
```

```

 cover_point_identifier
 | variable_identifier

```

```
select_bins_or_empty ::=
```

```

 { { bins_selections_or_option ; } }
 | ;

```

```
bins_selection_or_option ::=
```

```

 { attribute_instance } coverage_option
 | { attribute_instance } bins_selection

```

```
bins_selection ::= bins_keyword bin_identifier = select_expression [iff (expression)]
```

LRM 255

```
select_expression ::=
```

```

 select_condition
 | ! select_condition
 | select_expression && select_expression
 | select_expression || select_expression
 | (select_expression)

```

```
select_condition ::= binsof (bins_expression) [intersect open_range_list]
```

```
bins_expression ::=
```

```

 variable_identifier
 | cover_point_identifier [. bins_identifier]

```

```
open_range_list ::= { open_value_range { , open_value_range } }
```

```
open_value_range ::= value_range22
```

LRM 160

## A.3 Primitive instances

### A.3.1 Primitive instantiation and instances

```
gate_instantiation ::=
```

```

 cmos_switchtype [delay3] cmos_switch_instance { , cmos_switch_instance } ;
 | enable_gatetype [drive_strength] [delay3] enable_gate_instance { , enable_gate_instance } ;
 | mos_switchtype [delay3] mos_switch_instance { , mos_switch_instance } ;
 | n_input_gatetype [drive_strength] [delay2] n_input_gate_instance { , n_input_gate_instance } ;

```



```

 | n_output_gatetype [drive_strength] [delay2] n_output_gate_instance
 { , n_output_gate_instance } ;
 | pass_en_swichtype [delay2] pass_enable_switch_instance { , pass_enable_switch_instance } ;
 | pass_swichtype pass_switch_instance { , pass_switch_instance } ;
 | pulldown [pulldown_strength] pull_gate_instance { , pull_gate_instance } ;
 | pullup [pullup_strength] pull_gate_instance { , pull_gate_instance } ;

```

```

cmos_switch_instance ::= [name_of_instance] (output_terminal , input_terminal ,
 ncontrol_terminal , pcontrol_terminal)

```

LRM 172

```

enable_gate_instance ::= [name_of_instance] (output_terminal , input_terminal , enable_terminal)
mos_switch_instance ::= [name_of_instance] (output_terminal , input_terminal , enable_terminal)
n_input_gate_instance ::= [name_of_instance] (output_terminal , input_terminal { , input_terminal })
n_output_gate_instance ::= [name_of_instance] (output_terminal { , output_terminal } ,
 input_terminal)
pass_switch_instance ::= [name_of_instance] (inout_terminal , inout_terminal)
pass_enable_switch_instance ::= [name_of_instance] (inout_terminal , inout_terminal ,
 enable_terminal)
pull_gate_instance ::= [name_of_instance] (output_terminal)

```

LRM 45

### A.3.2 Primitive strengths

```

pulldown_strength ::=
 (strength0 , strength1)
 | (strength1 , strength0)
 | (strength0)
pullup_strength ::=
 (strength0 , strength1)
 | (strength1 , strength0)
 | (strength1)

```

### A.3.3 Primitive terminals

```

enable_terminal ::= expression
inout_terminal ::= net_lvalue
input_terminal ::= expression
ncontrol_terminal ::= expression
output_terminal ::= net_lvalue
pcontrol_terminal ::= expression

```

### A.3.4 Primitive gate and switch types

```

cmos_swichtype ::= cmos | rcmos
enable_gatetype ::= bufif0 | bufif1 | notif0 | notif1
mos_swichtype ::= nmos | pmos | rnmos | rpmos
n_input_gatetype ::= and | nand | or | nor | xor | xnor
n_output_gatetype ::= buf | not
pass_en_swichtype ::= tranif0 | tranif1 | rtranif1 | rtranif0
pass_swichtype ::= tran | rtran

```

## A.4 Module, interface and generated instantiation

### A.4.1 Instantiation

#### A.4.1.1 Module instantiation

```

module_instantiation ::=
 module_identifier [parameter_value_assignment] hierarchical_instance { , hierarchical_instance } ;
parameter_value_assignment ::= # (list_of_parameter_assignments)
list_of_parameter_assignments ::=
 ordered_parameter_assignment { , ordered_parameter_assignment }
 | named_parameter_assignment { , named_parameter_assignment }
ordered_parameter_assignment ::= param_expression
named_parameter_assignment ::= . parameter_identifier ([param_expression])
hierarchical_instance ::= name_of_instance ([list_of_port_connections])
name_of_instance ::= instance_identifier { unpacked_dimension }
list_of_port_connections18 ::=
 ordered_port_connection { , ordered_port_connection }
 | named_port_connection { , named_port_connection }
ordered_port_connection ::= { attribute_instance } [expression]
named_port_connection ::=
 { attribute_instance } . port_identifier (([expression]))
 | { attribute_instance } .*

```

LRM 172

LRM 39

LRM 172

LRM 45

LRM 93

#### A.4.1.2 Interface instantiation

```

interface_instantiation ::=
 interface_identifier [parameter_value_assignment] hierarchical_instance { , hierarchical_instance }
 ;

```

LRM 172

#### A.4.1.3 Program instantiation

```

program_instantiation ::=
 program_identifier [parameter_value_assignment] hierarchical_instance { , hierarchical_instance }
 ;

```

LRM 45

LRM 172

### A.4.2 Generated instantiation

#### A.4.2.1 Generated module instantiation

```

generated_module_instantiation ::= generate { generate_module_item } endgenerate
generate_module_item ::=
 generate_module_conditional_statement
 | generate_module_case_statement
 | generate_module_loop_statement
 | [generate_block_identifier :] generate_module_block
 | module_or_generate_item
generate_module_conditional_statement ::=
 if (constant_expression) generate_module_item [else generate_module_item]
generate_module_case_statement ::=
 case (constant_expression) genvar_module_case_item { genvar_module_case_item } endcase
genvar_module_case_item ::=
 constant_expression { , constant_expression } : generate_module_item
 | default [:] generate_module_item
generate_module_loop_statement ::=
 for (genvar_decl_assignment ; constant_expression ; genvar_assignment)
 generate_module_named_block
genvar_assignment ::=
 genvar_identifier assignment_operator constant_expression

```

```

 | inc_or_dec_operator genvar_identifier
 | genvar_identifier inc_or_dec_operator
genvar_decl_assignment ::=
 [genvar] genvar_identifier = constant_expression
generate_module_named_block ::=
 begin : generate_block_identifier { generate_module_item } end [: generate_block_identifier]
 | generate_block_identifier : generate_module_block
generate_module_block ::=
 begin [: generate_block_identifier] { generate_module_item } end [: generate_block_identifier]

```

#### A.4.2.2 Generated interface instantiation

```

generated_interface_instantiation ::= generate { generate_interface_item } endgenerate
generate_interface_item ::=
 generate_interface_conditional_statement
 | generate_interface_case_statement
 | generate_interface_loop_statement
 | [generate_block_identifier :] generate_interface_block
 | interface_or_generate_item
generate_interface_conditional_statement ::=
 if (constant_expression) generate_interface_item [else generate_interface_item]
generate_interface_case_statement ::=
 case (constant_expression) genvar_interface_case_item { genvar_interface_case_item } endcase
genvar_interface_case_item ::=
 constant_expression { , constant_expression } : generate_interface_item
 | default [:] generate_interface_item
generate_interface_loop_statement ::=
 for (genvar_decl_assignment ; constant_expression ; genvar_assignment)
 generate_interface_named_block
generate_interface_named_block ::=
 begin : generate_block_identifier { generate_interface_item } end [: generate_block_identifier]
 | generate_block_identifier : generate_interface_block
generate_interface_block ::=
 begin [: generate_block_identifier]
 { generate_interface_item }
 end [: generate_block_identifier]

```

### A.5 UDP declaration and instantiation

#### A.5.1 UDP declaration

```

udp_nonansi_declaration ::=
 { attribute_instance } primitive udp_identifier (udp_port_list) ;
udp_ansi_declaration ::=
 { attribute_instance } primitive udp_identifier (udp_declaration_port_list) ;
udp_declaration ::=
 udp_nonansi_declaration udp_port_declaration { udp_port_declaration }
 udp_body
 endprimitive [: udp_identifier]
 | udp_ansi_declaration
 udp_body
 endprimitive [: udp_identifier]
 | extern udp_nonansi_declaration

```

LRM 242

```

| extern udp_ansi_declaration
| { attribute_instance } primitive udp_identifier (.*);
 { udp_port_declaration }
 udp_body
endprimitive [: udp_identifier]

```

```

udp_declaration ::=
 { attribute_instance } primitive udp_identifier (udp_port_list);
 udp_port_declaration { udp_port_declaration }
 udp_body
endprimitive
+ { attribute_instance } primitive udp_identifier (udp_declaration_port_list);
 udp_body
endprimitive

```

### A.5.2 UDP ports

```

udp_port_list ::= output_port_identifier , input_port_identifier { , input_port_identifier }
udp_declaration_port_list ::= udp_output_declaration , udp_input_declaration { , udp_input_declaration }
udp_port_declaration ::=
 udp_output_declaration ;
 | udp_input_declaration ;
 | udp_reg_declaration ;
udp_output_declaration ::=
 { attribute_instance } output port_identifier
 | { attribute_instance } output reg port_identifier [= constant_expression]
udp_input_declaration ::= { attribute_instance } input list_of_udp_port_identifiers
udp_reg_declaration ::= { attribute_instance } reg variable_identifier

```

### A.5.3 UDP body

```

udp_body ::= combinational_body | sequential_body
combinational_body ::= table combinational_entry { combinational_entry } endtable
combinational_entry ::= level_input_list : output_symbol ;
sequential_body ::= [udp_initial_statement] table sequential_entry { sequential_entry } endtable
udp_initial_statement ::= initial output_port_identifier = init_val ;
init_val ::= 1'b0 | 1'b1 | 1'bx | 1'bX | 1'B0 | 1'B1 | 1'Bx | 1'BX | 1 | 0
sequential_entry ::= seq_input_list : current_state : next_state ;
seq_input_list ::= level_input_list | edge_input_list
level_input_list ::= level_symbol { level_symbol }
edge_input_list ::= { level_symbol } edge_indicator { level_symbol }
edge_indicator ::= (level_symbol level_symbol) | edge_symbol
current_state ::= level_symbol
next_state ::= output_symbol | -
output_symbol ::= 0 | 1 | x | X
level_symbol ::= 0 | 1 | x | X | ? | b | B
edge_symbol ::= r | R | f | F | p | P | n | N | *

```

### A.5.4 UDP instantiation

```

udp_instantiation ::= udp_identifier [drive_strength] [delay2] udp_instance { , udp_instance } ;
udp_instance ::= [name_of_instance] (output_terminal , input_terminal { , input_terminal })

```

LRM 172

LRM 45

## A.6 Behavioral statements

### A.6.1 Continuous assignment and net alias statements

```
continuous_assign ::=
 assign [drive_strength] [delay3] list_of_net_assignments ;
 | assign [delay_control] list_of_variable_assignments ;
list_of_net_assignments ::= net_assignment { , net_assignment }
list_of_variable_assignments ::= variable_assignment { , variable_assignment }
net_alias ::= alias net_lvalue = net_lvalue { = net_lvalue } ;
net_assignment ::= net_lvalue = expression
```

LRM 100

### A.6.2 Procedural blocks and assignments

```
initial_construct ::= initial statement_or_null
always_construct ::= always always_keyword statement
always_keyword ::= always | always_comb | always_latch | always_ff
combinational_construct ::= always_comb statement
latch_construct ::= always_latch statement
ff_construct ::= always_ff statement
final_construct ::= final function_statement
blocking_assignment ::=
 variable_lvalue = delay_or_event_control expression
 | hierarchical_dynamic_array_variable_identifier [=] dynamic_array_new
 | class_variable_identifier = class_new
 | class_variable_identifier . randomize [()] with constraint_block
 | operator_assignment
operator_assignment ::= variable_lvalue assignment_operator expression
assignment_operator ::=
 = | += | -= | *= | /= | %= | &= | |= | ^= | <<= | >>= | <<<= | >>>=
nonblocking_assignment ::= variable_lvalue <= [delay_or_event_control] expression
procedural_continuous_assignments procedural_continuous_assignment ::=
 assign variable_assignment
 | deassign variable_lvalue
 | force variable_assignment
 | force net_assignment
 | release variable_lvalue
 | release net_lvalue
variable_assignment ::= variable_lvalue = expression
```

LRM 242

LRM 117

LRM 100

LRM 248

LRM 242

LRM 18

LRM 100

### A.6.3 Parallel and sequential blocks

```
action_block ::=
 statement_or_null
 | [statement] else statement_or_null
seq_block ::=
 begin [: block_identifier] { block_item_declaration } { statement_or_null }
 end [: block_identifier]
par_block ::=
 fork [: block_identifier] { block_item_declaration } { statement_or_null }
 join_keyword [: block_identifier]
join_keyword ::= join | join_any | join_none
```

LRM 39

### A.6.4 Statements

statement\_or\_null ::=  
    statement

    | { attribute\_instance } ;

LRM 66

statement ::= [ block\_identifier : ] { attribute\_instance } statement\_item

statement\_item ::=

    blocking\_assignment ;

    | nonblocking\_assignment ;

    | ~~procedural\_continuous\_assignments ;~~

    | procedural\_continuous\_assignment ;

    | case\_statement

    | conditional\_statement

    | inc\_or\_dec\_expression ;

    | subroutine\_call\_statement

    | disable\_statement

    | event\_trigger

    | loop\_statement

    | jump\_statement

    | par\_block

    | procedural\_timing\_control\_statement

    | seq\_block

    | wait\_statement

    | ~~procedural\_assertion\_item~~

    | procedural\_assertion\_statement

    | clocking\_drive ;

    | randsequence\_statement

    | ~~scope\_randomize~~

    | randcase\_statement

    | expect\_property\_statement

LRM 39

LRM 41

LRM 62

LRM 63

LRM 66

LRM 73

LRM 113

LRM 136

LRM 173

LRM 240

LRM 242

LRM 248

LRM 250

function\_statement ::= statement

function\_statement\_or\_null ::=

    function\_statement

    | { attribute\_instance } ;

LRM 18

~~scope\_randomize ::= [ std :: ] randomize ( [ variable\_identifier\_list ] ) [ with { constraint\_block } ]~~

variable\_identifier\_list ::= variable\_identifier { , variable\_identifier }

LRM 115

LRM 248

LRM 165

### A.6.5 Timing control statements

procedural\_timing\_control\_statement ::=

    procedural\_timing\_control\_statement\_or\_null

delay\_or\_event\_control ::=

    delay\_control

    | event\_control

    | **repeat** ( expression ) event\_control

delay\_control ::=

    # delay\_value

    | # ( mintypmax\_expression )

event\_control ::=

    @ hierarchical\_event\_identifier

    | @ ( event\_expression )

    | @\*

    | @ ( \* )

LRM 18

| @ sequence\_instance LRM 73

event\_expression ::=  
 [ edge\_identifier ] expression [ **iff** expression ]  
 | sequence\_instance [ **iff** expression ]  
 | event\_expression **or** event\_expression  
 | event\_expression , event\_expression LRM 73

procedural\_timing\_control ::=  
 delay\_control  
 | event\_control  
 | cycle\_delay LRM 139

jump\_statement ::=  
**return** [ expression ] ;  
 | **break** ;  
 | **continue** ;

wait\_statement ::=  
**wait** ( expression ) statement\_or\_null  
 | **wait fork** ;  
 | **wait\_order** ( hierarchical\_identifier [ , hierarchical\_identifier ] ) action\_block

event\_trigger ::=  
 -> hierarchical\_event\_identifier ;  
 |->> [ delay\_or\_event\_control ] hierarchical\_event\_identifier ;

disable\_statement ::=  
**disable** hierarchical\_task\_identifier ;  
 | **disable** hierarchical\_block\_identifier ;  
 | **disable fork** ;

### A.6.6 Conditional statements

conditional\_statement ::= LRM 81

**if** ( cond\_predicate ) statement\_or\_null [ **else** statement\_or\_null ]  
 | unique\_priority\_if\_statement LRM 122

unique\_priority\_if\_statement ::=  
 [ unique\_priority ] **if** ( cond\_predicate ) statement\_or\_null  
 { **else if** ( cond\_predicate ) statement\_or\_null }  
 [ **else** statement\_or\_null ] LRM 39

unique\_priority ::= **unique** | **priority**

cond\_predicate ::= LRM 122  
 expression\_or\_cond\_pattern { **&&** expression\_or\_cond\_pattern }

expression\_or\_cond\_pattern ::=  
 expression | cond\_pattern

cond\_pattern ::= expression **matches** pattern

### A.6.7 Case statements

case\_statement ::= LRM 122  
 [ unique\_priority ] case\_keyword ( expression ) case\_item { case\_item } **endcase**  
 | [ unique\_priority ] case\_keyword ( expression ) **matches** case\_pattern\_item { case\_pattern\_item }  
**endcase**

case\_keyword ::= **case** | **casez** | **casex**

case\_item ::=  
 expression { , expression } : statement\_or\_null  
 | **default** [ : ] statement\_or\_null

case\_pattern\_item ::=

pattern [ **&&** expression ] : statement\_or\_null  
| **default** [ : ] statement\_or\_null

LRM 39

randcase\_statement ::=

**randcase** randcase\_item { randcase\_item } **endcase**

LRM 66

randcase\_item ::= expression : statement\_or\_null

### A.6.7.1 Patterns

LRM 122

pattern ::=

variable\_identifier

| **.\***

| **.** constant\_expression

| **tagged** member\_identifier [ pattern ]

| { pattern { , pattern } }

| { member\_identifier : pattern { , member\_identifier : pattern } }

LRM 149  
LRM 150

### A.6.8 Looping statements

LRM 39

loop\_statement ::=

**forever** statement\_or\_null

| **repeat** ( expression ) statement\_or\_null

| **while** ( expression ) statement\_or\_null

| **for** ( for\_initialization ; expression ; for\_step )  
statement\_or\_null

| **do** statement\_or\_null **while** ( expression ) ;

| **foreach** ( array\_identifier { [ loop\_variables ] } ) statement

LRM 27

LRM 100

LRM 248

for\_initialization ::=

list\_of\_variable\_assignments

| data\_type list\_of\_variable\_assignments { , data\_type list\_of\_variable\_assignments }

for\_step ::= for\_step\_assignment { , for\_step\_assignment }

for\_step\_assignment ::=

operator\_assignment

| inc\_or\_dec\_expression

LRM 35

LRM 248

loop\_variables ::= [ index\_variable\_identifier ] { , [ index\_variable\_identifier ] }

LRM 100

### A.6.9 Subroutine call statements

subroutine\_call\_statement ::=

**subroutine\_call** ;

| **void** ' ( function\_subroutine\_call ) ;

LRM 173

LRM 113

LRM 173

### A.6.10 Assertion statements

~~procedural\_assertion\_item ::=~~

~~assert\_property\_statement~~

~~† eover\_property\_statement~~

~~† immediate\_assert\_statement~~

~~† assume\_property\_statement~~

LRM 133

procedural\_assertion\_statement ::=

concurrent\_assertion\_statement

| immediate\_assert\_statement

LRM 240

immediate\_assert\_statement ::=

**assert** ( expression ) action\_block

LRM 137

### A.6.11 Clocking block

clocking\_declaration ::= [ **default** ] **clocking** [ clocking\_identifier ] clocking\_event ;  
{ clocking\_item }

LRM 270



```

endclocking [: clocking_identifier]
clocking_event ::=
 @ identifier
 | @ (event_expression)
clocking_item ::=
 default default_skew ;
 | clocking_direction list_of_clocking_decl_assign ;
 | { attribute_instance } concurrent_assertion_item_declaration
default_skew ::=
 input clocking_skew
 | output clocking_skew
 | input clocking_skew output clocking_skew
clocking_direction ::=
 input [clocking_skew]
 | output [clocking_skew]
 | input [clocking_skew] output [clocking_skew]
 | inout
list_of_clocking_decl_assign ::= clocking_decl_assign { , clocking_decl_assign }
clocking_decl_assign ::= signal_identifier [= hierarchical_identifier]
clocking_skew ::=
 edge_identifier [delay_control]
 | delay_control
clocking_drive ::=
 clockvar_expression <= [cycle_delay] expression
 | cycle_delay clockvar_expression <= expression
cycle_delay ::= ## expression
 ## integral_number
 | ## identifier
 | ## (expression)
clockvar ::= clocking_identifier . identifier
clockvar_expression ::=
 clockvar range
 | clockvar [range_expression]

```

LRM 271

### A.6.12 Randsequence

```

randsequence_statement ::= randsequence ([production_identifier])
 production { production }
 endsequence
production ::= [function_data_type] production_name [(tf_port_list)] : rs_rule { | rs_rule } ;
rs_rule ::= rs_production_list [:= expression [rs_code_block]]
rs_production_list ::=
 rs_prod { rs_prod }
 | rand join [(expression)] production_item production_item { production_item }
rs_code_block ::= { { data_declaration } { statement_or_null } }
rs_prod ::=
 production_item
 | rs_code_block
 | rs_if_else
 | rs_repeat
 | rs_case

```

LRM 62

LRM 165

```

production_item ::= production_identifier [(list_of_arguments)]
rs_if_else ::= if (expression) production_item [else production_item]
rs_repeat ::= repeat (expression) production_item
rs_case ::= case (expression) rs_case_item { rs_case_item } endcase
rs_case_item ::=
 expression { , expression } : production_item
 | default [:] production_item

```

## A.7 Specify section

### A.7.1 Specify block declaration

```

specify_block ::= specify { specify_item } endspecify

```

```

specify_item ::=
 specparam_declaration
 | pulsestyle_declaration
 | showcanceled_declaration
 | path_declaration
 | system_timing_check

pulsestyle_declaration ::=
 pulsestyle_oneevent list_of_path_outputs ;
 | pulsestyle_ondetect list_of_path_outputs ;

 showcanceled_declaration ::=
 showcancelled list_of_path_outputs ;
 | nshowcancelled list_of_path_outputs ;

```

### A.7.2 Specify path declarations

```

path_declaration ::=
 simple_path_declaration ;
 | edge_sensitive_path_declaration ;
 | state_dependent_path_declaration ;

simple_path_declaration ::=
 parallel_path_description = path_delay_value
 | full_path_description = path_delay_value

parallel_path_description ::=
 (specify_input_terminal_descriptor [polarity_operator] => specify_output_terminal_descriptor)

full_path_description ::=
 (list_of_path_inputs [polarity_operator] *> list_of_path_outputs)

list_of_path_inputs ::=
 specify_input_terminal_descriptor { , specify_input_terminal_descriptor }

list_of_path_outputs ::=
 specify_output_terminal_descriptor { , specify_output_terminal_descriptor }

```

### A.7.3 Specify block terminals

```

specify_input_terminal_descriptor ::=
 input_identifier [[constant_range_expression]]

specify_output_terminal_descriptor ::=
 output_identifier [[constant_range_expression]]

input_identifier ::= input_port_identifier | inout_port_identifier | interface_identifier.port_identifier
output_identifier ::= output_port_identifier | inout_port_identifier | interface_identifier.port_identifier

```

LRM 6

### A.7.4 Specify path delays

```

path_delay_value ::=
 list_of_path_delay_expressions
 | (list_of_path_delay_expressions)
list_of_path_delay_expressions ::=
 t_path_delay_expression
 | trise_path_delay_expression , tfall_path_delay_expression
 | trise_path_delay_expression , tfall_path_delay_expression , tz_path_delay_expression
 | t01_path_delay_expression , t10_path_delay_expression , t0z_path_delay_expression ,
 tz1_path_delay_expression , t1z_path_delay_expression , tz0_path_delay_expression
 | t01_path_delay_expression , t10_path_delay_expression , t0z_path_delay_expression ,
 tz1_path_delay_expression , t1z_path_delay_expression , tz0_path_delay_expression ,
 t0x_path_delay_expression , tx1_path_delay_expression , t1x_path_delay_expression ,
 tx0_path_delay_expression , txz_path_delay_expression , tzx_path_delay_expression
t_path_delay_expression ::= path_delay_expression
trise_path_delay_expression ::= path_delay_expression
tfall_path_delay_expression ::= path_delay_expression
tz_path_delay_expression ::= path_delay_expression
t01_path_delay_expression ::= path_delay_expression
t10_path_delay_expression ::= path_delay_expression
t0z_path_delay_expression ::= path_delay_expression
tz1_path_delay_expression ::= path_delay_expression
t1z_path_delay_expression ::= path_delay_expression
tz0_path_delay_expression ::= path_delay_expression
t0x_path_delay_expression ::= path_delay_expression
tx1_path_delay_expression ::= path_delay_expression
t1x_path_delay_expression ::= path_delay_expression
tx0_path_delay_expression ::= path_delay_expression
txz_path_delay_expression ::= path_delay_expression
tzx_path_delay_expression ::= path_delay_expression
path_delay_expression ::= constant_mintypmax_expression
edge_sensitive_path_declaration ::=
 parallel_edge_sensitive_path_description = path_delay_value
 | full_edge_sensitive_path_description = path_delay_value
parallel_edge_sensitive_path_description ::=
 ([edge_identifier] specify_input_terminal_descriptor =>
 (specify_output_terminal_descriptor [polarity_operator] : data_source_expression))
full_edge_sensitive_path_description ::=
 ([edge_identifier] list_of_path_inputs *>
 (list_of_path_outputs [polarity_operator] : data_source_expression))
data_source_expression ::= expression
edge_identifier ::= posedge | negedge
state_dependent_path_declaration ::=
 if (module_path_expression) simple_path_declaration
 | if (module_path_expression) edge_sensitive_path_declaration
 | ifnone simple_path_declaration
polarity_operator ::= + | -

```

LRM 18

LRM 18

## A.7.5 System timing checks

**A.7.5.1 System timing check commands**

```

system_timing_check ::=
 $setup_timing_check
 | $hold_timing_check
 | $setuphold_timing_check
 | $recovery_timing_check
 | $removal_timing_check
 | $recrem_timing_check
 | $skew_timing_check
 | $timeskew_timing_check
 | $fullskew_timing_check
 | $period_timing_check
 | $width_timing_check
 | $nochange_timing_check

$setup_timing_check ::=
 $setup (data_event , reference_event , timing_check_limit [, [notify_reg]]);

$hold_timing_check ::=
 $hold (reference_event , data_event , timing_check_limit [, [notify_reg]]);

$setuphold_timing_check ::=
 $setuphold (reference_event , data_event , timing_check_limit , timing_check_limit
 [, [notify_reg] [, [stamptime_condition] [, [checktime_condition]
 [, [delayed_reference] [, [delayed_data]]]]]]);

$recovery_timing_check ::=
 $recovery (reference_event , data_event , timing_check_limit [, [notify_reg]]);

$removal_timing_check ::=
 $removal (reference_event , data_event , timing_check_limit [, [notify_reg]]);

$recrem_timing_check ::=
 $recrem (reference_event , data_event , timing_check_limit , timing_check_limit
 [, [notify_reg] [, [stamptime_condition] [, [checktime_condition]
 [, [delayed_reference] [, [delayed_data]]]]]]);

$skew_timing_check ::=
 $skew (reference_event , data_event , timing_check_limit [, [notify_reg]]);

$timeskew_timing_check ::=
 $timeskew (reference_event , data_event , timing_check_limit
 [, [notify_reg] [, [event_based_flag] [, [remain_active_flag]]]]);

$fullskew_timing_check ::=
 $fullskew (reference_event , data_event , timing_check_limit , timing_check_limit
 [, [notify_reg] [, [event_based_flag] [, [remain_active_flag]]]]);

$period_timing_check ::=
 $period (controlled_reference_event , timing_check_limit [, [notify_reg]]);

$width_timing_check ::=
 $width (controlled_reference_event , timing_check_limit , threshold [, [notify_reg]]);

$nochange_timing_check ::=
 $nochange (reference_event , data_event , start_edge_offset ,
 end_edge_offset [, [notify_reg]]);

```

**A.7.5.2 System timing check command arguments**

```

checktime_condition ::= mintypmax_expression
controlled_reference_event ::= controlled_timing_check_event
data_event ::= timing_check_event

```

```

delayed_data ::=
 terminal_identifier
 | terminal_identifier [constant_mintypmax_expression]
delayed_reference ::=
 terminal_identifier
 | terminal_identifier [constant_mintypmax_expression]
end_edge_offset ::= mintypmax_expression
event_based_flag ::= constant_expression
notify_reg ::= variable_identifier
reference_event ::= timing_check_event
remain_active_flag ::= constant_mintypmax_expression
stamp_time_condition ::= mintypmax_expression
start_edge_offset ::= mintypmax_expression
threshold ::= constant_expression
timing_check_limit ::= expression

```

### A.7.5.3 System timing check event definitions

```

timing_check_event ::=
 [timing_check_event_control] specify_terminal_descriptor [&&& timing_check_condition]
controlled_timing_check_event ::=
 timing_check_event_control specify_terminal_descriptor [&&& timing_check_condition]
timing_check_event_control ::=
 posedge
 | negedge
 | edge_control_specifier
specify_terminal_descriptor ::=
 specify_input_terminal_descriptor
 | specify_output_terminal_descriptor
edge_control_specifier ::= edge [edge_descriptor { , edge_descriptor }]
edge_descriptor1 ::= 01 | 10 | z_or_x zero_or_one | zero_or_one z_or_x
zero_or_one ::= 0 | 1
z_or_x ::= x | X | z | Z
timing_check_condition ::=
 scalar_timing_check_condition
 | (scalar_timing_check_condition)
scalar_timing_check_condition ::=
 expression
 | ~ expression
 | expression == scalar_constant
 | expression === scalar_constant
 | expression != scalar_constant
 | expression !== scalar_constant
scalar_constant ::= 1'b0 | 1'b1 | 1'B0 | 1'B1 | 'b0 | 'b1 | 'B0 | 'B1 | 1 | 0

```

## A.8 Expressions

### A.8.1 Concatenations

```

concatenation ::=
 { expression { , expression } }

```

```

 | { struct_member_label : expression { , struct_member_label : expression } }
 | { array_member_label : expression { , array_member_label : expression } }

```

LRM 42

constant\_concatenation ::=

```

 { constant_expression { , constant_expression } }
 | { struct_member_label : constant_expression { , struct_member_label : constant_expression } }
 | { array_member_label : constant_expression { , array_member_label : constant_expression } }

```

struct\_member\_label ::=

```

default
 | type_identifier
 | variable_identifier

```

array\_member\_label ::=

```

default
 | type_identifier
 | constant_expression

```

constant\_multiple\_concatenation ::= { constant\_expression constant\_concatenation }

module\_path\_concatenation ::= { module\_path\_expression { , module\_path\_expression } }

module\_path\_multiple\_concatenation ::= { constant\_expression module\_path\_concatenation }

multiple\_concatenation ::= { expression concatenation }<sup>20</sup>

LRM 22

streaming\_expression ::= { stream\_operator [ slice\_size ] stream\_concatenation }

LRM 109

stream\_operator ::= >> | <<

slice\_size ::= ps\_type\_identifier | constant\_expression

LRM 249

stream\_concatenation ::= { stream\_expression { , stream\_expression } }

stream\_expression ::=

```

 expression
 | array_identifier [with [array_range_expression]]

```

array\_range\_expression ::=

```

 expression
 | expression : expression
 | expression +: expression
 | expression -: expression

```

empty\_queue<sup>23</sup> ::= { }

LRM 160

## A.8.2 Subroutine calls

LRM 173

constant\_function\_call ::= function\_subroutine\_call<sup>26</sup>

tf\_call ::= ps\_or\_hierarchical\_tf\_identifier { attribute\_instance } [ ( list\_of\_arguments ) ]

LRM 249

system\_tf\_call ::= system\_tf\_identifier [ ( list\_of\_arguments ) ]

subroutine\_call ::=

```

 tf_call
 | system_tf_call
 | method_call
 | randomize_call

```

LRM 248

function\_subroutine\_call ::= subroutine\_call

list\_of\_arguments ::=

```

 [expression] { , [expression] } { , . identifier ([expression]) }
 | . identifier ([expression]) { , . identifier ([expression]) }

```

LRM 104

LRM 43

**method\_call ::=**

```

method_call_root . method_identifier { attribute_instance } [(list_of_arguments)]
+ expression . array_method_name { attribute_instance } [(list_of_arguments)]

```

LRM 113

LRM 140

```

with (expression)
method_call ::= method_call_root . method_call_body
method_call_body ::=
 method_identifier { attribute_instance } [(list_of_arguments)]
 | built_in_method_call
built_in_method_call ::=
 array_manipulation_call
 | randomize_call
array_manipulation_call ::=
 array_method_name { attribute_instance }
 [(list_of_arguments)]
 [with (expression)]
randomize_call ::=
 randomize { attribute_instance }
 [([variable_identifier_list | null])]
 [with { { constraint_block } }]
method_call_root ::= expression | implicit_class_handle
array_method_name ::=
 method_identifier | unique | and | or | xor

```

LRM 248

### A.8.3 Expressions

```

base_expression ::= expression
inc_or_dec_expression ::=
 inc_or_dec_operator { attribute_instance } variable_lvalue
 | variable_lvalue { attribute_instance } inc_or_dec_operator
conditional_expression ::= cond_predicate ? { attribute_instance } expression : expression
constant_base_expression ::= constant_expression
constant_expression ::=
 constant_primary
 | unary_operator { attribute_instance } constant_primary
 | constant_expression binary_operator { attribute_instance } constant_expression
 | constant_expression ? { attribute_instance } constant_expression : constant_expression
string_literal
constant_mintypmax_expression ::=
 constant_expression
 | constant_expression : constant_expression : constant_expression
constant_param_expression ::=
 constant_mintypmax_expression | data_type | $
param_expression ::= mintypmax_expression | data_type
constant_range_expression ::= constant_expression | constant_range_or_indexed_range
constant_range_or_indexed_range ::= range | constant_indexed_range
constant_indexed_range ::=
 constant_base_expression +: width_constant_expression
 | constant_base_expression -: width_constant_expression
dimension_constant_expression ::= constant_expression
expression ::=
 primary
 | unary_operator { attribute_instance } primary
 | inc_or_dec_expression

```

LRM 100

LRM 122

LRM 275

LRM 39

LRM 135

LRM 160

LRM 100

```

 | (operator_assignment)
 | expression binary_operator { attribute_instance } expression
 | conditional_expression
 | string_literal
 | inside_expression
 | tagged_union_expression
tagged_union_expression ::=
 tagged member_identifier [expression]
inside_expression ::= expression inside { open_range_list }
range_list_or_array ::=
 variable_identifier
 | { value_range { , value_range } }
value_range ::=
 expression
 | [expression : expression]
lsb_constant_expression ::= constant_expression
mintypmax_expression ::=
 expression
 | expression : expression : expression
module_path_conditional_expression ::= module_path_expression ? { attribute_instance }
 module_path_expression : module_path_expression
module_path_expression ::=
 module_path_primary
 | unary_module_path_operator { attribute_instance } module_path_primary
 | module_path_expression binary_module_path_operator { attribute_instance }
 module_path_expression
 | module_path_conditional_expression
module_path_mintypmax_expression ::=
 module_path_expression
 | module_path_expression : module_path_expression : module_path_expression
msb_constant_expression ::= constant_expression
range_expression ::= expression | range_or_indexed_range
range_or_indexed_range ::= range | indexed_range
indexed_range ::=
 base_expression +: width_constant_expression
 | base_expression -: width_constant_expression
width_constant_expression ::= constant_expression

```

LRM 69

LRM 173

LRM 275

LRM 113  
LRM 122

LRM 105

LRM 202

LRM 160

### A.8.4 Primaries

```

constant_primary ::=
 primary_literal
 | ps_parameter_identifier
 | ps_specparam_identifier
 | genvar_identifier
 | [package_scope | class_scope] enum_identifier
 | constant_concatenation
 | constant_multiple_concatenation
 | constant_function_call
 | (constant_mintypmax_expression)
 | constant_cast

```

LRM 160

LRM 249



```

module_path_primary ::=
 number
 | identifier
 | module_path_concatenation
 | module_path_multiple_concatenation
 | function_subroutine_call
 | (module_path_mintypmax_expression)

```

LRM 173

LRM 113

```

primary ::=
 primary_literal
 | [implicit_class_handle . | class_scope | package_scope] hierarchical_identifier select
 | class_scope :: identifier select
 | empty_queue
 | concatenation
 | multiple_concatenation
 | function_subroutine_call
 | (mintypmax_expression)
 | cast
 | streaming_expression
 | sequence_method_call
 | $24
 | null

```

LRM 8

LRM 160

LRM 249

LRM 39  
LRM 41  
LRM 43  
LRM 69  
LRM 109

LRM 173

```

time_literal5 ::=
 unsigned_number time_unit
 | fixed_point_number time_unit

```

time\_unit ::= **s** | **ms** | **us** | **ns** | **ps** | **fs** | **step**

```

implicit_class_handle7 ::= this | super | this . super

```

LRM 113

```

select ::= { [expression] } [[range_or_indexed_range]]

```

LRM 160

```

constant_select ::= { [expression] } [[range_or_indexed_range]]

```

```

primary_literal ::= number | time_literal | unbased_unsized_literal | string_literal

```

LRM 275

```

constant_cast ::=
 casting_type ' (constant_expression)
 | casting_type ' constant_concatenation
 | casting_type ' constant_multiple_concatenation

```

```

cast ::=
 casting_type ' (expression)
 | casting_type ' concatenation
 | casting_type ' multiple_concatenation

```

### A.8.5 Expression left-side values

```

net_lvalue ::=
 ps_or_hierarchical_net_identifier constant_select
 | { net_lvalue { , net_lvalue } }

```

LRM 249

LRM 160

```

variable_lvalue ::=
 [implicit_class_handle . | package_scope] hierarchical_variable_identifier select
 | { variable_lvalue { , variable_lvalue } }

```

LRM 113

LRM 160

### A.8.6 Operators

```

unary_operator ::=
 + | - | ! | ~ | & | ~& | | | ~| | ^ | ~^ | ^~

```

```

binary_operator ::=
 + | - | * | / | % | == | != | === | !== | ==? | !=? | && | || | **

```

```

 | < | <= | > | >= | & | | ^ | ^~ | ~^ | >> | << | >>> | <<<
inc_or_dec_operator ::= ++ | --
unary_module_path_operator ::=
 ! | ~ | & | ~& | | | ~ | ^ | ~^ | ^~
binary_module_path_operator ::=
 == | != | && | || | & | | ^ | ^~ | ~^

```

### A.8.7 Numbers

```

number ::=
 integral_number
 | real_number
integral_number ::=
 decimal_number
 | octal_number
 | binary_number
 | hex_number
decimal_number ::=
 unsigned_number
 | [size] decimal_base unsigned_number
 | [size] decimal_base x_digit { _ }
 | [size] decimal_base z_digit { _ }
binary_number ::= [size] binary_base binary_value
octal_number ::= [size] octal_base octal_value
hex_number ::= [size] hex_base hex_value
sign ::= + | -
size ::= non_zero_unsigned_number
non_zero_unsigned_number1 ::= non_zero_decimal_digit { _ | decimal_digit }
real_number1 ::=
 fixed_point_number
 | unsigned_number [. unsigned_number] exp [sign] unsigned_number
fixed_point_number1 ::= unsigned_number . unsigned_number
exp ::= e | E
unsigned_number1 ::= decimal_digit { _ | decimal_digit }
binary_value1 ::= binary_digit { _ | binary_digit }
octal_value1 ::= octal_digit { _ | octal_digit }
hex_value1 ::= hex_digit { _ | hex_digit }
decimal_base1 ::= '[sS]d' | '[sS]D'
binary_base1 ::= '[sS]b' | '[sS]B'
octal_base1 ::= '[sS]o' | '[sS]O'
hex_base1 ::= '[sS]h' | '[sS]H'
non_zero_decimal_digit ::= 1 | 2 | 3 | 4 | 5 | 6 | 7 | 8 | 9
decimal_digit ::= 0 | 1 | 2 | 3 | 4 | 5 | 6 | 7 | 8 | 9
binary_digit ::= x_digit | z_digit | 0 | 1
octal_digit ::= x_digit | z_digit | 0 | 1 | 2 | 3 | 4 | 5 | 6 | 7

```

LRM 125

hex\_digit ::= x\_digit | z\_digit | **0 | 1 | 2 | 3 | 4 | 5 | 6 | 7 | 8 | 9 | a | b | c | d | e | f | A | B | C | D | E | F**

x\_digit ::= **x | X**

z\_digit ::= **z | Z | ?**

unbased\_unsized\_literal ::= **'0 | '1** | 'z\_or\_x <sup>11</sup>

LRM 160

### A.8.8 Strings

string\_literal ::= " { Any\_ASCII\_Characters } "

## A.9 General

### A.9.1 Attributes

attribute\_instance ::= **( \* attr\_spec { , attr\_spec } \* )**

attr\_spec ::= attr\_name [ = constant\_expression ]

attr\_name ::= identifier

LRM 18

### A.9.2 Comments

comment ::=

    one\_line\_comment  
    | block\_comment

one\_line\_comment ::= // comment\_text \n

block\_comment ::= /\* comment\_text \*/

comment\_text ::= { Any\_ASCII\_character }

### A.9.3 Identifiers

array\_identifier ::= identifier

block\_identifier ::= identifier

bin\_identifier ::= identifier

c\_identifier<sup>2</sup> ::= [ **a-zA-Z\_** ] { [ **a-zA-Z0-9\_** ] }

cell\_identifier ::= identifier

class\_identifier ::= identifier

class\_variable\_identifier ::= variable\_identifier

clocking\_identifier ::= identifier

config\_identifier ::= identifier

constraint\_identifier ::= identifier

covergroup\_identifier ::= identifier

covergroup\_variable\_identifier ::= variable\_identifier

cover\_point\_identifier ::= identifier

dynamic\_array\_variable\_identifier ::= variable\_identifier

enum\_identifier ::= identifier

escaped\_identifier ::= \ { any\_ASCII\_character\_except\_white\_space } white\_space

formal\_identifier ::= identifier

function\_identifier ::= identifier

generate\_block\_identifier ::= identifier

genvar\_identifier ::= identifier

hierarchical\_block\_identifier ::= hierarchical\_identifier

hierarchical\_dynamic\_array\_variable\_identifier ::= hierarchical\_variable\_identifier

hierarchical\_event\_identifier ::= hierarchical\_identifier

LRM 63  
LRM 65

LRM 59

LRM 65  
LRM 90

LRM 117

LRM 101

LRM 18

LRM 172

LRM 117

LRM 173

|                                                                                                      |         |
|------------------------------------------------------------------------------------------------------|---------|
| hierarchical_identifier ::= [ \$root . ] { identifier { { [ constant_expression ] } } . } identifier | LRM 101 |
| hierarchical_net_identifier ::= hierarchical_identifier                                              | LRM 270 |
| hierarchical_parameter_identifier ::= hierarchical_identifier                                        |         |
| hierarchical_task_identifier ::= hierarchical_identifier                                             | LRM 173 |
| hierarchical_tf_identifier ::= hierarchical_identifier                                               |         |
| hierarchical_variable_identifier ::= hierarchical_identifier                                         | LRM 173 |
| identifier ::=<br>simple_identifier<br>  escaped_identifier                                          |         |
| index_variable_identifier ::= identifier                                                             | LRM 249 |
| interface_identifier ::= identifier                                                                  | LRM 63  |
| interface_instance_identifier ::= identifier                                                         |         |
| inout_port_identifier ::= identifier                                                                 |         |
| input_port_identifier ::= identifier                                                                 |         |
| instance_identifier ::= identifier                                                                   |         |
| library_identifier ::= identifier                                                                    |         |
| member_identifier ::= identifier                                                                     | LRM 59  |
| method_identifier ::= identifier                                                                     |         |
| modport_identifier ::= identifier                                                                    |         |
| module_identifier ::= identifier                                                                     |         |
| net_identifier ::= identifier                                                                        | LRM 172 |
| output_port_identifier ::= identifier                                                                |         |
| package_identifier ::= identifier                                                                    | LRM 249 |
| package_scope ::=<br>package_identifier ::<br>  \$unit ::                                            |         |
| parameter_identifier ::= identifier                                                                  |         |
| port_identifier ::= identifier                                                                       |         |
| program_identifier ::= identifier                                                                    | LRM 172 |
| property_identifier ::= identifier                                                                   |         |
| ps_class_identifier ::= [ package_scope ] class_identifier                                           | LRM 249 |
| ps_covergroup_identifier ::= [ package_scope ] covergroup_identifier                                 |         |
| ps_identifier ::= [ package_scope ] identifier                                                       |         |
| ps_or_hierarchical_net_identifier ::= [ package_scope ] net_identifier   hierarchical_net_identifier |         |
| ps_or_hierarchical_tf_identifier ::= [ package_scope ] tf_identifier   hierarchical_tf_identifier    |         |
| ps_parameter_identifier ::= [ package_scope ] parameter_identifier                                   |         |
| ps_property_identifier ::= [ package_scope ] property_identifier                                     |         |
| ps_sequence_identifier ::= [ package_scope ] sequence_identifier                                     |         |
| ps_specparam_identifier ::= [ package_scope ] specparam_identifier                                   |         |
| ps_type_identifier ::= [ package_scope ] type_identifier                                             |         |
| sequence_identifier ::= identifier                                                                   |         |
| signal_identifier ::= identifier                                                                     |         |
| simple_identifier <sup>2</sup> ::= [ a-zA-Z_ ] { [ a-zA-Z0-9_\$ ] }                                  | LRM 101 |
| specparam_identifier ::= identifier                                                                  |         |

system\_tf\_identifier<sup>3</sup> ::= \$[ a-zA-Z0-9\_\$ ]{ [ a-zA-Z0-9\_\$ ] }

LRM 173

task\_identifier ::= identifier

tf\_identifier ::= identifier

LRM 173

terminal\_identifier ::= identifier

topmodule\_identifier ::= identifier

LRM 18

type\_identifier ::= identifier

LRM 89

udp\_identifier ::= identifier

LRM 172

variable\_identifier ::= identifier

LRM 39  
LRM 101

#### A.9.4 White space

white\_space ::= space | tab | newline | eof<sup>4</sup>

LRM 145

#### A.10 Notes Footnotes (normative)

LRM 236

- 1) Embedded spaces are illegal.
- 2) A simple\_identifier, c\_identifier, and arrayed\_reference shall start with an alpha or underscore ( \_ ) character, shall have at least one character, and shall not have any spaces.
- 3) The \$ character in a system\_tf\_identifier shall not be followed by white\_space. A system\_tf\_identifier shall not be escaped.
- 4) End of file.
- 5) The unsigned number or fixed point number in time\_literal shall not be followed by a white\_space.
- 6) The signed and unsigned keywords shall not be used within a function data type. Void functions, non integer type functions, unpacked structure or union functions, and functions with a typedef type cannot have a signing declaration.
- 7) implicit\_class\_handle shall only appear within the scope of a class\_declaration or extern\_method\_declaration out-of-block method declaration.
- 8) In any one declaration, only one of protected or local is allowed, only one of rand or randc is allowed, and static and/or virtual can appear only once.
- 9) dpi\_function\_proto return types are restricted to small values, as per 27.4.5.
- 10) Formals of dpi\_function\_proto and dpi\_task\_proto cannot use pass by reference mode and class types cannot be passed at all; for the complete set of restrictions see 27.4.6.
- 11) The apostrophe ( ` ) in unbased\_unsized\_literal shall not be followed by white\_space.
- 12) unsized\_dimension is permitted only in declarations of import DPI functions, see dpi\_function\_proto.
- 13) More than one unsized dimension is permitted only in declarations of import DPI functions, see dpi\_function\_proto.
- 14) When a packed dimension is used with the struct or union keyword, the packed keyword shall also be used.
- 15) A charge strength shall only be used with the triereg keyword. When the vectored or scalared keyword is used, there shall be at least one packed dimension.
- 16) In a data\_declaration that is not within the procedural context, it shall be illegal to use the automatic keyword.

LRM 101

LRM 173

LRM 45

LRM 77

LRM 249

LRM 132

LRM 160

LRM 45

LRM 45

LRM 59

- 17) It shall be legal to omit the `covergroup_variable_identifier` from a `covergroup` instantiation only if this implicit instantiation is within a class that has no other instantiation of the `covergroup`. LRM 65
- 18) The `.*` token shall appear at most once in a list of port connections. LRM 93
- 19) A `timeunits_declaration` shall be legal as a `non_port_module_item`, `non_port_interface_item`, `non_port_program_item`, `package_item` or `class_item` only if it repeats and matches a previous `timeunits_declaration` within the same time scope. LRM 99
- 20) In a `multiple_concatenation`, it shall be illegal for the multiplier not to be a `constant_expression` unless the type of the concatenation is string. LRM 100
- ~~21) The `with` clause of a method call shall be legal only for the array (or queue) methods of Section 4.15.~~ LRM 113
- 21) In a shallow copy the expression must evaluate to an object handle. LRM 248
- 22) It shall be legal to use the `$` primary in an `open_value_range` of the form `[ expression : $ ]` or `[ $ : expression ]`. LRM 117  
LRM 160
- 23) `{ }` shall only be legal in the context of a queue.
- 24) The `$` primary shall be legal only in a `select` for a queue variable or in an `open_value_range`.
- 25) A `type_identifier` shall be legal as an `enum_base_type` if it denotes an `integer_atom_type`, with which additional packed dimensions are not permitted, or an `integer_vector_type`. LRM 170
- 26) In a `constant_function_call`, all arguments shall be `constant_expressions`. LRM 173
- 27) The `list_of_port_declarations` syntax is explained in Section 18.8, which also imposes various semantic restrictions, e.g., a `ref` port must be of a variable type and an `inout` port must not be. It shall be illegal to initialize a port that is not a variable `output` port. LRM 243
- 28) It shall be legal to declare a `void struct_union_member` only within tagged unions.

## Annex B

### Keywords

SystemVerilog reserves the following keywords listed in Table B-1:

#### Legend:

- † keywords added to the IEEE 1364 Verilog-2001 standard as part of SystemVerilog 3.0
- ‡ keywords added to the IEEE 1364 Verilog-2001 standard as part of SystemVerilog 3.1
- \* keywords added to the IEEE 1364 Verilog-2001 standard as part of SystemVerilog 3.1a

Table B-1: Reserved keywords

|                            |                               |                             |                            |
|----------------------------|-------------------------------|-----------------------------|----------------------------|
| alias <sup>†</sup>         | endinterface <sup>†</sup>     | macromodule                 | showcancelled              |
| always                     | endmodule                     | matches <sup>*</sup>        | signed                     |
| always_comb <sup>†</sup>   | <b>endpackage<sup>*</sup></b> | medium                      | small                      |
| always_ff <sup>†</sup>     | endprimitive                  | modport <sup>†</sup>        | solve <sup>†</sup>         |
| always_latch <sup>†</sup>  | endprogram <sup>†</sup>       | module                      | specify                    |
| and                        | endproperty <sup>†</sup>      | nand                        | specparam                  |
| assert <sup>†</sup>        | endspecify                    | negedge                     | static <sup>†</sup>        |
| assert_strobe <sup>†</sup> | endsequence <sup>†</sup>      | new <sup>†</sup>            | string <sup>†</sup>        |
| assign                     | endtable                      | nmos                        | strong0                    |
| assume <sup>*</sup>        | endtask                       | nor                         | strong1                    |
| automatic                  | enum <sup>†</sup>             | noshowcancelled             | struct <sup>†</sup>        |
| before <sup>†</sup>        | event                         | not                         | super <sup>†</sup>         |
| begin                      | expect <sup>*</sup>           | notif0                      | supply0                    |
| bind <sup>†</sup>          | export <sup>†</sup>           | notif1                      | supply1                    |
| bins <sup>*</sup>          | extends <sup>†</sup>          | null <sup>†</sup>           | table                      |
| binsof <sup>*</sup>        | extern <sup>†</sup>           | or                          | tagged <sup>*</sup>        |
| bit <sup>†</sup>           | final <sup>†</sup>            | output                      | task                       |
| break <sup>†</sup>         | first_match <sup>†</sup>      | <b>package<sup>*</sup></b>  | this <sup>†</sup>          |
| buf                        | for                           | packed <sup>†</sup>         | throughout <sup>†</sup>    |
| bufif0                     | force                         | parameter                   | time                       |
| bufif1                     | <b>foreach<sup>*</sup></b>    | pmos                        | timeprecision <sup>†</sup> |
| byte <sup>†</sup>          | forever                       | posedge                     | timeunit <sup>†</sup>      |
| case                       | fork                          | primitive                   | tran                       |
| casex                      | forkjoin <sup>†</sup>         | priority <sup>†</sup>       | tranif0                    |
| casez                      | function                      | program <sup>†</sup>        | tranif1                    |
| cell                       | generate                      | property <sup>†</sup>       | tri                        |
| chandle <sup>†</sup>       | genvar                        | protected <sup>†</sup>      | tri0                       |
| class <sup>†</sup>         | highz0                        | pull0                       | tri1                       |
| clocking <sup>†</sup>      | highz1                        | pull1                       | triand                     |
| cmos                       | if                            | pulldown                    | trior                      |
| config                     | iff <sup>†</sup>              | pullup                      | trireg                     |
| const <sup>†</sup>         | ifnone                        | pulsestyle_onevent          | type <sup>†</sup>          |
| constraint <sup>†</sup>    | ignore_bins <sup>*</sup>      | pulsestyle_ondetect         | typedef <sup>†</sup>       |
| context <sup>†</sup>       | illegal_bins <sup>*</sup>     | pure <sup>†</sup>           | union <sup>†</sup>         |
| continue <sup>†</sup>      | import <sup>†</sup>           | rand <sup>†</sup>           | unique <sup>†</sup>        |
| cover <sup>†</sup>         | indir                         | randc <sup>†</sup>          | unsigned                   |
| covergroup <sup>*</sup>    | include                       | <b>randcase<sup>*</sup></b> | use                        |
| coverpoint <sup>*</sup>    | initial                       | randsequence <sup>*</sup>   | var <sup>†</sup>           |
| cross <sup>†</sup>         | inout                         | rcmos                       | vectored                   |
| deassign                   | input                         | <b>ref<sup>†</sup></b>      | virtual <sup>†</sup>       |
| default                    | inside <sup>†</sup>           | real                        | void <sup>†</sup>          |
| defparam                   | instance                      | realtime                    | wait                       |
| design                     | int <sup>†</sup>              | <b>ref<sup>†</sup></b>      | wait_order <sup>†</sup>    |
| disable                    | integer                       | reg                         | wand                       |
| dist <sup>†</sup>          | interface <sup>†</sup>        | release                     | weak0                      |
| do <sup>†</sup>            | intersect <sup>†</sup>        | repeat                      | weak1                      |
| edge                       | join                          | return <sup>†</sup>         | while                      |
| else                       | join_any <sup>†</sup>         | rnmos                       | wildcard <sup>*</sup>      |
| end                        | join_none <sup>†</sup>        | rpmos                       | wire                       |
| endcase                    | large                         | rtran                       | with <sup>†</sup>          |
| endclass <sup>†</sup>      | liblist                       | rtranif0                    | within <sup>†</sup>        |
| endclocking <sup>†</sup>   | library                       | rtranif1                    | wor                        |
| endconfig                  | local <sup>†</sup>            | scalared                    | xnor                       |
| endfunction                | localparam                    | sequence <sup>†</sup>       | xor                        |
| endgenerate                | logic <sup>†</sup>            | shortint <sup>†</sup>       |                            |
| endgroup <sup>*</sup>      | longint <sup>†</sup>          | shortreal <sup>†</sup>      |                            |

Draft 5

LRM 61  
LRM 62  
LRM 71

LRM 122

LRM 12

<sup>†</sup> keywords added to the IEEE 1364 Verilog-2001 standard as part of SystemVerilog 3.0-<sup>‡</sup> keywords added to the IEEE 1364 Verilog-2001 standard as part of SystemVerilog 3.1-<sup>\*</sup> keywords added to the IEEE 1364 Verilog-2001 standard as part of SystemVerilog 3.1a



Note: The keyword var is reserved for future extensions.

## Annex C

### Std Package

LRM 115

(Informative)

The standard package contains system types (see Section 7.10.1). The following types are provided by the std built-in package. The descriptions of the semantics of these types are defined in the indicated sections.

#### C.1 Semaphore

The semaphore class is described in Section 13.2 and its prototype is:

```
class semaphore;
 function new(int keyCount = 0);
 task put(int keyCount = 1);
 task get(int keyCount = 1);
 function int try_get(int keyCount = 1);
endclass
```

#### C.2 Mailbox

The mailbox class is described in Section 13.3 and its prototype is:

Note: *dynamic\_singular\_type* below represents a special type that enables run-time type-checking.

```
class mailbox #(type T = dynamic_singular_type) ;
 function new(int bound = 0);
 function int num();
 task put(T message);
 function int try_put(T message);
 task get(ref T message);
 function int try_get(ref T message);
 task peek(ref T message);
 function int try_peek(ref T message);
endclass
```

#### C.3 Randomize

The randomize function is described in Section 12.11 and its prototype is:

```
function int randomize(...);
```

The syntax for the randomize function is:

```
randomize(variable_identifier {, variable_identifier })
 [with constraint_block];
```

#### C.4 Process

The process class is described in Section 9.9 and its prototype is:

```
class process;
 enum state { FINISHED, RUNNING, WAITING, SUSPENDED, KILLED };

 static function process self();
 function state status();
 task kill();
 task await();
```

```
task suspend();
task resume();
endclass
```

## Annex D

### Linked Lists

(Informative)

The List package implements a classic list data-structure, and is analogous to the STL (Standard Template Library) List container that is popular with C++ programmers. The container is defined as a parameterized class, meaning that it can be customized to hold data of any type.

#### D.1 List definitions

*list*—A list is a doubly linked list, where every element has a predecessor and successor. A list is a sequence that supports both forward and backward traversal, as well as amortized constant time insertion and removal of elements at the beginning, end, or middle.

*container*—A container is a collection of data of the same type. Containers are objects that contain and manage other data. Containers provide an associated iterator that allows access to the contained data.

*iterator*—Iterators are objects that represent positions of elements in a container. They play a role similar to that of an array subscript, and allow users to access a particular element, and to traverse through the container.

#### D.2 List declaration

The List package supports lists of any arbitrary predefined type, such as `integer`, `string`, or class object.

Any iterator that refers to the position of an element that is removed from a list becomes invalid, thus, unable to iterate over the list.

To declare a specific list, users must first include the generic List class declaration from the standard include area and then declare the specialized list type:

```
`include <List.vh>
...
List#(type) dl; // dl is a List of 'type' elements
```

##### D.2.1 Declaring list variables

List variables are declared by providing a specialization of the generic list class:

```
List#(integer) il; // Object il is a list of integer
typedef List#(Packet) PList; // Class PList is a list of Packet objects
```

The List specialization declares a list of the indicated type. The type used in the list declaration determines the type of the data stored in the list elements.

##### D.2.2 Declaring list iterators

List iterators are declared by providing a specialization of the generic List\_Iterator class:

```
List_Iterator#(string) s; // Object s is a list-of-string iterator
List_Iterator#(Packet) p, q; // p and q are iterators to a list-of-Packet
```

#### D.3 Linked list class prototypes

The following class prototypes describe the generic List and List\_Iterator classes. Only the public interface is included here.

##### D.3.1 List\_Iterator class prototype

```
class List_Iterator#(parameter type T);
 extern function void next();
 extern function void prev();
 extern function int neq(List_Iterator#(T) iter);
 extern function int eq(List_Iterator#(T) iter);
 extern function T data();
endclass
```

### D.3.2 List class prototype

```
class List#(parameter type T);
 extern function new();
 extern function int size();
 extern function int empty();
 extern function void push_front(T value);
 extern function void push_back(T value);
 extern function T front();
 extern function T back();
 extern function void pop_front();
 extern function void pop_back();
 extern function List_Iterator#(T) start();
 extern function List_Iterator#(T) finish();
 extern function void insert(List_Iterator#(T) position, T value);
 extern function void insert_range(List_Iterator#(T) position,
 first, last);
 extern function void erase(List_Iterator#(T) position);
 extern function void erase_range(List_Iterator#(T) first, last);
 extern function void set(List_Iterator#(T) first, last);
 extern function void swap(List#(T) lst);
 extern function void clear();
 extern function void purge();
endclass
```

### D.4 List\_Iterator methods

The List\_Iterator class provides methods to iterate over the elements of lists. These methods are described below.

#### D.4.1 next()

```
function void next();
```

next changes the iterator so that it refers to the next element in the list.

#### D.4.2 prev()

```
function void prev();
```

prev changes the iterator so that it refers to the previous element in the list.

#### D.4.3 eq()

```
function int eq(List_Iterator#(T) iter);
```

eq compares two iterators, and returns 1 if both iterators refer to the same list element. Otherwise, it returns 0.

```
if(i1.eq(i2)) $display("both iterators refer to the same element");
```

#### D.4.4 neq()

```
function int neq(List_Iterator#(T) iter);
```

neq is the negation of eq(); it compares two iterators, and returns 0 if both iterators refer to the same list element. Otherwise, it returns 1.

#### D.4.5 data()

```
function T data();
```

data returns the data stored in the element at the given iterator location.

### D.5 List methods

The List class provides methods to query the size of the list, obtain iterators to the head or tail of the list, retrieve the data stored in the list, and methods to add, remove, and reorder the elements of the list.

#### D.5.1 size()

```
function int size();
```

size returns the number of elements stored in the list.

```
while (list1.size > 0) begin // loop while still elements in the list
 ...
end
```

#### D.5.2 empty()

```
function int empty();
```

empty returns 1 if the number elements stored in the list is zero, 0 otherwise.

```
if (list1.empty)
 $display("list is empty");
```

#### D.5.3 push\_front()

```
function void push_front(T value);
```

push\_front inserts the specified value at the front of the list.

```
List#(int) numbers;
numbers.push_front(10);
numbers.push_front(5); // numbers contains { 5 , 10 }
```

#### D.5.4 push\_back()

```
function void push_back(T value);
```

push\_back inserts the specified value at the end of the list.

```
List#(string) names;
names.push_back("Donald");
names.push_back("Mickey"); // names contains { "Donald", "Mickey" }
```

### D.5.5 front()

```
function T front();
```

front returns the data stored in the first element of the list (valid only if the list is not empty).

### D.5.6 back()

```
function T back();
```

back returns the data stored in the last element of the list (valid only if the list is not empty).

```
List#(int) numbers;
numbers.push_front(3);
numbers.push_front(2);
numbers.push_front(1);
$display(numbers.front, numbers.back); // displays 1 3
```

### D.5.7 pop\_front()

```
function void pop_front();
```

pop\_front removes the first element of the list. If the list is empty, this method is illegal and can generate an error.

### D.5.8 pop\_back()

```
function void pop_back();
```

pop\_back removes the last element of the list. If the list is empty, this method is illegal and can generate an error.

```
while (lp.size > 1) begin // remove all but the center element from
 // an odd-sized list lp
 lp.pop_front();
 lp.pop_back();
end
```

### D.5.9 start()

```
function List_Iterator#(T) start();
```

start returns an iterator to the position of the first element in the list.

### D.5.10 finish()

```
function List_Iterator#(T) finish();
```

finish returns an iterator to a position just past the last element in the list. The last element in the list can be accessed using finish.prev.

```
List#(int) lst; // display contents of list lst in position order
for (List_Iterator#(int) p = lst.start; p.neq(lst.finish); p.next)
 $display(p.data);
```

### D.5.11 insert()

```
function void insert(List_Iterator#(T) position, T value);
```

`insert` inserts the given data (value) into the list at the position specified by the iterator (before the element, if any, that was previously at the iterator's position). If the iterator is not a valid position within the list, then this operation is illegal and can generate an error.

```
function void add_sort(List#(byte) L, byte value);
 for (List_Iterator#(byte) p = L.start; p.neq(L.finish) ; p.next)
 if (p.data > value) begin
 lst.insert(p, value); // Add to sorted list (ascending order)
 end
 return;
end
endfunction
```

### D.5.12 `insert_range()`

```
function void insert_range(List_Iterator#(T) position, first, last);
```

`insert_range` inserts the elements contained in the list range specified by the iterators `first` and `last` at the specified list position (before the element, if any, that was previously at the position iterator). All the elements from `first` up to, but not including, `last` are inserted into the list. If the `last` iterator refers to an element before the `first` iterator, the range wraps around the end of the list. The range iterators can specify a range either in another list or in the same list as being inserted.

If the position iterator is not a valid position within the list, or if the range iterators are invalid (i.e., they refer to different lists or to invalid positions), then this operation is illegal and can generate an error.

### D.5.13 `erase()`

```
function void erase(List_Iterator#(T) position);
```

`erase` removes from the list the element at the specified position. After `erase()` returns, the position iterator becomes invalid.

```
list1.erase(list1.start); // same as pop_front
```

If the position iterator is not a valid position within the list, this operation is illegal and can generate an error.

### D.5.14 `erase_range()`

```
function void erase_range(List_Iterator#(T) first, last);
```

`erase_range` removes from a list the range of elements specified by the `first` and `last` iterators. This operation removes elements from the `first` iterator's position up to, but not including, the `last` iterator's position. If the `last` iterator refers to an element before the `first` iterator, the range wraps around the end of the list.

```
list1.erase_range(list1.start, list1.finish); // Remove all elements from
// list1
```

If the range iterators are invalid (i.e., they refer to different lists or to invalid positions), then this operation is illegal and can generate an error.

### D.5.15 `set()`

```
function void set(List_Iterator#(T) first, last);
```

`set` assigns to the list object the elements that lie in the range specified by the `first` and `last` iterators. After this method returns, the modified list shall have a size equal to the range specified by `first` and `last`. This method copies the data from the `first` iterator's position up to, but not including, the `last` iterator's position. If the `last` iterator refers to an element before the `first` iterator, the range wraps around the end of the list.

```
list2.set(list1.start, list2.finish); // list2 is a copy of list1
```



If the range iterators are invalid (i.e., they refer to different lists or to invalid positions), then this operation is illegal and can generate an error.

### D.5.16 swap()

```
function void swap(List#(T) lst);
```

swap exchanges the contents of two equal-size lists.

```
list1.swap(list2); // swap the contents of list1 to list2 and vice-versa
```

Swapping a list with itself has no effect. If the lists are of different sizes, this method can issue a warning.

### D.5.17 clear()

```
function void clear();
```

clear removes all the elements from a list, but not the list itself (i.e., the list header itself).

```
list1.clear(); // list1 becomes empty
```

### D.5.18 purge()

```
function void purge();
```

purge removes all the list elements (as in clear) and the list itself. This accomplishes the same effect as assigning null to the list. A purged list must be re-created using **new** before it can be used again.

```
list1.purge(); // same as list1 = null
```

## Annex E

### DPI C-layer

#### E.1 Overview

The SystemVerilog Direct Programming Interface (DPI) allows direct inter-language function calls between SystemVerilog and any foreign programming language with a C function call protocol and linking model:

- Functions implemented in C and given import declarations in SystemVerilog can be called from SystemVerilog; such functions are referred to as *imported functions*.
- Functions implemented in SystemVerilog and specified in export declarations can be called from C; such functions are referred to as *exported functions*.
- Tasks implemented in SystemVerilog and specified in export declarations can be called from C; such functions are referred to as *exported tasks*.
- Functions implemented in C which can be called from SystemVerilog, and can in turn call exported tasks, are referred to as *imported tasks*.

LRM 132

The SystemVerilog DPI supports only SystemVerilog data types, which are the sole data types that can cross the boundary between SystemVerilog and a foreign language in either direction. On the other hand, the data types used in C code shall be C types; hence, the duality of types.

A value that is passed through the Direct Programming Interface is specified in SystemVerilog code as a value of SystemVerilog type, while the same value shall be specified in C code as a value of C type. Therefore, a pair of matching type definitions is required to pass a value through DPI: the SystemVerilog definition and the C definition.

It is the user's responsibility to provide these matching definitions. A tool (such as a SystemVerilog compiler) can facilitate this by generating C type definitions for the SystemVerilog definitions used in DPI for imported and exported functions.

Some SystemVerilog types are directly compatible with C types; defining a matching C type for them is straightforward. There are, however, SystemVerilog-specific types, namely packed types (arrays, structures, and unions), 2-state or 4-state, which have no natural correspondence in C. DPI does not require any particular representation of such types and does not impose any restrictions on SystemVerilog implementations. This allows implementors to choose the layout and representation of packed types that best suits their simulation performance.

While not specifying the actual representation of packed types, this C-layer interface defines a canonical representation of packed 2-state and 4-state arrays. This canonical representation is actually based on legacy Verilog Programming Language Interface's (PLI's) *avalue/bvalue* representation of 4-state vectors. Library functions provide the translation between the representation used in a simulator and the canonical representation of packed arrays. There are also functions for bit selects and limited part selects for packed arrays, which do not require the use of the canonical representation.

Formal arguments in SystemVerilog can be specified as open arrays solely in import declarations; exported SystemVerilog functions cannot have formal arguments specified as open arrays. A formal argument is an open array when a range of one or more of its dimensions is unspecified (denoted in SystemVerilog by using empty square brackets (`[]`)). This corresponds to a relaxation of the DPI argument-matching rules (Section 27.5.1). An actual argument shall match the corresponding formal argument regardless of the range(s) for its corresponding dimension(s), which facilitates writing generalized C code that can handle SystemVerilog arrays of different sizes.

The C-layer of DPI basically uses normalized ranges. *Normalized ranges* mean `[n-1:0]` indexing for the packed part (packed arrays are restricted to one dimension) and `[0:n-1]` indexing for a dimension in the unpacked part of an array. Normalized ranges are used for the canonical representation of packed arrays in C and for System Verilog arrays passed as actual arguments to C, with the exception of actual arguments for open

arrays. The elements of an open array can be accessed in C by using the same range of indices as defined in SystemVerilog for the actual argument for that open array and the same indexing as in SystemVerilog.

Function arguments are generally passed by some form of reference or by value. All formal arguments, except open arrays, are passed by direct reference or value, and, therefore, are directly accessible in C code. Only small values of SystemVerilog input arguments (see Annex E.7.7) are passed by value. Formal arguments declared in SystemVerilog as open arrays are passed by a handle (type `svOpenArrayHandle`) and are accessible via library functions. Array-querying functions are provided for open arrays.

Depending on the data types used for imported or exported functions, either binary level or C-source level compatibility is granted. Binary level is granted for all data types that do not mix SystemVerilog packed and unpacked types and for open arrays which can have both packed and unpacked parts. If a data type that mixes SystemVerilog packed and unpacked types is used, then the C code needs to be re-compiled using the implementation-dependent definitions provided by the vendor.

The C-layer of the Direct Programming Interface provides two include files. The main include file, `svdpi.h`, is implementation-independent and defines the canonical representation, all basic types, and all interface functions. The second include file, `svdpi_src.h`, defines only the actual representation of packed arrays and, hence, its contents are implementation-dependent. Applications that do not need to include this file are binary-level compatible.

## E.2 Naming conventions

All names introduced by this interface shall conform to the following conventions.

- All names defined in this interface are prefixed with `sv` or `SV_`.
- Function and type names start with `sv`, followed by initially capitalized words with no separators, e.g., `svBitPackedArrRef`.
- Names of symbolic constants start with `sv_`, e.g., `sv_x`.
- Names of macro definitions start with `SV_`, followed by all upper-case words separated by a underscore (`_`), e.g., `SV_CANONICAL_SIZE`.

## E.3 Portability

Depending on the data types used for imported or exported tasks or functions, the C code can be binary-level or source-level compatible. Applications that do not use SystemVerilog packed types are always binary compatible. Applications that don't mix SystemVerilog packed and unpacked types in the same data type can be written to guarantee binary compatibility. Open arrays with both packed and unpacked parts are also binary compatible.

LRM 132

The values of SystemVerilog packed types can be accessed via interface tasks or functions using the canonical representation of 2-state and 4-state packed arrays, or directly through pointers using the implementation representation. The former mode assures binary level compatibility; the latter one allows for tool-specific, performance-oriented tuning of an application, though it also requires recompiling with the implementation-dependent definitions provided by the vendor and shipped with the simulator.

### E.3.1 Binary compatibility

*Binary compatibility* means an application compiled for a given platform shall work with every SystemVerilog simulator on that platform.

### E.3.2 Source-level compatibility

*Source-level compatibility* means an application needs to be re-compiled for each SystemVerilog simulator and implementation-specific definitions shall be required for the compilation.

## E.4 Include files

The C-layer of the Direct Programming Interface defines two include files corresponding to these two levels of

compatibility: `svdpi.h` and `svdpi_src.h`.

Binary compatibility of an application depends on the data types of the values passed through the interface. If all corresponding type definitions can be written in C without the need to include the `svdpi_src.h` file, then an application is binary compatible. If the `svdpi_src.h` file is required, then the application is not binary compatible and needs to be recompiled for each simulator of choice.

Applications that pass solely C-compatible data types or standalone packed arrays (both 2-state and 4-state) require only the `svdpi.h` file and, therefore, are binary compatible with all simulators. Applications that use complex data types which are constructed of both SystemVerilog packed arrays and C-compatible types also require the `svdpi_src.h` file and, therefore, are not binary compatible with all simulators. They are source-level compatible, however. If an application is tuned for a particular vendor-specific representation of packed arrays and therefore needs vendor specific include files, then such an application is not source-level compatible.

#### E.4.1 `svdpi.h` include file

Applications which use the Direct Programming Interface with C code usually need this main include file. The include file `svdpi.h` defines the types for canonical representation of 2-state (`bit`) and 4-state (`logic`) values and passing references to SystemVerilog data objects. The file also provides function headers and defines a number of helper macros and constants.

This document fully defines the `svdpi.h` file. The content of `svdpi.h` does not depend on any particular implementation or platform; all simulators shall use the same file. For more details on `svdpi.h`, see Annex E.9.1.

Applications which only use `svdpi.h` shall be binary-compatible with all SystemVerilog simulators.

#### E.4.2 `svdpi_src.h` include file

This is an auxiliary include file. `svdpi_src.h` defines data structures for implementation-specific representation of 2-state and 4-state SystemVerilog packed arrays. The interface specifies the contents of this file, i.e., what symbols are defined. The actual definitions of those symbols, however, are implementation-specific and shall be provided by vendors.

Applications that require the `svdpi_src.h` file are only source-level compatible, i.e., they need to be compiled with the version of `svdpi_src.h` provided for a particular implementation of SystemVerilog. If, however, an application makes use of the details of the implementation-specific representation of packed arrays and thus it requires vendor specific include files, then such an application is not source-level compatible.

### E.5 Semantic constraints

Note that the constraints expressed here merely restate those expressed in Section 27.4.1.

Formal and actual arguments of both imported tasks or functions and exported tasks or functions are bound by the principle “What You Specify Is What You Get.” This principle is binding both for the caller and for the callee, in C code and in SystemVerilog code. For the callee, it guarantees the actual arguments are as specified for the formal ones. For the caller, it means the function call arguments shall conform with the types of the formal arguments, which might require type-coercion on the caller side.

LRM 132

Another way to state this is that no compiler (either C or SystemVerilog) can make argument coercions between a caller’s declared formals and the callee’s declared the formals. This is because the callee’s formal arguments are declared in a different language than the caller’s formal arguments; hence there is no visible relationship between the two sets of formals. Users are expected to understand all argument relationships and provide properly matched types on both sides of the interface (see Annex E.6.2).

In SystemVerilog code, the compiler can change the formal arguments of a native SystemVerilog task or function and modify its code accordingly, because of optimizations, compiler pragmas, or command line switches. The situation is different for imported tasks and functions. A SystemVerilog compiler cannot modify the C code, perform any coercions, or make any changes whatsoever to the formal arguments of an imported task or

function.

A SystemVerilog compiler shall provide any necessary coercions for the actual arguments of every imported task and function call. For example, a SystemVerilog compiler might truncate or extend bits of a packed array if the widths of the actual and formal arguments are different. Similarly, a C compiler can provide coercion for C types based on the relationship of the arguments in the exported task's and function's C prototype (formals) and the exported task's and function's C call site (actuals). However, a C compiler cannot provide such coercion for SystemVerilog types.

Thus, in each case of an inter-language function call, either C to SystemVerilog or SystemVerilog to C, the compilers expect but cannot enforce that the types on either side are compatible. It is therefore the user's responsibility to ensure that the imported/exported function types exactly match the types of the corresponding tasks or functions in the foreign language.

### E.5.1 Types of formal arguments

The principle “What You Specify Is What You Get” guarantees the types of formal arguments of imported functions — an actual argument is guaranteed to be of the type specified for the formal argument, with the exception of open arrays (for which unspecified ranges are statically unknown). Formal arguments, other than open arrays, are fully defined by imported declaration; they shall have ranges of packed or unpacked arrays exactly as specified in the imported declaration. Only the SystemVerilog declaration site of the imported function is relevant for such formal arguments.

Formal arguments defined as open arrays have the size and ranges of the actual argument, i.e., have the ranges of packed or unpacked arrays exactly as that of the actual argument. The unsized ranges of open arrays are determined at a call site; the rest of the type information is specified at the import declaration. See also Annex E.6.1.

So, if a formal argument is declared as `bit [15:8] b []`, then it is the import declaration which specifies the formal argument is an unpacked array of packed bit array with bounds 15 to 8, while the actual argument used at a particular call site defines the bounds for the unpacked part for that call.

### E.5.2 input arguments

Formal arguments specified in SystemVerilog as `input` must not be modified by the foreign language code. See also Section 27.4.1.2.

### E.5.3 output arguments

The initial values of formal arguments specified in SystemVerilog as `output` are undetermined and implementation-dependent. See also Section 27.4.1.2.

### E.5.4 Value changes for output and inout arguments

The SystemVerilog simulator is responsible for handling value changes for `output` and `inout` arguments. Such changes shall be detected and handled after the control returns from C code to SystemVerilog code.

### E.5.5 context and non-context tasks and functions

LRM 132

Also refer to Section 27.4.3.

Some DPI imported tasks or functions or other interface functions called from them require that the context of their call be known. It takes special instrumentation of their call instances to provide such context; for example, a variable referring to the “current instance” might need to be set. To avoid any unnecessary overhead, imported tasks and function calls in SystemVerilog code are not instrumented unless the imported tasks or function is specified as context in its SystemVerilog import declaration.

LRM 132

All DPI export tasks and functions require that the context of their call is known. This occurs since SystemVerilog task and function declarations always occur in instantiable scopes, hence allowing a multiplicity of unique task and function instances in the simulator's elaborated database. Thus, there is no such thing as a non-context export task or function.

For the sake of simulation performance, a non-context imported task or function call shall not block SystemVerilog compiler optimizations. An imported task or function not specified as context shall not access any data objects from SystemVerilog other than its actual arguments. Only the actual arguments can be affected (read or written) by its call. Therefore, a call of non-context imported task or function is not a barrier for optimizations. A context imported task or function, however, can access (read or write) any SystemVerilog data objects by calling PLI/VPI, nor by calling an embedded export task or function. Therefore, a call to a context task or function is a barrier for SystemVerilog compiler optimizations.

Only the calls of context imported tasks and functions are properly instrumented and cause conservative optimizations; therefore, only those tasks and functions can safely call all functions from other APIs, including PLI and VPI functions or exported SystemVerilog functions. For imported task or functions not specified as context, the effects of calling PLI, VPI, or SystemVerilog functions can be unpredictable and such calls can crash if the callee requires a context that has not been properly set.

Special DPI utility functions exist that allow imported task and functions to retrieve and operate on their context. For example, the C implementation of an imported task or function can use `svGetScope()` to retrieve an `svScope` corresponding to the instance scope of its corresponding SystemVerilog import declaration. See Annex E.8 for more details.

### E.5.6 pure functions

See also Section 27.4.2.

Only non-void functions with no `output` or `inout` arguments can be specified as **pure**. Functions specified as **pure** in their corresponding SystemVerilog import declarations shall have no side effects; their results need to depend solely on the values of their input arguments. Calls to such functions can be removed by SystemVerilog compiler optimizations or replaced with the values previously computed for the same values of the input arguments.

Specifically, a **pure** function is assumed not to directly or indirectly (i.e., by calling other functions):

- perform any file operations
- read or write anything in the broadest possible meaning, includes i/o, environment variables, objects from the operating system or from the program or other processes, shared memory, sockets, etc.
- access any persistent data, like global or static variables.

If a **pure** function does not obey the above restrictions, SystemVerilog compiler optimizations can lead to unexpected behavior, due to eliminated calls or incorrect results being used.

### E.5.7 Memory management

See also Section 27.4.1.4.

The memory spaces owned and allocated by C code and SystemVerilog code are disjointed. Each side is responsible for its own allocated memory. Specifically, C code shall not free the memory allocated by SystemVerilog code (or the SystemVerilog compiler) nor expect SystemVerilog code to free the memory allocated by C code (or the C compiler). This does not exclude scenarios in which C code allocates a block of memory, then passes a handle (i.e., a pointer) to that block to SystemVerilog code, which in turn calls a C function that directly (if it is the standard function `free`) or indirectly frees that block.

NOTE—In this last scenario, a block of memory is allocated and freed in C code, even when the standard functions `malloc` and `free` are called directly from SystemVerilog code.

## E.6 Data types

This section defines the data types of the C-layer of the Direct Programming Interface.

### E.6.1 Limitations

Packed arrays can have an arbitrary number of dimensions; though they are eventually always equivalent to a one-dimensional packed array and treated as such. If the packed part of an array in the type of a formal argument in SystemVerilog is specified as multi-dimensional, the SystemVerilog compiler linearizes it. Although the original ranges are generally preserved for open arrays, if the actual argument has a multidimensional packed part of the array, it shall be normalized into an equivalent one-dimensional packed array.

NOTE—The actual argument can have both packed and unpacked parts of an array; either can be multidimensional.

## E.6.2 Duality of types: SystemVerilog types vs. C types

A value that crosses the Direct Programming Interface is specified in SystemVerilog code as a value of SystemVerilog type, while the same value shall be specified in C code as a value of C type. Therefore, each data type that is passed through the Direct Programming Interface requires two matching type definitions: the SystemVerilog definition and C definition.

The user needs to provide such matching definitions. Specifically, for each SystemVerilog type used in the import declarations or export declarations in SystemVerilog code, the user shall provide the equivalent type definition in C reflecting the argument passing mode for the particular type of SystemVerilog value and the direction (*input*, *output*, or *inout*) of the formal SystemVerilog argument. For values passed by reference, a generic pointer `void *` can be used (conveniently typedefed in `svdpi.h` or `svdpi_src.h`) without knowing the actual representation of the value.

## E.6.3 Data representation

DPI imposes the following additional restrictions on the representation of SystemVerilog data types.

- SystemVerilog types that are not packed and that do not contained packed elements have C compatible representation.
- Basic integer and real data types are represented as defined in Annex E.6.4.
- Enumeration types are represented as the types associated with them. Enumerated names are not available on C side of interface.
- Representation of packed types is implementation-dependent.
- Unpacked arrays embedded in a structure have C compatible layout regardless of the type of elements. Similarly, standalone arrays passed as actuals to a sized formal argument have C compatible representation.
- Standalone array passed as an actual to an open array formal
  - if the element type is scalar or packed then the representation is implementation dependent
  - otherwise the representation is C compatible. Therefore an element of an array shall have the same representation as an individual value of the same type. Hence, an array's elements can be accessed from C code via normal C array indexing similarly to doing so for individual values.
- The natural order of elements for each dimension in the layout of an unpacked array shall be used, i.e., elements with lower indices go first. For SystemVerilog range `[L:R]`, the element with SystemVerilog index `min(L,R)` has the C index 0 and the element with SystemVerilog index `max(L,R)` has the C index `abs(L-R)`.

NOTE—This does not actually impose any restrictions on how unpacked arrays are implemented; it only says an array that does not satisfy this condition shall not be passed as an actual argument for a formal argument which is a sized array; it can be passed, however, for a formal argument which is an unsized (i.e., open) array. Therefore, the correctness of an actual argument might be implementation-dependent. Nevertheless, an open array provides an implementation-independent solution; this seems to be a reasonable trade-off.

## E.6.4 Basic types

Table E-1 defines the mapping between the basic SystemVerilog data types and the corresponding C types.

**Table E-1: Mapping data types**

| SystemVerilog type              | C type                     |
|---------------------------------|----------------------------|
| <code>byte</code>               | <code>char</code>          |
| <code>shortint</code>           | <code>short int</code>     |
| <code>int</code>                | <code>int</code>           |
| <code>longint</code>            | <code>long long</code>     |
| <code>real</code>               | <code>double</code>        |
| <code>shortreal</code>          | <code>float</code>         |
| <code>chandle</code>            | <code>void*</code>         |
| <code>string</code>             | <code>char*</code>         |
| <code>bit</code> <sup>†</sup>   | <code>unsigned char</code> |
| <code>logic</code> <sup>†</sup> | <code>unsigned char</code> |

<sup>†</sup>Encodings for `bit` and `logic` are given in file `svdpi.h`. Refer to [Section Annex E.9.1.1](#).

LRM 217

The DPI interface also supports the SystemVerilog and C unsigned integer data types that correspond to the mappings Table E-1 shows for their signed equivalents.

The representation of SystemVerilog-specific data types like packed `bit` and `logic` arrays is implementation-dependent and generally transparent to the user. Nevertheless, for the sake of performance, applications can be tuned for a specific implementation and make use of the actual representation used by that implementation; such applications shall not be binary compatible, however.

### E.6.5 Normalized ranges

Packed arrays are treated as one-dimensional; the unpacked part of an array can have an arbitrary number of dimensions. Normalized ranges mean `[n-1:0]` indexing for the packed part and `[0:n-1]` indexing for a dimension of the unpacked part of an array. Normalized ranges are used for accessing all arguments but open arrays. The canonical representation of packed arrays also uses normalized ranges.

### E.6.6 Mapping between SystemVerilog ranges and normalized ranges

The SystemVerilog ranges for a formal argument specified as an open array are those of the actual argument for a particular call. Open arrays are accessible, however, by using their original ranges and the same indexing as in the SystemVerilog code.

For all other types of arguments, i.e., all arguments but open arrays, the SystemVerilog ranges are defined in the corresponding SystemVerilog import or export declaration. Normalized ranges are used for accessing such arguments in C code. The mapping between SystemVerilog ranges and normalized ranges is defined as follows.

- 1) If a packed part of an array has more than one dimension, it is linearized as specified by the equivalence of packed types (see Section 4.2).
- 2) A packed array of range `[L:R]` is normalized as `[abs(L-R) : 0]`; its most significant bit has a normalized index `abs(L-R)` and its least significant bit has a normalized index 0.
- 3) The natural order of elements for each dimension in the layout of an unpacked array shall be used, i.e., elements with lower indices go first. For SystemVerilog range `[L:R]`, the element with SystemVerilog



index  $\min(L, R)$  has the C index 0 and the element with SystemVerilog index  $\max(L, R)$  has the C index  $\text{abs}(L - R)$ .

NOTE—The above range mapping from SystemVerilog to C applies to calls made in both directions, i.e., SystemVerilog-calls to C and C-calls to SystemVerilog.

For example, if `logic [2:3] [1:3] [2:0] b [1:10] [31:0]` is used in SystemVerilog, it needs to be defined in C as if it were declared in SystemVerilog in the following normalized form: `logic [17:0] b [0:9] [0:31]`.

## E.6.7 Canonical representation of packed arrays

The Direct Programming Interface defines the canonical representation of packed 2-state (type `svBitVec32`) and 4-state arrays (type `svLogicVec32`). This canonical representation is derived from on the Verilog legacy PLI's `avalue/bvalue` representation of 4-state vectors. Library functions provide the translation between the representation used in a simulator and the canonical representation of packed arrays.

A packed array is represented as an array of one or more elements (of type `svBitVec32` for 2-state values and `svLogicVec32` for 4-state values), each element representing a group of 32 bits. The first element of an array contains the 32 least-significant bits, next element contains the 32 more-significant bits, and so on. The last element can contain a number of unused bits. The contents of these unused bits is undetermined and the user is responsible for the masking or the sign extension (depending on the sign) for the unused bits.

Table E-2 defines the encoding used for a packed `logic` array represented as `svLogicVec32`.

**Table E-2: Encoding of bits in `svLogicVec32`**

| c | d | Value |
|---|---|-------|
| 0 | 0 | 0     |
| 0 | 1 | 1     |
| 1 | 0 | z     |
| 1 | 1 | x     |

## E.7 Argument passing modes

This section defines the ways to pass arguments in the C-layer of the Direct Programming Interface.

### E.7.1 Overview

Imported and exported function arguments are generally passed by some form of a reference, with the exception of small values of SystemVerilog input arguments (see Annex E.11.7), which are passed by value. Similarly, the function result, which is restricted to small values, is passed by value, i.e., directly returned.

Actual arguments passed by reference typically are passed without changing their representation from the one used by a simulator. There is no inherent copying of arguments (other than any copying resulting from coercing).

Access to packed arrays via canonical representation involves copying arguments and does incur some overhead, however. Alternatively, for the sake of performance the application can be tuned for a particular tool and access the packed arrays directly through pointers using implementation representation, which could compromise binary and/or source compatibility. Data can be, however, moved around (copied, stored, retrieved) without using canonical representation while preserving binary or source level compatibility at the same time. This is possible by using pointers and size of data and when the detailed knowledge of the data representation is not required.

NOTE—This provides some degree of flexibility and allows the user to control the trade-off of performance vs. portability.

Formal arguments, except open arrays, are passed by direct reference or value, and, therefore, are directly accessible in C code. Formal arguments declared in SystemVerilog as open arrays are passed by a handle (type `svOpenArrayHandle`) and are accessible via library functions.

### E.7.2 Calling SystemVerilog tasks and functions from C

LRM 132

There is no difference in argument passing between calls from SystemVerilog to C and calls from C to SystemVerilog. Tasks and functions exported from SystemVerilog cannot have open arrays as arguments. Apart from this restriction, the same types of formal arguments can be declared in SystemVerilog for exported tasks and functions and imported tasks and functions. A task or function exported from SystemVerilog shall have the same function header in C as would an imported function with the same function result type and same formal argument list. In the case of arguments passed by reference, an actual argument to SystemVerilog task and function called from C shall be allocated using the same layout of data as SystemVerilog uses for that type of argument; the caller is responsible for the allocation. It can be done while preserving the binary compatibility, see Annex E.11.5 and Annex E.11.11.

LRM 132

Calling a SystemVerilog task from C is the same as calling a SystemVerilog function from C with the exception that the return type of an exported task is an int value which has a special meaning related to disable statements. Please see Section 27.8 for details on disable processing by DPI imported tasks and functions.

LRM 132

### E.7.3 Argument passing by value

Only small values of formal input arguments (see Annex E.11.7) are passed by value. Function results are also directly passed by value. The user needs to provide the C-type equivalent to the SystemVerilog type of a formal argument if an argument is passed by value.

### E.7.4 Argument passing by reference

For arguments passed by reference, their original simulator-defined representation shall be used and a reference (a pointer) to the actual data object is passed. The actual argument is usually allocated by a caller. The caller can also pass a reference to an object already allocated somewhere else, for example, its own formal argument passed by reference.

If an argument of type `T` is passed by reference, the formal argument shall be of type `T*`. However, packed arrays can also be passed using generic pointers `void*` (typedefed accordingly to `svBitPackedArrRef` or `svLogicPackedArrRef`).

### E.7.5 Allocating actual arguments for SystemVerilog-specific types

This is relevant only for calling exported SystemVerilog functions from C code. The caller is responsible for allocating any actual arguments that are passed by reference.

Static allocation requires knowledge of the relevant data type. If such a type involves SystemVerilog packed arrays, their actual representation needs to be known to C code; thus, the file `svdpi_src.h` needs to be included, which makes the C code implementation-dependent and not binary compatible.

Sometimes binary compatibility can be achieved by using dynamic allocation functions. The functions `svSizeOfLogicPackedArr()` and `svSizeOfBitPackedArr()` provide the size of the actual representation of a packed array, which can be used for the dynamic allocation of an actual argument without compromising the portability (see Annex E.11.11). Such a technique does not work if a packed array is a part of another type.

### E.7.6 Argument passing by handle—open arrays

Arguments specified as open (unsized) arrays are always passed by a handle, regardless of direction of the SystemVerilog formal argument, and are accessible via library functions. The actual implementation of a handle is simulator-specific and transparent to the user. A handle is represented by the generic pointer `void *` (typedefed to `svOpenArrayHandle`). Arguments passed by handle shall always have a `const` qualifier, because the user shall not modify the contents of a handle.

## E.7.7 input arguments

**input** arguments of imported functions implemented in C shall always have a `const` qualifier.

**input** arguments, with the exception of open arrays, are passed by value or by reference, depending on the size. ‘Small’ values of formal input arguments are passed by value. The following data types are considered *small*:

- `byte`, `shortint`, `int`, `longint`, `real`, `shortreal`
- `chandle`, `string`
- `bit` (i.e., 2-state) packed arrays up to 32 bits (canonical representation shall be used, like for a function result; thus a small packed bit array shall be represented as `const svBitVec32`)

**input** arguments of other types are passed by reference.

If an **input** argument is a packed `bit` array passed by value, its value shall be represented using the canonical representation `svBitVec32`. If the size is smaller than 32 bits, the most significant bits are unused and their contents are undetermined. The user is responsible for the masking or the sign extension, depending on the sign, for the unused bits.

## E.7.8 inout and output arguments

**inout** and **output** arguments, with the exception of open arrays, are always passed by reference. Specifically, packed arrays are passed, accordingly, as `svBitPackedArrRef` or `svLogicPackedArrRef`. The same rules about unused bits apply as in Annex E.11.7.

## E.7.9 Function result

Types of a function result are restricted to the following SystemVerilog data types (see Table E-1 for the corresponding C type):

- `byte`, `shortint`, `int`, `longint`, `real`, `shortreal`, `chandle`, `string`
- packed `bit` arrays up to 32 bits
- scalar values of type `bit` and `logic`

LRM 217

Encodings for `bit` and `logic` are given in file `svdpi.h`. Refer to [Section Annex E.9.1.1](#).

If the function result type is a packed `bit` array, the returned value shall be represented using the canonical representation `svBitVec32`. If a packed `bit` array is smaller than 32 bits, the most significant bits are unused and their contents are undetermined.

## E.8 Context tasks and functions

LRM 132

Some DPI imported tasks and functions require that the context of their call is known. For example, those calls can be associated with instances of C models that have a one-to-one correspondence with instances of SystemVerilog modules that are making the calls. Alternatively, a DPI imported task or function might need to access or modify simulator data structures using PLI or VPI calls, or by making a call back into SystemVerilog via an export task or function. Context knowledge is required for such calls to function properly. It can take special instrumentation of their call to provide such context.

To avoid any unnecessary overhead, imported task and function calls in SystemVerilog code are not instrumented unless the imported task or function is specified as context in its SystemVerilog import declaration. A small set of DPI utility functions are available to assist programmers when working with context tasks or functions (see Annex E.8.3). If those utility functions are used with any non-context function, a system error shall result.

### E.8.1 Overview of DPI and VPI context

Both DPI task and functions and VPI/PLI functions might need to understand their context. However, the

LRM 132

meaning of the term is different for the two categories of task and functions.

DPI imported tasks and functions are essentially proxies for native SystemVerilog tasks and functions. Native SystemVerilog tasks and functions always operate in the scope of their declaration site. For example, a native SystemVerilog function  $f()$  can be declared in a module  $m$  which is instantiated as  $top.i1.m$ . The  $top.i1.m$  instance of  $f()$  can be called via hierarchical reference from code in a distant design region. Function  $f()$  is said to execute in the *context* (aka. instantiated scope) of  $top.i1.m$ , since it has unqualified visibility only for variables local to that specific instance of  $m$ . Function  $f()$  does not have unqualified visibility for any variables in the calling code's scope.

DPI imported tasks and functions follow the same model as native SystemVerilog tasks and functions. They execute in the context of their surrounding declarative scope, rather than the context of their call sites. This type of context is termed *DPI context*.

This is in contrast to VPI and PLI functions. Such functions execute in a context associated with their call sites. The VPI/PLI programming model relies on C code's ability to retrieve a context handle associated with the associated system task's call site, and then work with the context handle to glean information about arguments, items in the call site's surrounding declarative scope, etc. This type of context is termed *VPI context*.

Note that all DPI export tasks and functions require that the context of their call is known. This occurs since SystemVerilog task and function declarations always occur in instantiable scopes, hence giving rise to a multiplicity of associated task or function instances in the simulator's database. Thus, there is no such thing as a non-context export tasks or function. All export task and function calls must have their execution scope specified in advance by use of a context-setting API function.

### E.8.2 Context of imported and export tasks and functions

LRM 132

DPI imported and export tasks and functions can be declared anywhere a normal SystemVerilog task or function can be declared. Specifically, this means that they can be declared in **module**, **program**, **interface**, or **generate** declarative scope.

A context imported task or function executes in the context of the instantiated scope surrounding its declaration. This means that such tasks and functions can see other variables in that scope without qualification. As explained in Annex E.8.1, this should not be confused with the context of the task's or function's call site, which can actually be anywhere in the SystemVerilog design hierarchy. The context of an imported or exported task or function corresponds to the fully qualified name of the task or function, minus the task or function name itself.

Note that context is transitive through imported and export context tasks and functions declared in the same scope. That is, if an imported task or function is running in a certain context, and if it in turn calls an exported task or function that is available in the same context, the exported task or function can be called without any use of `svSetScope()`. For example, consider a SystemVerilog call to a native function  $f()$ , which in turn calls a native function  $g()$ . Now replace the native function  $f()$  with an equivalent imported context C function,  $f'()$ . The system shall behave identically regardless if  $f()$  or  $f'()$  is in the call chain above  $g()$ .  $g()$  has the proper execution context in both cases.

### E.8.3 Working with DPI context tasks and functions in C code

LRM 132

DPI defines a small set of functions to help programmers work with DPI context tasks and functions. The term *scope* is used in the task or function names for consistency with other SystemVerilog terminology. The terms *scope* and *context* are equivalent for DPI tasks and functions.

There are functions that allow the user to retrieve and manipulate the current operational scope. It is an error to use these functions with any C code that is not executing under a call to a DPI context imported task or function.

There are also functions that provide users with the power to set data specific to C models into the SystemVerilog simulator for later retrieval. These are the "put" and "get" user data functions, which are similar to facilities provided in VPI and PLI.

The put and get user data functions are flexible and allow for a number of use models. Users might wish to share user data across multiple context imported functions defined in the same SV scope. Users might wish to have unique data storage on a per function basis. Shared or unique data storage is controllable by a user-defined key.

To achieve shared data storage, a related set of context imported tasks and functions should all use the same userKey. To achieve unique data storage, a context import task or function should use a unique key. Note that it is a requirement on the user that such a key be truly unique from all other keys that could possibly be used by C code. This includes completely unknown C code that could be running in the same simulation. It is suggested that taking addresses of static C symbols (such as a function pointer, or address of some static C data) always be done for user key generation. Generating keys based on arbitrary integers is not a safe practice.

LRM 132

Note that it is never possible to share user data storage across different contexts. For example, if a Verilog module *m* declares a context imported task or function *f*, and *m* is instantiated more than once in the SystemVerilog design, then *f* shall execute under different values of *svScope*. No such executing instances of *f* can share user data with each other, at least not using the system-provided user data storage area accessible via `svPutUserData()`.

A user wanting to share a data area across multiple contexts must do so by allocating the common data area, then storing the pointer to it individually for each of the contexts in question via multiple calls to `svPutUserData()`. This is because, although a common user key can be used, the data must be associated with the individual scopes (denoted by *svScope*) of those contexts.

```

/* Functions for working with DPI context functions */

/* Retrieve the active instance scope currently associated with the executing
 * imported function.
 * Unless a prior call to svSetScope has occurred, this is the scope of the
 * function's declaration site, not call site.
 * The return value is undefined if this function is invoked from a non-context
 * imported function.
 */
svScope svGetScope();

/* Set context for subsequent export function execution.
 * This function must be called before calling an export function, unless
 * the export function is called while executing an extern function. In that
 * case the export function shall inherit the scope of the surrounding extern
 * function. This is known as the "default scope".
 * The return is the previous active scope (as per svGetScope)
 */
svScope svSetScope(const svScope scope);

/* Gets the fully qualified name of a scope handle */
const char* svGetNameFromScope(const svScope);

/* Retrieve svScope to instance scope of an arbitrary function declaration.
 * (can be either module, program, interface, or generate scope)
 * The return value shall be NULL for unrecognized scope names.
 */
svScope svGetScopeFromName(const char* scopeName);

/* Store an arbitrary user data pointer for later retrieval by svGetUserData()
 * The userKey is generated by the user. It must be guaranteed by the user to
 * be unique from all other userKey's for all unique data storage requirements
 * It is recommended that the address of static functions or variables in the
 * user's C code be used as the userKey.
 * It is illegal to pass in NULL values for either the scope or userData
 * arguments. It is also an error to call svPutUserData() with an invalid

```

```

 * svScope. This function returns -1 for all error cases, 0 upon success. It is
 * suggested that userData values of 0 (NULL) not be used as otherwise it can
 * be impossible to discern error status returns when calling svGetUserData()
 */
int svPutUserData(const svScope scope, void *userKey, void* userData);

/* Retrieve an arbitrary user data pointer that was previously
 * stored by a call to svPutUserData(). See the comment above
 * svPutUserData() for an explanation of userKey, as well as
 * restrictions on NULL and illegal svScope and userKey values.
 * This function returns NULL for all error cases, and a non-Null
 * user data pointer upon success.
 * This function also returns NULL in the event that a prior call
 * to svPutUserData() was never made.
 */
void* svGetUserData(const svScope scope, void* userKey);

/* Returns the file and line number in the SV code from which the extern call
 * was made. If this information available, returns TRUE and updates fileName
 * and lineNumber to the appropriate values. Behavior is unpredictable if
 * fileName or lineNumber are not appropriate pointers. If this information is
 * not available return FALSE and contents of fileName and lineNumber not
 * modified. Whether this information is available or not is implementation
 * specific. Note that the string provided (if any) is owned by the SV
 * implementation and is valid only until the next call to any SV function.
 * Applications must not modify this string or free it
 */
int svGetCallerInfo(char **fileName, int *lineNumber);

```

### E.8.4 Example 1 — Using DPI context functions

SV Side:

```

// Declare an imported context sensitive C function with cname "MyCFunc"
import "DPI" context MyCFunc = function integer MapID(int portID);

```

C Side:

```

// Define the function and model class on the C++ side:
class MyCModel {
private:
 int locallyMapped(int portID); // Does something interesting...
public:
 // Constructor
 MyCModel(const char* instancePath) {
 svScope svScope = svGetScopeByName(instancePath);

 // Associate "this" with the corresponding SystemVerilog scope
 // for fast retrieval during runtime.
 svPutUserData(svScope, (void*) MyCFunc, this);
 }

 friend int MyCFunc(int portID);
};

// Implementation of imported context function callable in SV
int MyCFunc(int portID) {
 // Retrieve SV instance scope (i.e. this function's context).
 svScope = svGetScope();
}

```

```
// Retrieve and make use of user data stored in SV scope
MyCModel* me = (MyCModel*)svGetUserData(svScope, (void*) MyCFunc);
return me->locallyMapped(portID);
}
```

## E.8.5 Relationship between DPI and VPI/PLI interfaces

DPI allows C code to run in the context of a SystemVerilog simulation, thus it is natural for users to consider using VPI/PLI C code from within imported tasks and functions.

LRM 132

There is no specific relationship defined between DPI and the existing Verilog programming interfaces (VPI and PLI). Programmers must make no assumptions about how DPI and the other interfaces interact. In particular, note that a `vpiHandle` is not equivalent to an `svOpenArrayHandle`, and the two must not be interchanged and passed between functions defined in two different interface standards.

If a user wants to call VPI or PLI functions from within an imported task or function, the imported task or function must be flagged with the context qualifier.

Not all VPI or PLI functionality is available from within DPI context imported tasks and functions. For example, a SystemVerilog imported task or function is not a system task, and thus making the following call from within an imported task or function would result in an error:

```
/* Get handle to system task call site in preparation for argument scan */
vpiHandle myHandle = vpi_handle(vpiSysTfCall, NULL);
```

Similarly, receiving `misctf` callbacks and other activities associated with system tasks are not supported inside DPI imported tasks and functions. Users should use VPI or PLI if they wish to accomplish such actions.

However, the following kind of code is guaranteed to work from within DPI context imported tasks and functions:

```
/* Prepare to scan all top level modules */
vpiHandle myHandle = vpi_iterate(vpiModule, NULL);
```

## E.9 Include files

The C-layer of the Direct Programming Interface defines two include files. The main include file, `svdpi.h`, is implementation-independent and defines the canonical representation, all basic types, and all interface functions. The second include file, `svdpi_src.h`, defines only the actual representation of packed arrays and, hence, is implementation-dependent. Both files are shown in Annex B.

Applications which do not need to include `svdpi_src.h` are binary-level compatible.

### E.9.1 Binary compatibility include file `svdpi.h`

Applications which use the Direct Programming Interface with C code usually need this main include file. The include file `svdpi.h` defines the types for canonical representation of 2-state (`bit`) and 4-state (`logic`) values and passing references to SystemVerilog data objects, provides function headers, and defines a number of helper macros and constants.

This document fully defines the `svdpi.h` file. The content of `svdpi.h` does not depend on any particular implementation or platform; all simulators shall use the same file. The following subsections (and Annex E.10.3.1) detail the contents of the `svdpi.h` file.

#### E.9.1.1 Scalars of type `bit` and `logic`

```
/* canonical representation */

#define sv_0 0
```

```

#define sv_1 1
#define sv_z 2 /* representation of 4-st scalar z */
#define sv_x 3 /* representation of 4-st scalar x */

/* common type for 'bit' and 'logic' scalars. */
typedef unsigned char svScalar;

typedef svScalar svBit; /* scalar */
typedef svScalar svLogic; /* scalar */

```

### E.9.1.2 Canonical representation of packed arrays

```

/* 2-state and 4-state vectors, modelled upon PLI's avalue/bvalue */
#define SV_CANONICAL_SIZE(WIDTH) (((WIDTH)+31)>>5)

typedef unsigned int
 svBitVec32; /* (a chunk of) packed bit array */

typedef struct { unsigned int c; unsigned int d;}
 svLogicVec32; /* (a chunk of) packed logic array */

/* Since the contents of the unused bits is undetermined, the following macros
can be handy */
#define SV_MASK(N) (~(-1<<(N)))

#define SV_GET_UNSIGNED_BITS(VALUE,N)\
 ((N)==32?(VALUE):((VALUE)&SV_MASK(N)))

#define SV_GET_SIGNED_BITS(VALUE,N)\
 ((N)==32?(VALUE):\
 (((VALUE)&(1<<(N)1))?(VALUE)|~SV_MASK(N)):((VALUE)&SV_MASK(N))))

```

### E.9.1.3 Implementation-dependent representation

```

/* a handle to a scope (an instance of a module or an interface) */
typedef void *svScope;

/* a handle to a generic object (actually, unsized array) */
typedef void* svOpenArrayHandle;

/* reference to a standalone packed array */
typedef void* svBitPackedArrRef;
typedef void* svLogicPackedArrRef;

/* total size in bytes of the simulator's representation of a packed array */
/* width in bits */
int svSizeOfBitPackedArr(int width);
int svSizeOfLogicPackedArr(int width);

```

### E.9.1.4 Translation between the actual representation and the canonical representation

```

/* functions for translation between the representation actually used by
simulator and the canonical representation */

/* s=source, d=destination, w=width */

/* actual <-- canonical */
void svPutBitVec32 (svBitPackedArrRef d, const svBitVec32* s, int w);
void svPutLogicVec32 (svLogicPackedArrRef d, const svLogicVec32* s, int w);

```



```

/* canonical <-- actual */
void svGetBitVec32 (svBitVec32* d, const svBitPackedArrRef s, int w);
void svGetLogicVec32 (svLogicVec32* d, const svLogicPackedArrRef s, int w);

```

The above functions copy the whole array in either direction. The user is responsible for providing the correct width and for allocating an array in the canonical representation. The contents of the unused bits is undetermined.

Although the put/get functionality provided for bit and logic packed arrays is sufficient, yet basic, it requires unnecessary copying of the whole packed array when perhaps only some bits are needed. For the sake of convenience and improved performance, bit selects and limited (up to 32 bits) part selects are also supported, see Annex E.10.3.1 and Annex E.10.3.2.

### E.9.2 Source-level compatibility include file `svdpi_src.h`

Only two symbols are defined: the macros that allow declaring variables to represent the SystemVerilog packed arrays of type bit or logic.

```

#define SV_BIT_PACKED_ARRAY(WIDTH,NAME) ...
#define SV_LOGIC_PACKED_ARRAY(WIDTH,NAME) ...

```

The actual definitions are implementation-specific. For example, a SystemVerilog simulator might define the later macro as follows.

```

#define SV_LOGIC_PACKED_ARRAY(WIDTH,NAME) \
 svLogicVec32 NAME [SV_CANONICAL_SIZE(WIDTH)]

```

### E.9.3 Example 2 — binary compatible application

SystemVerilog:

```

typedef struct {int a; int b;} pair;
import "DPI" function void foo(input int i1, pair i2, output logic [63:0] o3);

export "DPI" function exported_sv_func;

function void exported_sv_func(input int i, output int o [0:7]);
 begin ... end
endfunction

```

C:

```

#include "svdpi.h"

typedef struct {int a; int b;} pair;

extern void exported_sv_func(int, int *); /* imported from SystemVerilog */

void foo(const int i1, const pair *i2, svLogicPackedArrRef o3)
{
 svLogicVec32 arr[SV_CANONICAL_SIZE(64)]; /* 2 chunks needed */
 int tab[8];

 printf("%d\n", i1);
 arr[1].c = i2->a;
 arr[1].d = 0;
 arr[2].c = i2->b;
 arr[2].d = 0;
 svPutLogicVec32 (o3, arr, 64);
}

```

```

 /* call SystemVerilog */
 exported_sv_func(i1, tab); /* tab passed by reference */
 ...
}

```

### E.9.4 Example 3— source-level compatible application

SystemVerilog:

```

typedef struct {int a; bit [6:1][1:8] b [65:2]; int c;} triple;
// troublesome mix of C types and packed arrays
import "DPI" function void foo(input triple i);

export "DPI" function exported_sv_func;

function void exported_sv_func(input int i, output logic [63:0] o);
 begin ... end
endfunction

```

C:

```

#include "svdpi.h"
#include "svdpi_src.h"

typedef struct {
 int a;
 sv_BIT_PACKED_ARRAY(6*8, b) [64]; /* implementation specific
 representation */
 int c;
} triple;

/* Note that 'b' is defined as for 'bit [6*8-1:0] b [63:0]' */

extern void exported_sv_func(int, svLogicPackedArrRef); /* imported from
 SystemVerilog */

void foo(const triple *i)
{
 int j;
 /* canonical representation */
 svBitVec32 arr[SV_CANONICAL_SIZE(6*8)]; /* 6*8 packed bits */
 svLogicVec32 aL[SV_CANONICAL_SIZE(64)];

 /* implementation specific representation */
 SV_LOGIC_PACKED_ARRAY(64, my_tab);

 printf("%d %d\n", i->a, i->c);
 for (j=0; j<64; j++) {
 svGetBitVec32(arr, (svBitPackedArrRef)&(i->b[j]), 6*8);
 ...
 }
 ...
 /* call SystemVerilog */
 exported_sv_func(2, (svLogicPackedArrRef)&my_tab); /* by reference */
 svGetLogicVec32(aL, (svLogicPackedArrRef)&my_tab, 64); ... }

```

NOTE—*a*, *b*, and *c* are directly accessed as fields in a structure. In the case of *b*, which represents unpacked array of packed arrays, the individual element is accessed via the library function `svGetBitVec32()`, by passing its address to the function.

## E.10 Arrays

Normalized ranges are used for accessing SystemVerilog arrays, with the exception of formal arguments specified as open arrays.

### E.10.1 Multidimensional arrays

Packed arrays shall be one-dimensional. Unpacked arrays can have an arbitrary number of dimensions.

### E.10.2 Direct access to unpacked arrays

Unpacked arrays, with the exception of formal arguments specified as open arrays, shall have the same layout as used by a C compiler; they are accessed using C indexing (see Annex E.6.6).

### E.10.3 Access to packed arrays via canonical representation

Packed arrays are accessible via canonical representation; this C-layer interface provides functions for moving data between implementation representation and canonical representation (any necessary conversion is performed on-the-fly (see Annex E.9.1.3)), and for bit selects and limited (up to 32-bit) part selects. (Bit selects do not involve any canonical representation.)

#### E.10.3.1 Bit selects

This subsection defines the bit selects portion of the `svdpi.h` file (see Annex E.9.1 for more details).

```
/* Packed arrays are assumed to be indexed n-1:0,
 where 0 is the index of least significant bit */

/* functions for bit select */

/* s=source, i=bit-index */
svBit svGetSelectBit(const svBitPackedArrRef s, int i);
svLogic svGetSelectLogic(const svLogicPackedArrRef s, int i);

/* d=destination, i=bit-index, s=scalar */
void svPutSelectBit(svBitPackedArrRef d, int i, svBit s);
void svPutSelectLogic(svLogicPackedArrRef d, int i, svLogic s);
```

#### E.10.3.2 Part selects

Limited (up to 32-bit) part selects are supported. A part select is a slice of a packed array of types `bit` or `logic`. Array slices are not supported for unpacked arrays. Additionally, 64-bit wide part select can be read as a single value of type unsigned `long long`.

Functions for part selects only allow access (read/write) to a narrow subrange of up to 32 bits. A canonical representation shall be used for such narrow vectors. If the specified range of part select is not fully contained within the normalized range of an array, the behavior is undetermined.

For the convenience, bit type part selects are returned as a function result. In addition to a general function for narrow part selects ( $\leq 32$ -bits), there are two specialized functions for 32 and 64 bits.

```
/*
 * functions for part select
 *
 * a narrow (≤ 32 bits) part select is copied between
 * the implementation representation and a single chunk of
 * canonical representation
```

```

* Normalized ranges and indexing [n-1:0] are used for both arrays:
* the array in the implementation representation and the canonical array.
*
* s=source, d=destination, i=starting bit index, w=width
* like for variable part selects; limitations: w <= 32
*
* In part select operations, the data is copied to or from the
* canonical representation part ('chunk') designated by range [w-1:0]
* and the implementation representation part designated by range [w+i-1:i].
*/

```

LRM 277

NOTE—For the sake of symmetry, a canonical representation (i.e., an array) is used both for **bit** and **logic**, although a simpler **int** can be used for **bit**-part selects (<= 32-bits):

```

/* canonical <-- actual */
void svGetPartSelectBit(svBitVec32* d, const svBitPackedArrRef s, int i,
 int w);
svBitVec32 svGetBits(const svBitPackedArrRef s, int i, int w);
svBitVec32 svGet32Bits(const svBitPackedArrRef s, int i); // 32-bits
unsigned long long svGet64Bits(const svBitPackedArrRef s, int i); // 64-bits
void svGetPartSelectLogic(svLogicVec32* d, const svLogicPackedArrRef s, int i,
 int w);

/* actual <-- canonical */
void svPutPartSelectBit(svBitPackedArrRef d, const svBitVec32 s, int i,
 int w);
void svPutPartSelectLogic(svLogicPackedArrRef d, const svLogicVec32 s, int i,
 int w);

```

## E.11 Open arrays

Formal arguments specified as open arrays allows passing actual arguments of different sizes (i.e., different range and/or different number of elements), which facilitates writing more general C code that can handle SystemVerilog arrays of different sizes. The elements of an open array can be accessed in C by using the same range of indices and the same indexing as in SystemVerilog. Plus, inquiries about the dimensions and the original boundaries of SystemVerilog actual arguments are supported for open arrays.

NOTE—Both packed and unpacked array dimensions can be unsized.

All formal arguments declared in SystemVerilog as open arrays are passed by handle (type `svOpenArrayHandle`), regardless of the direction of a SystemVerilog formal argument. Such arguments are accessible via interface functions.

### E.11.1 Actual ranges

The formal arguments defined as open arrays have the size and ranges of the actual argument, as determined on a per-call basis. The programmer shall always have a choice whether to specify a formal argument as a sized array or as an open (unsized) array.

In the former case, all indices are normalized on the C side (i.e., 0 and up) and the programmer needs to know the size of an array and be capable of determining how the ranges of the actual argument map onto C-style ranges (see Annex E.6.6).

Tip: programmers can decide to use `[n:0] name [0:k]` style ranges in SystemVerilog.

In the later case, i.e., an open array, individual elements of a packed array are accessible via interface functions, which facilitate the SystemVerilog-style of indexing with the original boundaries of the actual argument.

If a formal argument is specified as a sized array, then it shall be passed by reference, with no overhead, and is

directly accessible as a normalized array. If a formal argument is specified as an open (unsized) array, then it shall be passed by handle, with some overhead, and is mostly indirectly accessible, again with some overhead, although it retains the original argument boundaries.

NOTE—This provides some degree of flexibility and allows the programmer to control the trade-off of performance vs. convenience.

The following example shows the use of sized vs. unsized arrays in SystemVerilog code.

```
// both unpacked arrays are 64 by 8 elements, packed 16-bit each
logic [15: 0] a_64x8 [63:0] [7:0];
logic [31:16] b_64x8 [64:1] [-1:-8];

import "DPI" function void foo(input logic [] i [] []);
 // 2-dimensional unsized unpacked array of unsized packed logic

import "DPI" function void boo(input logic [31:16] i [64:1] [-1:-8]);
 // 2-dimensional sized unpacked array of sized packed logic

foo(a_64x8);
foo(b_64x8); // C code can use original ranges [31:16] [64:1] [-1:-8]

boo(b_64x8); // C code must use normalized ranges [15:0] [0:63] [0:7]
```

### E.11.2 Array querying functions

These functions are modelled upon the SystemVerilog array querying functions and use the same semantics (see Section 23.7).

If the dimension is 0, then the query refers to the packed part (which is one-dimensional) of an array, and dimensions > 0 refer to the unpacked part of an array.

```
/* h= handle to open array, d=dimension */
int svLeft(const svOpenArrayHandle h, int d);
int svRight(const svOpenArrayHandle h, int d);
int svLow(const svOpenArrayHandle h, int d);
int svHigh(const svOpenArrayHandle h, int d);
int svIncrement(const svOpenArrayHandle h, int d);
int svLength(const svOpenArrayHandle h, int d);
int svDimensions(const svOpenArrayHandle h);
```

### E.11.3 Access functions

Similarly to sized arrays, there are functions for copying data between the simulator representation and the canonical representation and to obtain the actual address of SystemVerilog data object or of an individual element of an unpacked array. This information might be useful for simulator-specific tuning of the application.

Depending on the type of an element of an unpacked array, different access methods shall be used when working with elements.

- Packed arrays (`bit` or `logic`) are accessed via copying to or from the canonical representation.
- Scalars (1-bit value of type `bit` or `logic`) are accessed (read or written) directly.
- Other types of values (e.g., structures) are accessed via generic pointers; a library function calculates an address and the user needs to provide the appropriate casting.
- Scalars and packed arrays are accessible via pointers only if the implementation supports this functionality (per array), e.g., one array can be represented in a form that allows such access, while another array might

use a compacted representation which renders this functionality unfeasible (both occurring within the same simulator).

SystemVerilog allows arbitrary dimensions and, hence, an arbitrary number of indices. To facilitate this, variable argument list functions shall be used. For the sake of performance, specialized versions of all indexing functions are provided for 1, 2, or 3 indices.

#### E.11.4 Access to the actual representation

The following functions provide an actual address of the whole array or of its individual elements. These functions shall be used for accessing elements of arrays of types compatible with C. These functions are also useful for vendors, because they provide access to the actual representation for all types of arrays.

If the actual layout of the SystemVerilog array passed as an argument for an open unpacked array is different than the C layout, then it is not possible to access such an array as a whole; therefore, the address and size of such an array shall be undefined (zero (0), to be exact). Nonetheless, the addresses of individual elements of an array shall be always supported.

NOTE—No specific representation of an array is assumed here; hence, all functions use a generic pointer `void *`.

```

/* a pointer to the actual representation of the whole array of any type */
/* NULL if not in C layout */
void *svGetArrayPtr(const svOpenArrayHandle);

int svSizeOfArray(const svOpenArrayHandle); /* total size in bytes or 0 if not
 in C layout */

/* Return a pointer to an element of the array
 or NULL if index outside the range or null pointer */

void *svGetArrElemPtr(const svOpenArrayHandle, int indx1, ...);

/* specialized versions for 1-, 2- and 3-dimensional arrays: */
void *svGetArrElemPtr1(const svOpenArrayHandle, int indx1);
void *svGetArrElemPtr2(const svOpenArrayHandle, int indx1, int indx2);
void *svGetArrElemPtr3(const svOpenArrayHandle, int indx1, int indx2,
 int indx3);

```

Access to an individual array element via pointer makes sense only if the representation of such an element is the same as it would be for an individual value of the same type. Representation of array elements of type *scalar* or *packed value* is implementation-dependent; the above functions shall return NULL if the representation of the array elements differs from the representation of individual values of the same type.

#### E.11.5 Access to elements via canonical representation

This group of functions is meant for accessing elements which are packed arrays (bit or logic).

The following functions copy a single vector from a canonical representation to an element of an open array or other way round. The element of an array is identified by indices, bound by the ranges of the actual argument, i.e., the original SystemVerilog ranges are used for indexing.

```

/* functions for translation between simulator and canonical representations*/
/* s=source, d=destination */
/* actual <-- canonical */
void svPutBitArrElemVec32 (const svOpenArrayHandle d, const svBitVec32* s,
 int indx1, ...);
void svPutBitArrElem1Vec32(const svOpenArrayHandle d, const svBitVec32* s,
 int indx1);
void svPutBitArrElem2Vec32(const svOpenArrayHandle d, const svBitVec32* s,

```

```

 int indx1, int indx2);
void svPutBitArrElem3Vec32(const svOpenArrayHandle d, const svBitVec32* s,
 int indx1, int indx2, int indx3);

void svPutLogicArrElemVec32 (const svOpenArrayHandle d, const svLogicVec32* s,
 int indx1, ...);
void svPutLogicArrElem1Vec32(const svOpenArrayHandle d, const svLogicVec32* s,
 int indx1);
void svPutLogicArrElem2Vec32(const svOpenArrayHandle d, const svLogicVec32* s,
 int indx1, int indx2);
void svPutLogicArrElem3Vec32(const svOpenArrayHandle d, const svLogicVec32* s,
 int indx1, int indx2, int indx3);

/* canonical <-- actual */
void svGetBitArrElemVec32 (svBitVec32* d, const svOpenArrayHandle s,
 int indx1, ...);
void svGetBitArrElem1Vec32(svBitVec32* d, const svOpenArrayHandle s,
 int indx1);
void svGetBitArrElem2Vec32(svBitVec32* d, const svOpenArrayHandle s,
 int indx1, int indx2);
void svGetBitArrElem3Vec32(svBitVec32* d, const svOpenArrayHandle s,
 int indx1, int indx2, int indx3);

void svGetLogicArrElemVec32 (svLogicVec32* d, const svOpenArrayHandle s,
 int indx1, ...);
void svGetLogicArrElem1Vec32(svLogicVec32* d, const svOpenArrayHandle s,
 int indx1);
void svGetLogicArrElem2Vec32(svLogicVec32* d, const svOpenArrayHandle s,
 int indx1, int indx2);
void svGetLogicArrElem3Vec32(svLogicVec32* d, const svOpenArrayHandle s,
 int indx1, int indx2, int indx3);

```

The above functions copy the whole packed array in either direction. The user is responsible for allocating an array in the canonical representation.

### E.11.6 Access to scalar elements (bit and logic)

Another group of functions is needed for scalars (i.e., when an element of an array is a simple scalar, **bit**, or **logic**):

```

svBit svGetBitArrElem (const svOpenArrayHandle s, int indx1, ...);
svBit svGetBitArrElem1(const svOpenArrayHandle s, int indx1);
svBit svGetBitArrElem2(const svOpenArrayHandle s, int indx1, int indx2);
svBit svGetBitArrElem3(const svOpenArrayHandle s, int indx1, int indx2,
 int indx3);

svLogic svGetLogicArrElem (const svOpenArrayHandle s, int indx1, ...);
svLogic svGetLogicArrElem1(const svOpenArrayHandle s, int indx1);
svLogic svGetLogicArrElem2(const svOpenArrayHandle s, int indx1, int indx2);
svLogic svGetLogicArrElem3(const svOpenArrayHandle s, int indx1, int indx2,
 int indx3);

void svPutLogicArrElem (const svOpenArrayHandle d, svLogic value, int indx1,
 ...);
void svPutLogicArrElem1(const svOpenArrayHandle d, svLogic value, int indx1);
void svPutLogicArrElem2(const svOpenArrayHandle d, svLogic value, int indx1,
 int indx2);
void svPutLogicArrElem3(const svOpenArrayHandle d, svLogic value, int indx1,
 int indx2, int indx3);

```

```

void svPutBitArrElem (const svOpenArrayHandle d, svBit value, int indx1, ...);
void svPutBitArrElem1(const svOpenArrayHandle d, svBit value, int indx1);
void svPutBitArrElem2(const svOpenArrayHandle d, svBit value, int indx1,
 int indx2);
void svPutBitArrElem3(const svOpenArrayHandle d, svBit value, int indx1,
 int indx2, int indx3);

```

### E.11.7 Access to array elements of other types

If an array's elements are of a type compatible with C, there is no need to use canonical representation. In such situations, the elements are accessed via pointers, i.e., the actual address of an element shall be computed first and then used to access the desired element.

### E.11.8 Example 4— two-dimensional open array

SystemVerilog:

```

typedef struct {int i; ... } MyType;

import "DPI" function void foo(input MyType i [][]); /* 2-dimensional unsized
 unpacked array of MyType */

MyType a_10x5 [11:20][6:2];
MyType a_64x8 [64:1][-1:-8];

foo(a_10x5);
foo(a_64x8);

```

C:

```

#include "svdpi.h"

typedef struct {int i; ... } MyType;

void foo(const svOpenArrayHandle h)
{
 MyType my_value;
 int i, j;
 int lo1 = svLow(h, 1);
 int hi1 = svHigh(h, 1);
 int lo2 = svLow(h, 2);
 int hi2 = svHigh(h, 2);

 for (i = lo1; i <= hi1; i++) {
 for (j = lo2; j <= hi2; j++) {

 my_value = *(MyType *)svGetArrElemPtr2(h, i, j);
 ...
 *(MyType *)svGetArrElemPtr2(h, i, j) = my_value;
 ...
 }
 ...
 }
}

```

### E.11.9 Example 5 — open array

SystemVerilog:



```
typedef struct { ... } MyType;

import "DPI" function void foo(input MyType i [], output MyType o []);

MyType source [11:20];
MyType target [11:20];

foo(source, target);
```

C:

```
#include "svdpi.h"

typedef struct ... } MyType;

void foo(const svOpenArrayHandle hin, const svOpenArrayHandle hout)
{
 int count = svLength(hin, 1);
 MyType *s = (MyType *)svGetArrayPtr(hin);
 MyType *d = (MyType *)svGetArrayPtr(hout);

 if (s && d) { /* both arrays have C layout */

 /* an efficient solution using pointer arithmetic */
 while (count--)
 *d++ = *s++;

 /* even more efficient:
 memcpy(d, s, svSizeOfArray(hin));
 */

 } else { /* less efficient yet implementation independent */

 int i = svLow(hin, 1);
 int j = svLow(hout, 1);
 while (i <= svHigh(hin, 1)) {
 *(MyType *)svGetArrElemPtr1(hout, j++) =
 *(MyType *)svGetArrElemPtr1(hin, i++);
 }

 }

}
```

### E.11.10 Example 6 — access to packed arrays

SystemVerilog:

```
import "DPI" function void foo(input logic [127:0]);
import "DPI" function void boo(input logic [127:0] i []); // open array of
// 128-bit
```

C:

```
#include "svdpi.h"

/* one 128-bit packed vector */
void foo(const svLogicPackedArrRef packed_vec_128_bit)
```

```

{
 svLogicVec32 arr[SV_CANONICAL_SIZE(128)]; /* canonical representation */

 svGetLogicVec32(arr, packed_vec_128_bit, 128);
 ...
}

/* open array of 128-bit packed vectors */
void boo(const svOpenArrayHandle h)
{
 int i;
 svLogicVec32 arr[SV_CANONICAL_SIZE(128)]; /* canonical representation */

 for (i = svLow(h, 1); i <= svHigh(h, 1); i++) {

 svLogicPackedArrRef ptr = (svLogicPackedArrRef)svGetArrElemPtr1(h, i);
 /* user need not know the vendor representation! */

 svGetLogicVec32(arr, ptr, 128);
 ...
 }
 ...
}

```

### E.11.11 Example 7 — binary compatible calls of exported functions

This example demonstrates the source compatibility include file `svdpi_src.h` is not needed if a C function dynamically allocates the data structure for simulator representation of a packed array to be passed to an exported SystemVerilog function.

SystemVerilog:

```

export "DPI" function myfunc;
...
function void myfunc (output logic [31:0] r); ...
...

```

C:

```

#include "svdpi.h"
extern void myfunc (svLogicPackedArrRef r); /* exported from SV */

 /* output logic packed 32-bits */
 ...
 svLogicVec32 my_r[SV_CANONICAL_SIZE(32)];
 /* my array, canonical representation */

 /* allocate memory for logic packed 32-bits in simulator's representation */
 svLogicPackedArrRef r =
 (svLogicPackedArrRef)malloc(svSizeOfLogicPackedArr(32));
 myfunc(r);
 /* canonical <-- actual */
 svGetLogicVec32(my_r, r, 32);
 /* shall use only the canonical representation from now on */
 free(r); /* don't need any more */
 ...

```

## Annex F

### Include files

This annex shows the contents of the `svdpi.h` and `svdpi_src.h` include files.

#### F.1 Binary-level compatibility include file `svdpi.h`

```

/* canonical representation */

#define sv_0 0
#define sv_1 1
#define sv_z 2 /* representation of 4-st scalar z */
#define sv_x 3 /* representation of 4-st scalar x */

/* common type for 'bit' and 'logic' scalars. */
typedef unsigned char svScalar;

typedef svScalar svBit; /* scalar */
typedef svScalar svLogic; /* scalar */

/* Canonical representation of packed arrays */
/* 2-state and 4-state vectors, modelled upon PLI's avalue/bvalue */
#define SV_CANONICAL_SIZE(WIDTH) (((WIDTH)+31)>>5)

typedef unsigned int
 svBitVec32; /* (a chunk of) packed bit array */

typedef struct { unsigned int c; unsigned int d;}
 svLogicVec32; /* (a chunk of) packed logic array */

/* Since the contents of the unused bits is undetermined, the following macros can
 be handy */
#define SV_MASK(N) (~(-1<<(N)))

#define SV_GET_UNSIGNED_BITS(VALUE,N)\
 ((N)==32?(VALUE):((VALUE)&SV_MASK(N)))

#define SV_GET_SIGNED_BITS(VALUE,N)\
 ((N)==32?(VALUE):\
 (((VALUE)&(1<<((N)-1)))?((VALUE)|~SV_MASK(N)):((VALUE)&SV_MASK(N))))

/* implementation-dependent representation */

/* a handle to a scope (an instance of a module or interface) */
typedef void* svScope;

/* a handle to a generic object (actually, unsized array) */
typedef void* svOpenArrayHandle;

/* reference to a standalone packed array */
typedef void* svBitPackedArrRef;
typedef void* svLogicPackedArrRef;

/* total size in bytes of the simulator's representation of a packed array */
/* width in bits */
int svSizeOfBitPackedArr(int width);
int svSizeOfLogicPackedArr(int width);

```

```

/* Translation between the actual representation and canonical representation */

/* functions for translation between the representation actually used by
 simulator and the canonical representation */

/* s=source, d=destination, w=width */

/* actual <-- canonical */
void svPutBitVec32 (svBitPackedArrRef d, const svBitVec32* s, int w);
void svPutLogicVec32 (svLogicPackedArrRef d, const svLogicVec32* s, int w);

/* canonical <-- actual */
void svGetBitVec32 (svBitVec32* d, const svBitPackedArrRef s, int w);
void svGetLogicVec32 (svLogicVec32* d, const svLogicPackedArrRef s, int w);

/* Bit selects */

/* Packed arrays are assumed to be indexed n-1:0,
 where 0 is the index of least significant bit */

/* functions for bit select */

/* s=source, i=bit-index */
svBit svGetSelectBit(const svBitPackedArrRef s, int i);
svLogic svGetSelectLogic(const svLogicPackedArrRef s, int i);

/* d=destination, i=bit-index, s=scalar */
void svPutSelectBit(svBitPackedArrRef d, int i, svBit s);
void svPutSelectLogic(svLogicPackedArrRef d, int i, svLogic s);

/*
 * functions for part select
 *
 * a narrow (<=32 bits) part select is copied between
 * the implementation representation and a single chunk of
 * canonical representation
 * Normalized ranges and indexing [n-1:0] are used for both arrays:
 * the array in the implementation representation and the canonical array.
 *
 * s=source, d=destination, i=starting bit index, w=width
 * like for variable part selects; limitations: w <= 32
 *
 * In part select operations, the data is copied to or from the
 * canonical representation part ('chunk') designated by range [w-1:0]
 * and the implementation representation part designated by range [w+i-1:i].
 */
/* canonical <-- actual */
void svGetPartSelectBit(svBitVec32* d, const svBitPackedArrRef s, int i,
 int w);
svBitVec32 svGetBits(const svBitPackedArrRef s, int i, int w);
svBitVec32 svGet32Bits(const svBitPackedArrRef s, int i); // 32-bits
unsigned long long svGet64Bits(const svBitPackedArrRef s, int i); // 64-bits
void svGetPartSelectLogic(svLogicVec32* d, const svLogicPackedArrRef s, int i,
 int w);

/* actual <-- canonical */
void svPutPartSelectBit(svBitPackedArrRef d, const svBitVec32 s, int i, int w);
void svPutPartSelectLogic(svLogicPackedArrRef d, const svLogicVec32 s, int i,

```

LRM 277

```

 int w);

/* Array querying functions */
/* These functions are modelled upon the SystemVerilog array querying functions
 and use the same semantics*/
/* If the dimension is 0, then the query refers to the packed part (which is one-
 dimensional) of an array, and dimensions > 0 refer to the unpacked part of an
 array.*/

/* h= handle to open array, d=dimension */
int svLeft(const svOpenArrayHandle h, int d);
int svRight(const svOpenArrayHandle h, int d);
int svLow(const svOpenArrayHandle h, int d);
int svHigh(const svOpenArrayHandle h, int d);
int svIncrement(const svOpenArrayHandle h, int d);
int svLength(const svOpenArrayHandle h, int d);
int svDimensions(const svOpenArrayHandle h);

/* a pointer to the actual representation of the whole array of any type */
/* NULL if not in C layout */
void *svGetArrayPtr(const svOpenArrayHandle);

int svSizeOfArray(const svOpenArrayHandle); /* total size in bytes or 0 if not in C
 layout */

/* Return a pointer to an element of the array
 or NULL if index outside the range or null pointer */

void *svGetArrElemPtr(const svOpenArrayHandle, int indx1, ...);

 /* specialized versions for 1-, 2- and 3-dimensional arrays: */
void *svGetArrElemPtr1(const svOpenArrayHandle, int indx1);
void *svGetArrElemPtr2(const svOpenArrayHandle, int indx1, int indx2);
void *svGetArrElemPtr3(const svOpenArrayHandle, int indx1, int indx2, int indx3);

/* Functions for translation between simulator and canonical representations*/
/* These functions copy the whole packed array in either direction. The user is
 responsible for allocating an array in the canonical representation. */
/* s=source, d=destination */
/* actual <-- canonical */
void svPutBitArrElemVec32 (const svOpenArrayHandle d, const svBitVec32* s,
 int indx1, ...);
void svPutBitArrElem1Vec32(const svOpenArrayHandle d, const svBitVec32* s,
 int indx1);
void svPutBitArrElem2Vec32(const svOpenArrayHandle d, const svBitVec32* s,
 int indx1, int indx2);
void svPutBitArrElem3Vec32(const svOpenArrayHandle d, const svBitVec32* s,
 int indx1, int indx2, int indx3);

void svPutLogicArrElemVec32 (const svOpenArrayHandle d, const svLogicVec32* s,
 int indx1, ...);
void svPutLogicArrElem1Vec32(const svOpenArrayHandle d, const svLogicVec32* s,
 int indx1);
void svPutLogicArrElem2Vec32(const svOpenArrayHandle d, const svLogicVec32* s,
 int indx1, int indx2);
void svPutLogicArrElem3Vec32(const svOpenArrayHandle d, const svLogicVec32* s,
 int indx1, int indx2, int indx3);

/* canonical <-- actual */

```

```

void svGetBitArrElemVec32 (svBitVec32* d, const svOpenArrayHandle s,
 int indx1, ...);
void svGetBitArrElem1Vec32(svBitVec32* d, const svOpenArrayHandle s, int indx1);

void svGetBitArrElem2Vec32(svBitVec32* d, const svOpenArrayHandle s, int indx1,
 int indx2);
void svGetBitArrElem3Vec32(svBitVec32* d, const svOpenArrayHandle s,
 int indx1, int indx2, int indx3);

void svGetLogicArrElemVec32 (svLogicVec32* d, const svOpenArrayHandle s,
 int indx1, ...);
void svGetLogicArrElem1Vec32(svLogicVec32* d, const svOpenArrayHandle s,
 int indx1);
void svGetLogicArrElem2Vec32(svLogicVec32* d, const svOpenArrayHandle s,
 int indx1,
 int indx2);
void svGetLogicArrElem3Vec32(svLogicVec32* d, const svOpenArrayHandle s,
 int indx1, int indx2, int indx3);

svBit svGetBitArrElem (const svOpenArrayHandle s, int indx1, ...);
svBit svGetBitArrElem1(const svOpenArrayHandle s, int indx1);
svBit svGetBitArrElem2(const svOpenArrayHandle s, int indx1, int indx2);
svBit svGetBitArrElem3(const svOpenArrayHandle s, int indx1, int indx2,
 int indx3);

svLogic svGetLogicArrElem (const svOpenArrayHandle s, int indx1, ...);
svLogic svGetLogicArrElem1(const svOpenArrayHandle s, int indx1);
svLogic svGetLogicArrElem2(const svOpenArrayHandle s, int indx1, int indx2);
svLogic svGetLogicArrElem3(const svOpenArrayHandle s, int indx1, int indx2,
 int indx3);

void svPutLogicArrElem (const svOpenArrayHandle d, svLogic value, int indx1, ...);
void svPutLogicArrElem1(const svOpenArrayHandle d, svLogic value, int indx1);
void svPutLogicArrElem2(const svOpenArrayHandle d, svLogic value, int indx1,
 int indx2);
void svPutLogicArrElem3(const svOpenArrayHandle d, svLogic value, int indx1,
 int indx2, int indx3);

void svPutBitArrElem (const svOpenArrayHandle d, svBit value, int indx1, ...);
void svPutBitArrElem1(const svOpenArrayHandle d, svBit value, int indx1);
void svPutBitArrElem2(const svOpenArrayHandle d, svBit value, int indx1,
 int indx2);
void svPutBitArrElem3(const svOpenArrayHandle d, svBit value, int indx1,
 int indx2, int indx3);

/* Functions for working with DPI context functions */

/* Retrieve the active instance scope currently associated with the executing
 imported function.
 Unless a prior call to svSetScope has occurred, this is the scope of the
 function's declaration site, not call site.
 Returns NULL if called from C code that is *not* an imported function. */
svScope svGetScope();

/* Set context for subsequent export function execution.
 This function must be called before calling an export function, unless
 the export function is called while executing an extern function. In that
 case the export function shall inherit the scope of the surrounding extern
 function. This is known as the "default scope".

```

```

 The return is the previous active scope (as per svGetScope) */
svScope svSetScope(const svScope scope);

/* Gets the fully qualified name of a scope handle */
const char* svGetNameFromScope(const svScope);

/* Retrieve svScope to instance scope of an arbitrary function declaration.
 * (can be either module, program, interface, or generate scope)
 * The return value shall be NULL for unrecognized scope names.
 */
svScope svGetScopeFromName(const char* scopeName);

/* Store an arbitrary user data pointer for later retrieval by svGetUserData()
 * The userKey is generated by the user. It must be guaranteed by the user to
 * be unique from all other userKey's for all unique data storage requirements
 * It is recommended that the address of static functions or variables in the
 * user's C code be used as the userKey.
 * It is illegal to pass in NULL values for either the scope or userData
 * arguments. It is also an error to call svPutUserData() with an invalid
 * svScope. This function returns -1 for all error cases, 0 upon success. It is
 * suggested that userData values of 0 (NULL) not be used as otherwise it can
 * be impossible to discern error status returns when calling svGetUserData()
 */
int svPutUserData(const svScope scope, void *userKey, void* userData);

/* Retrieve an arbitrary user data pointer that was previously
 * stored by a call to svPutUserData(). See the comment above
 * svPutUserData() for an explanation of userKey, as well as
 * restrictions on NULL and illegal svScope and userKey values.
 * This function returns NULL for all error cases, 0 upon success.
 * This function also returns NULL in the event that a prior call
 * to svPutUserData() was never made.
 */
void* svGetUserData(const svScope scope, void* userKey);

/* Returns the file and line number in the SV code from which the extern call
 * was made. If this information available, returns TRUE and updates fileName
 * and lineNumber to the appropriate values. Behavior is unpredictable if
 * fileName or lineNumber are not appropriate pointers. If this information is
 * not available return FALSE and contents of fileName and lineNumber not
 * modified. Whether this information is available or not is implementation
 * specific. Note that the string provided (if any) is owned by the SV
 * implementation and is valid only until the next call to any SV function.
 * Applications must not modify this string or free it
 */
int svGetCallerInfo(char **fileName, int *lineNumber);

/*
 * Returns 1 if the current execution thread is in the disabled state.
 * Disable protocol must be adhered to if in the disabled state.
 */
int svIsDisabledState();

/*
 * Imported functions call this API function during disable processing to
 * acknowledge that they are correctly participating in the DPI disable protocol.
 * This function must be called before returning from an imported function that is
 * in the disabled state.

```

LRM 132

```
*/
void svAckDisabledState();
```

## F.2 Source-level compatibility include file svdpi\_src.h

```
/* macros for declaring variables to represent the SystemVerilog */
/* packed arrays of type bit or logic */
/* WIDTH= number of bits,NAME = name of a declared field/variable */
#define SV_BIT_PACKED_ARRAY(WIDTH,NAME)/* actual definition goes here */
#define SV_LOGIC_PACKED_ARRAY(WIDTH,NAME)/* actual definition goes here */
```



## Annex G

### Inclusion of Foreign Language Code

This annex describes common guidelines for the inclusion of Foreign Language Code into a SystemVerilog application. This intention of these guidelines is to enable the redistribution of C binaries in shared object form.

*Foreign Language Code* is functionality that is included into SystemVerilog using the DPI Interface. As a result, all statements of this annex apply only to code included using this interface; code included by using other interfaces (e.g., PLI or VPI) is outside the scope of this document. Due to the nature of the DPI Interface, most Foreign Language Code is usually be created from C or C++ source code, although nothing precludes the creation of appropriate object code from other languages. This annex adheres to this rule, it's content is independent from the actual language used.

In general, Foreign Language Code is provided in the form of object code compiled for the actual platform. The capability to include Foreign Language Code in object-code form shall be supported by all simulators as specified here. Overview

This annex defines how to:

- specify the location of the corresponding files within the file system
- specify the files to be loaded (in case of object code) or
- provide the object code (as a shared library or archive)

Although this annex defines guidelines for a common inclusion methodology, it requires multiple implementations (usually two) of the corresponding facilities. This takes into account that multiple users can have different viewpoints and different requirements on the inclusion of Foreign Language Code.

- A vendor that wants to provide his IP in form of Foreign Language Code often requires a self-contained method for the integration, which still permits an integration by a third party. This use-case is often covered by a bootstrap file approach.
- A project team that specifies a common, standard set of Foreign Language code, might change the code depending on technology, selected cells, back-annotation data, and other items. This-use case is often covered by a set of tool switches, although it might also use the bootstrap file approach.
- An user might want to switch between selections or provide additional code. This-use case is covered by providing a set of tool switches to define the corresponding information, although it might also use the bootstrap file approach.

NOTE—This annex defines a set of switch names to be used for a particular functionality. This is of informative nature; the actual naming of switches is not part of this standard. It might further not be possible to use certain character configurations in all operating systems or shells. Therefore any switch name defined within this document is a recommendation how to name a switch, but not a requirement of the language.

#### G.1 Location independence

All pathnames specified within this annex are intended to be location-independent, which is accomplished by using the switch `-sv_root`. It can receive a single directory pathname as the value, which is then prepended to any relative pathname that has been specified. In absence of this switch, or when processing relative filenames before any `-sv_root` specification, the current working directory of the user shall be used as the default value.

#### G.2 Object code inclusion

Compiled object code is required for cases where the compilation and linking of source code is fully handled by the user; thus, the created object code only need be loaded to integrate the Foreign Language Code into a SystemVerilog application. All SystemVerilog applications shall support the integration of Foreign Language

Code in object code form. Figure 7-1 depicts the inclusion of object code and its relations to the various steps involved in this integration process.

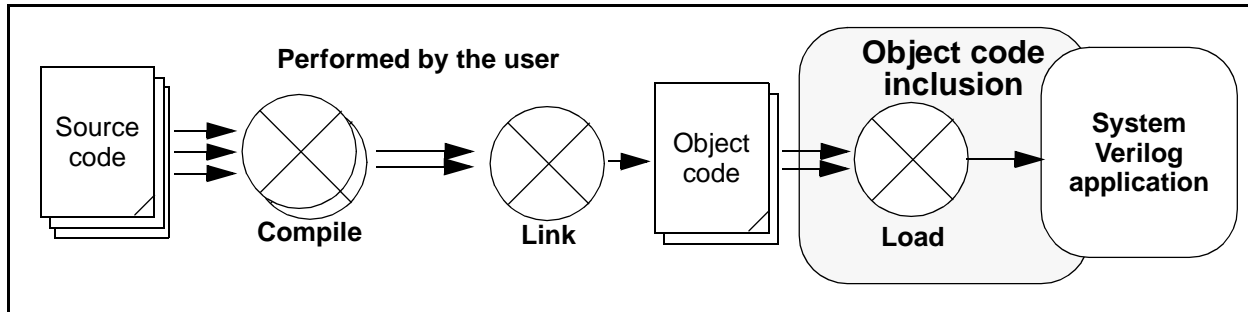

**Figure 7-1 — Inclusion of object code into a SystemVerilog application**

Compiled object code can be specified by one of the following two methods:

- 1) by an entry in a bootstrap file; see Annex G.2.1 for more details on this file and its content. Its location shall be specified with one instance of the switch `-sv_liblist pathname`. This switch can be used multiple times to define the usage of multiple bootstrap files.
- 2) by specifying the file with one instance of the switch `-sv_lib pathname_without_extension` (i.e., the filename shall be specified without the platform specific extension). The SystemVerilog application is responsible for appending the appropriate extension for the actual platform. This switch can be used multiple times to define multiple libraries holding object code.

Both methods shall be provided and made available concurrently, to permit any mixture of their usage. Every location can be an absolute pathname or a relative pathname, where the value of the switch `-sv_root` is used to identify an appropriate prefix for relative pathnames (see Annex G.1 for more details on forming pathnames).

The following conditions also apply.

- The compiled object code itself shall be provided in form of a shared library having the appropriate extension for the actual platform.

NOTE—Shared libraries use, for example, `.so` for Solaris and `.sl` for HP-UX; other operating systems might use different extensions. In any case, the SystemVerilog application needs to identify the appropriate extension.

- The provider of the compiled code is responsible for any external references specified within these objects. Appropriate data needs to be provided to resolve all open dependencies with the correct information.
- The provider of the compiled code shall avoid interferences with other software and ensure the appropriate software version is taken (e.g., in cases where two versions of the same library are referenced). Similar problems can arise when there are dependencies on the expected runtime environment in the compiled object code (e.g., in cases where C++ global objects or static initializers are used).
- The SystemVerilog application need only load object code within a shared library that is referenced by the SystemVerilog code or by registration functions; loading of additional functions included within a shared library can interfere with other parts.

In case of multiple occurrences of the same file (files having the same pathname or which can easily be identified as being identical; e.g., by comparing the inodes of the files to detect cases where links are used to refer the same file), the above order also identifies the precedence of loading; a file located by method 1) shall override files specified by method 2).

All compiled object code need to be loaded in the specification order similarly to the above scheme; first the content of the bootstrap file is processed starting with the first line, then the set of `-sv_lib` switches is processed in order of their occurrence. Any library shall only be loaded once.

### G.2.1 Bootstrap file

The object code bootstrap file has the following syntax.

- 1) The first line contains the string `#!SV_LIBRARIES`.
- 2) An arbitrary amount of entries follow, one entry per line, where every entry holds exactly one library location. Each entry consists only of the *pathname\_without\_extension* of the object code file to be loaded and can be surrounded by an arbitrary number of blanks; at least one blank shall precede the entry in the line. The value *pathname\_without\_extension* is equivalent to the value of the switch `-sv_lib`.
- 3) Any amount of comment lines can be interspersed between the entry lines; a comment line starts with the character `#` after an arbitrary (including zero) amount of blanks and is terminated with a newline.

### G.2.2 Examples

- 1) If the pathname root has been set by the switch `-sv_root` to `/home/user` and the following object files need to be included:

```
/home/user/myclibs/lib1.so
/home/user/myclibs/lib3.so
/home/user/proj1/clibs/lib4.so
/home/user/proj3/clibs/lib2.so
```

then use either of the methods in Example 7-1. Both methods are equivalent.

```
#!SV_LIBRARIES
myclibs/lib1
myclibs/lib3
proj1/clibs/lib4
proj3/clibs/lib2
```

**Bootstrap file method**

```
...
-sv_lib myclibs/lib1
-sv_lib myclibs/lib3
-sv_lib proj1/clibs/lib4
-sv_lib proj3/clibs/lib2
...
```

**Switch list method**

*Example 7-1 — Using a simple bootstrap file or a switch list*

- 2) If the current working directory is `/home/user`, using the series of switches shown in Example 7-2 (left column) result in loading the following files (right column).

```
-sv_lib svLibrary1
-sv_lib svLibrary2
-sv_root /home/project2/shared_code
-sv_lib svLibrary3
-sv_root /home/project3/code
-sv_lib svLibrary4
```

**Switches**

```
/home/user/svLibrary1.so
/home/user/svLibrary2.so

/home/project2/shared_code/svLibrary3.so

/home/project3/code/svLibrary4.so
```

**Files**

*Example 7-2 — Using a combination of `-sv_lib` and `-sv_root` switches*

3) Further, using the set of switches and contents of bootstrap files shown in Example 7-3:

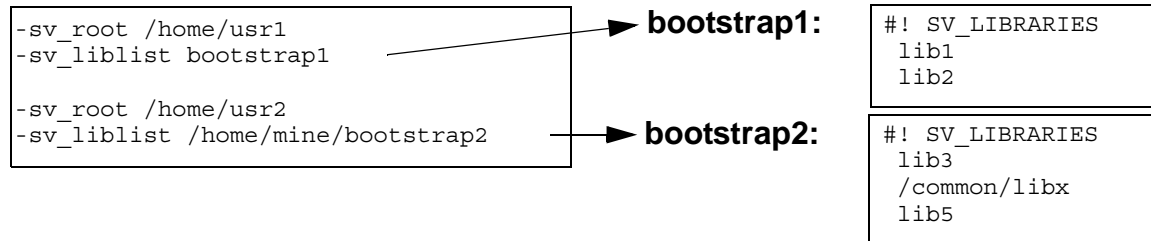

*Example 7-3 — Mixing -sv\_root and bootstrap files*

results in loading the following files:

```
/home/usr1/lib1.ext
/home/usr1/lib2.ext
/home/usr2/lib3.ext
/common/libx.ext
/home/usr2/lib5.ext
```

where *ext* stands for the actual extension of the corresponding file.

## Annex H

# SystemVerilog Concurrent Assertions Semantics

### H.1 Introduction

This appendix presents a formal semantics for SystemVerilog concurrent assertions. Immediate assertions and coverage statements are not discussed here. Throughout this appendix, “assertion” is used to mean “concurrent assertion”. The semantics is defined by a relation that determines when a finite or infinite word (i.e., trace) satisfies an assertion. Intuitively, such a word represents a sequence of valuations of SystemVerilog variables sampled at the finest relevant granularity of time (e.g., at the granularity of simulator cycles). The process by which such words are produced is closely related to the SystemVerilog scheduling semantics and is not defined here. In this appendix, words are assumed to be sequences of elements, each element being either a set of atomic propositions or one of two special symbols used as placeholders when extending finite words. The atomic propositions are not further defined. The meaning of satisfaction of a SystemVerilog boolean expression by a set of atomic propositions is assumed to be understood.

The semantics is based on an abstract syntax for SystemVerilog assertions. There are several advantages to using the abstract syntax rather than the full SystemVerilog Assertions BNF.

- 1) The abstract syntax facilitates separation of derived operators from basic operators. The satisfaction relation is defined explicitly only for assertions built from basic operators.
- 2) The abstract syntax avoids reliance on operator precedence, associativity, and auxiliary rules for resolving syntactic and semantic ambiguities.
- 3) The abstract syntax simplifies the assertion language by eliminating some features that tend to encumber the definition of the formal semantics.
  - a) The abstract syntax eliminates local variable declarations. The semantics of local variables is written with implicit types.
  - b) The abstract syntax eliminates instantiation of sequences and properties. The semantics of an assertion with an instance of a sequence or non-recursive property is the same as the semantics of a related assertion obtained by replacing the sequence or non-recursive property instance with an explicitly written sequence or property. The explicit sequence or property is obtained from the body of the associated declaration by substituting actual arguments for formal arguments. A separate section defines the semantics of instances of recursive properties in terms of the semantics of instances of non-recursive properties. LRM 130
  - c) The abstract syntax does not allow implicit clocks. Clocking event controls must be applied explicitly in the abstract syntax.
  - d) The abstract syntax does not allow explicit procedural enabling conditions for assertions. Procedural enabling conditions are utilized in the semantics definition (see Subsection 3.3.1), but the method for extracting such conditions is not defined in this appendix.
- 4) The abstract syntax eliminates the distinction between *property\_expr* and *property\_spec* from the full BNF. Without the distinction, `disable iff` is a general, nestable property-building operator, while in the full BNF `disable iff` can be attached only at the top level of a property. Semantically, there is no need for this restriction on the placement of `disable iff`. The abstract syntax thus eliminates an unnecessary semantic layer while maintaining the simple inductive form for the definition of the semantics of properties. As a result, semantics are given for some properties that do not correspond to forms from the full BNF, but this does not degrade the definitions for the properties that do correspond to forms from the full BNF. LRM 130

In order to use this appendix to determine the semantics of a SystemVerilog assertion, the assertion must first be transformed into an enabling condition together with an assertion in the abstract syntax. For assertions that LRM 130

do not involve recursive properties, this transformation involves eliminating sequence and non-recursive property instances by substitution, eliminating local variable declarations, introducing parentheses, determining the enabling condition, determining implicit or inferred clocking event controls, and eliminating redundant clocking event controls. For example, the following SystemVerilog assertion

LRM 131

```
sequence s(x,y); x ##1 y; endsequence
sequence t(z); @(c) z[*1:2] ##1 B; endsequence
always @(c) if (b) assert property (s(A,B) | => t(A));
```

is transformed into the enabling condition “b” together with the assertion

```
always @(c) assert property ((A ##1 B) | => (A[*1:2] ##1 B))
```

in the abstract syntax.

If the SystemVerilog assertion involves instances of recursive properties, then the transformation replaces these instances with placeholder functions of the actual arguments. The semantics of an instance of a recursive property is defined in terms of associated non-recursive properties in Section H.5. Once the semantics of the recursive property instances are understood, the placeholder functions are treated as properties with these semantics. Then the ordinary definitions can be applied to the transformed assertion in the abstract syntax together with placeholder functions.

LRM 130

## H.2 Abstract Syntax

### H.2.1 Abstract grammars

In the following abstract grammars, *b* denotes a boolean expression, *v* denotes a local variable name, and *e* denotes an expression.

The abstract grammar for unlocked sequences is *R*

```
R ::= b // "boolean expression" form
| (1, v = e) // "local variable sampling" form
| (R) // "parenthesis" form
| (R ##1 R) // "concatenation" form
| (R ##0 R) // "fusion" form
| (R or R) // "or" form
| (R intersect R) // "intersect" form
| first_match (R) // "first match" form
| R [*0] // "null repetition" form
| R [*1:$] // "unbounded repetition" form
```

The abstract grammar for clocked sequences is

```
S ::= @(b) R // "clock" form
| (S) // "parenthesized" form
| (S ## S) // "concatenation" form
```

LRM 211  
LRM 238

The abstract grammar for unlocked properties is

```
P ::= R // "sequence" form
| (P) // "parenthesis" form
| not P // "negation" form
| (P or P) // "or" form
| (P and P) // "and" form
| (R |-> P) // "implication" form
| disable iff (b) P // "reset" form
```

LRM 131

JH3

JH4

Each instance of *R* in this production must be a non-degenerate unlocked sequence. In the “sequence” form, *R* must not be tightly satisfied by the empty word. See H.3.2 and H.3.5 for the definitions of non-degeneracy and tight satisfaction.

LRM 280

JH5

SVA 1

The abstract grammar for clocked properties is

```

Q ::= @(b) P // "clock" form
 | S // "sequence" form
 | (Q) // "parenthesis" form
 | not Q // "negation" form
 | (Q or Q) // "or" form
 | (Q and Q) // "and" form
 | (S |-> Q) // "implication" form
 | disable iff (b) Q // "reset" form

```

LRM 131

Each instance of  $S$  in this production must be a non-degenerate clocked sequence. In the “sequence” form,  $S$  must not be tightly satisfied by the empty word. See H.3.2 and H.3.5 for the definitions of non-degeneracy and tight satisfaction.

LRM 280

JH6

SVA 2

The abstract grammar for assertions is

```

A ::= always assert property Q // "always" form
 | always @(b) assert property P // "always with clock" form
 | initial assert property Q // "initial" form
 | initial @(b) assert property P // "initial with clock" form

```

JH7

## H.2.2 Notations

Throughout the sequel, the following notational conventions will be used:  $b, c$  denote boolean expressions;  $v$  denotes a local variable name;  $e$  denotes an expression;  $R, R_1, R_2$  denote unclocked sequences;  $S, S_1, S_2$  denote clocked sequences;  $P, P_1, P_2$  denotes ~~an~~ unclocked **property properties**;  $Q$  denotes a clocked property;  $A$  denotes an assertion;  $i, j, k, m, n$  denote non-negative integer constants.

LRM 131

JH8

JH9

LRM 260

## H.2.3 Derived forms

Internal parentheses are omitted in compositions of the (associative) operators **##1** and **or**.

### H.2.3.1 Derived non-overlapping implication operator

- $(R_1 | => P) \equiv ((R_1 \##1 1) |-> P)$ .
- $(S_1 | => Q) \equiv ((S_1 \##1 @(1) 1) |-> Q)$ .

LRM 131

LRM 211

### H.2.3.2 Derived consecutive repetition operators

- Let  $m > 0$ .  $R[*m] \equiv (R \##1 R \##1 \dots \##1 R)$  //  $m$  copies of  $R$ .
- $R[*0:\$] \equiv (R[*0] \text{ or } R[*1:\$])$ .
- Let  $m \leq n$ .  $R[*m:n] \equiv (R[*m] \text{ or } R[*m+1] \text{ or } \dots \text{ or } R[*n])$ .
- Let  $m > 1$ .  $R[*m:\$] \equiv (R[*m-1] \##1 R[*1:\$])$ .

### H.2.3.3 Derived delay and concatenation operators

Let  $m \leq n$ .

- $(\##[m:n] R) \equiv (1[*m:n] \##1 R)$ .
- $(\##[m:\$] R) \equiv (1[*m:\$] \##1 R)$ .
- $(\##m R) \equiv (1[*m] \##1 R)$ .
- Let  $m > 0$ .  $(R_1 \##[m:n] R_2) \equiv (R_1 \##1 1[*m-1:n-1] \##1 R_2)$ .

- Let  $m > 0$ .  $(R_1 \ \#\#[m:\$] \ R_2) \equiv (R_1 \ \#\#1 \ 1[*m-1:\$] \ \#\#1 \ R_2)$ .
- Let  $m > 1$ .  $(R_1 \ \#\#m \ R_2) \equiv (R_1 \ \#\#1 \ 1[*m-1] \ \#\#1 \ R_2)$ .
- $(R_1 \ \#\#[0:0] \ R_2) \equiv (R_1 \ \#\#0 \ R_2)$ .
- Let  $n > 0$ .  $(R_1 \ \#\#[0:n] \ R_2) \equiv ((R_1 \ \#\#0 \ R_2) \ \text{or} \ (R_1 \ \#\#[1:n] \ R_2))$ .
- $(R_1 \ \#\#[0:\$] \ R_2) \equiv ((R_1 \ \#\#0 \ R_2) \ \text{or} \ (R_1 \ \#\#[1:\$] \ R_2))$ .

### H.2.3.4 Derived non-consecutive repetition operators

Let  $m \leq n$ .

- $b \ [*->m:n] \equiv (!b \ [*0:\$] \ \#\#1 \ b) \ [*m:n]$ .
- $b \ [*->m:\$] \equiv (!b \ [*0:\$] \ \#\#1 \ b) \ [*m:\$]$ .
- $b \ [*->m] \equiv (!b \ [*0:\$] \ \#\#1 \ b) \ [*m]$ .
- $b \ [*=m:n] \equiv (b \ [*->m:n] \ \#\#1 \ !b \ [*0:\$])$ .
- $b \ [*=m:\$] \equiv (b \ [*->m:\$] \ \#\#1 \ !b \ [*0:\$])$ .
- $b \ [*=m] \equiv (b \ [*->m] \ \#\#1 \ !b \ [*0:\$])$ .

LRM 209

### H.2.3.5 Other derived operators

- $(R_1 \ \text{and} \ R_2) \equiv (((R_1 \ \#\#1 \ 1[*0:\$]) \ \text{intersect} \ R_2) \ \text{or} \ (R_1 \ \text{intersect} \ (R_2 \ \#\#1 \ 1[*0:\$])))$ .
- $(R_1 \ \text{within} \ R_2) \equiv ((1[*0:\$] \ \#\#1 \ R_1 \ \#\#1 \ 1[*0:\$]) \ \text{intersect} \ R_2)$ .
- $(b \ \text{throughout} \ R) \equiv ((b \ [*0:\$]) \ \text{intersect} \ R)$ .
- $(R, \ v = e) \equiv (R \ \#\#0 \ (1, \ v = e))$ .
- $(R, \ v_1 = e_1, \dots, v_k = e_k) \equiv ((R, \ v_1 = e_1) \ \#\#0 \ (1, \ v_2 = e_2, \dots, v_k = e_k)) \ \text{for} \ k > 1$
- $(\text{if}(b) \ P) \equiv (b \ |-> \ P)$
- $(\text{if}(b) \ P_1 \ \text{else} \ P_2) \equiv ((b \ |-> \ P_1) \ \text{and} \ (!b \ |-> \ P_2))$

LRM 129

SVA 3

LRM 131

## H.3 Semantics

Let  $\mathbf{P}$  be the set of atomic propositions.

The semantics of assertions and properties is defined via a relation of satisfaction by empty, finite, and infinite words over the alphabet  $\Sigma = 2^{\mathbf{P}} \cup \{\top, \perp\}$ . Such a word is an empty, finite, or infinite sequence of elements of  $\Sigma$ . The number of elements in the sequence is called the *length* of the word, and the length of word  $w$  is denoted  $|w|$ . Note that  $|w|$  is either a non-negative integer or infinity.

SVA 4

The sequence elements of a word are called its *letters* and are assumed to be indexed consecutively beginning at zero. If  $|w| > 0$ , then the first letter of  $w$  is denoted  $w^0$ ; if  $|w| > 1$ , then the second letter of  $w$  is denoted  $w^1$ ; and so forth.  $w^{i..}$  denotes the word obtained from  $w$  by deleting its first  $i$  letters. If  $i < |w|$ , then  $w^{i..} = w^i w^{i+1} \dots$ . If  $i \geq |w|$ , then  $w^{i..}$  is empty.

If  $i \leq j$ , then  $w^{i..j}$  denotes the finite word obtained from  $w$  by deleting its first  $i$  letters and also deleting all letters after its  $(j + 1)$ st. If  $i \leq j < |w|$ , then  $w^{i..j} = w^i w^{i+1} \dots w^j$ .

If  $w$  is a word over  $\Sigma$ , define  $\bar{w}$  to be the word obtained from  $w$  by interchanging  $\top$  with  $\perp$ . More precisely,

SVA 5,6,7



$\bar{w}^i = \top$  if  $w^i = \perp$ ;  $\bar{w}^i = \perp$  if  $w^i = \top$ ; and  $\bar{w}^i = w^i$  if  $w^i$  is an element in  $2^P$ .

The semantics of clocked sequences and properties is defined in terms of the semantics of unclocked sequences and properties. See the subsection on rewrite rules for clocks below.

It is assumed that the satisfaction relation  $\zeta \models b$  is defined for elements  $\zeta$  in  $2^P$  and boolean expressions  $b$ . For any boolean expression  $b$ , define

$\top \models b$  and  $\perp \not\models b$ .

SVA 8

### H.3.1 Rewrite rules for clocks

The semantics of clocked sequences and properties is defined in terms of the semantics of unclocked sequences and properties. The following rewrite rules define the transformation of a clocked sequence or property into an unclocked version that is equivalent for the purposes of defining the satisfaction relation. In this transformation, it is required that the conditions in event controls not be dependent upon any local variables.

- $@(c) b \longmapsto (!c [*0:\$] \##1 c \& b)$ .
- $@(c) (1, v = e) \longmapsto (@(c) 1 \##0 (1, v = e))$ .
- $@(c) (P) \longmapsto (@(c) P)$ .
- $@(c) (R_1 \##1 R_2) \longmapsto (@(c) R_1 \##1 @(c) R_2)$ .
- $@(c) (R_1 \##0 R_2) \longmapsto (@(c) R_1 \##0 @(c) R_2)$ .
- $@(c) (R_1 \text{ or } R_2) \longmapsto (@(c) R_1 \text{ or } @(c) R_2)$ .
- $@(c) (R_1 \text{ intersect } R_2) \longmapsto (@(c) R_1 \text{ intersect } @(c) R_2)$ .
- $@(c) \text{ first\_match } (R) \longmapsto \text{ first\_match } (@(c) R)$ .
- $@(c) R [*0] \longmapsto (@(c) R) [*0]$ .
- $@(c) R [*1:\$] \longmapsto (@(c) R) [*1:\$]$ .
- $@(c) \text{ disable iff } (b) P \longmapsto \text{ disable iff } (b) @(c) P$ .
- $@(c) \text{ not } P \longmapsto \text{ not } @(c) P$ .
- $@(c) (R \rightarrow P) \longmapsto (@(c) R \rightarrow @(c) P)$ .
- $\color{red}{\neg (S_1 \## S_2)} \longmapsto \color{red}{\neg (S_1 \##1 S_2)}$ .
- $@(c) (P_1 \text{ or } P_2) \longmapsto (@(c) P_1 \text{ or } @(c) P_2)$ .
- $@(c) (P_1 \text{ and } P_2) \longmapsto (@(c) P_1 \text{ and } @(c) P_2)$ .

LRM 131

JH10

LRM 131

LRM 131

LRM 131

LRM 211

LRM 131

JH11

### H.3.2 Tight satisfaction without local variables

Tight satisfaction is denoted by  $\models$ . For unclocked sequences without local variables, tight satisfaction is defined as follows.  $w, x, y, z$  denote finite words over  $\Sigma$ .

- $w \models b$  iff  $|w| = 1$  and  $w^0 \models b$ .
- $w \models (R)$  iff  $w \models R$ .
- $w \models (R_1 \##1 R_2)$  iff there exist  $x, y$  such that  $w = xy$  and  $x \models R_1$  and  $y \models R_2$ .
- $w \models (R_1 \##0 R_2)$  iff there exist  $x, y, z$  such that  $w = xyz$  and  $|y| = 1$ , and  $xy \models R_1$  and  $yz \models R_2$ .
- $w \models (R_1 \text{ or } R_2)$  iff either  $w \models R_1$  or  $w \models R_2$ .

SVA 9

- $w \models (R_1 \text{ intersect } R_2)$  iff both  $w \models R_1$  and  $w \models R_2$ .
- $w \models \text{first\_match}(R)$  iff both
  - $w \models R$  and JH12
  - if there exist  $x, y$  such that  $w = xy$  and  $\bar{x} \models R$ , then  $y$  is empty. SVA 10
- $w \models R[*0]$  iff  $|w| = 0$ .
- $w \models R[*1:\$]$  iff there exist words  $w_1, w_2, \dots, w_j$  ( $j \geq 1$ ) such that  $w = w_1w_2\dots w_j$  and for every  $i$  such that  $1 \leq i \leq j$ ,  $w_i \models R$ .

If  $S$  is a clocked sequence, then  $w \models S$  iff  $w \models S'$ , where  $S'$  is the unlocked sequence that results from  $S$  by applying the rewrite rules.

An unlocked sequence  $R$  is *non-degenerate* iff there exists a non-empty finite word  $w$  over  $\Sigma$  such that  $w \models R$ . A clocked sequence  $S$  is *non-degenerate* iff the unlocked sequence  $S'$  that results from  $S$  by applying the rewrite rules is non-degenerate. SVA 11

### H.3.3 Satisfaction without local variables

#### H.3.3.1 Neutral satisfaction SVA 12

$w$  denotes a non-empty finite or infinite word over  $\Sigma$ . Assume that all properties, sequences, and unlocked property fragments do not involve local variables. SVA 13

Neutral satisfaction of assertions: SVA 14

For the definition of neutral satisfaction of assertions,  $b$  denotes the boolean expression representing the enabling condition for the assertion. Intuitively,  $b$  is derived from the conditions in the context of a procedural assertion, while  $b$  is “1” for a declarative assertion. SVA 15

- $w, b \models \text{always } @(c) \text{ assert property } P$  iff for every  $0 \leq i < |w|$  such that  $\bar{w}^i \models c$  and  $\overline{\{w\}}^i \models b$ ,  $w^{i..} \models @(c) P$ . JH13
- $w, b \models \text{always assert property } Q$  iff for every  $0 \leq i < |w|$ , if  $\bar{w}^i \models b$  then  $w^{i..} \models Q$ . LRM 260
- $w, b \models \text{initial } @(c) \text{ assert property } P$  iff for every  $0 \leq i < |w|$  such that  $\bar{w}^{0,i} \models !c[*0:\$] \#\#1 c$  and  $\bar{w}^i \models b$ ,  $w^{i..} \models @(c) P$ . SVA 17
- $w, b \models \text{initial assert property } Q$  iff (if  $\bar{w}^0 \models b$  then  $w \models Q$ ). SVA 18

Neutral satisfaction of properties: JH14

- $w \models (P)$  iff  $w \models P$ . SVA 19
- $w \models Q$  iff  $w \models Q'$ , where  $Q'$  is the unlocked property that results from  $Q$  by applying the rewrite rules. LRM 131
- $w \models \text{disable iff } (b) P$  iff either  $w \models P$  or there exists  $0 \leq k < |w|$  such that  $w^k \models b$  and  $w^{0,k-1} \overline{\top}^\omega \models P$ . Here,  $w^{0,-1}$  denotes the empty word. SVA 20
- $w \models \text{not } P$  iff  $\bar{w} \not\models P$ . JH15
- $w \models R$  iff there exists  $0 \leq j < |w|$  such that  $w^{0,j} \models R$ . LRM 131
- $w \models (R \mid \rightarrow P)$  iff for every  $0 \leq j < |w|$  such that  $\bar{w}^{0,j} \models R$ ,  $w^{j..} \models P$ . SVA 21
- $w \models (P_1 \text{ or } P_2)$  iff  $w \models P_1$  or  $w \models P_2$ . SVA 22
- $w \models (P_1 \text{ and } P_2)$  iff  $w \models P_1$  and  $w \models P_2$ . LRM 131

Remark: Since  $w$  is non-empty, it can be proved that  $w \models \text{not } b$  iff  $w \models !b$ . LRM 131

### H.3.3.2 Weak and strong satisfaction by finite words

SVA 23

This subsection defines weak and strong satisfaction, denoted  $\models^-$  and  $\models^+$  (respectively) of an assertion  $A$  by a finite (possibly empty) word  $w$  over  $\Sigma$ . These relations are defined in terms of the relation of neutral satisfaction by infinite words as follows:

SVA 24

SVA 25

JH17

- $w \models^- A$  iff  $w \uparrow^\omega \models A$ .
- $w \models^+ A$  iff  $w \perp^\omega \models A$ .

A tool checking for satisfaction of  $A$  by the finite word  $w$  should return:

- “holds strongly” if  $w \models^+ A$ .
- “fails” if  $w \not\models^- A$ .
- “pending” or “holds weakly” otherwise.

JH18

### H.3.4 Local variable flow

SVA 26

This subsection defines inductively how local variable names flow through unlocked sequences. Below, “ $\cup$ ” denotes set union, “ $\cap$ ” denotes set intersection, “ $-$ ” denotes set difference, and “ $\{\}$ ” denotes the empty set.

The function “*sample*” takes a sequence as input and returns a set of local variable names as output. Intuitively, this function returns the set of local variable names that are sampled (i.e., assigned) in the sequence.

JH19

The function “*block*” takes a sequence as input and returns a set of local variable names as output. Intuitively, this function returns the set of local variable names that are blocked from flowing out of the sequence.

The function “*flow*” takes a set  $X$  of local variable names and a sequence as input and returns a set of local variable names as output. Intuitively, this function returns the set of local variable names that flow out of the sequence given the set  $X$  of local variable names that flow into the sequence.

The function “*sample*” is defined by

- $sample(b) = \{\}$ .
- $sample((1, v = e)) = \{v\}$ .
- $sample((R)) = sample(R)$ .
- $sample((R_1 \## 1 R_2)) = sample(R_1) \cup sample(R_2)$ .
- $sample((R_1 \## 0 R_2)) = sample(R_1) \cup sample(R_2)$ .
- $sample((R_1 \text{ or } R_2)) = sample(R_1) \cup sample(R_2)$ .
- $sample((R_1 \text{ intersect } R_2)) = sample(R_1) \cup sample(R_2)$ .
- $sample(\text{first\_match}(R)) = sample(R)$ .
- $sample(R[*0]) = \{\}$ .
- $sample(R[*1:\$]) = sample(R)$ .

The function “*block*” is defined by

- $block(b) = \{\}$ .
- $block((1, v = e)) = \{\}$ .
- $block((R)) = block(R)$ .

- $block((R_1 \ \#\#1 \ R_2)) = (block(R_1) - flow(\{\}, R_2)) \cup block(R_2)$ .
- $block((R_1 \ \#\#0 \ R_2)) = (block(R_1) - flow(\{\}, R_2)) \cup block(R_2)$ .
- $block((R_1 \ or \ R_2)) = block(R_1) \cup block(R_2)$ .
- $block((R_1 \ intersect \ R_2)) = block(R_1) \cup block(R_2) \cup (sample(R_1) \cap sample(R_2))$ .
- $block(first\_match(R)) = block(R)$ .
- $block(R[*0]) = \{\}$ .
- $block(R[*1:\$]) = block(R)$ .

The function “flow” is defined by

- $flow(X, b) = X$ .
- $flow(X, (1, v = e)) = X \cup \{v\}$ .
- $flow(X, (R)) = flow(X, R)$ .
- $flow(X, (R_1 \ \#\#1 \ R_2)) = flow(flow(X, R_1), R_2)$ .
- $flow(X, (R_1 \ \#\#0 \ R_2)) = flow(flow(X, R_1), R_2)$ .
- $flow(X, (R_1 \ or \ R_2)) = flow(X, R_1) \cap flow(X, R_2)$ .
- $flow(X, (R_1 \ intersect \ R_2)) = (flow(X, R_1) \cup flow(X, R_2)) - block((R_1 \ intersect \ R_2))$ .
- $flow(X, first\_match(R)) = flow(X, R)$ .
- $flow(X, R[*0]) = X$ .
- $flow(X, R[*1:\$]) = flow(X, R)$ .

Remark: It can be proved that  $flow(X, R) = (X \cup flow(\{\}, R)) - block(R)$ . It follows that  $flow(\{\}, R)$  and  $block(R)$  are disjoint. It can also be proved that  $flow(\{\}, R)$  is a subset of  $sample(R)$ .

### H.3.5 Tight satisfaction with local variables

SVA 27

A *local variable context* is a function that assigns values to local variable names. If  $L$  is a local variable context, then  $dom(L)$  denotes the set of local variable names that are in the domain of  $L$ . If  $D \subseteq dom(L)$ , then  $L_D$  means the local variable context obtained from  $L$  by restricting its domain to  $D$ .

In the presence of local variables, tight satisfaction is a four-way relation defining when a finite word  $w$  over the alphabet  $\Sigma$  together with an input local variable context  $L_0$  satisfies an unclocked sequence  $R$  and yields an output local variable context  $L_1$ . This relation is denoted

$$w, L_0, L_1 \models R.$$

and is defined below. It can be proved that the definition guarantees that  $w, L_0, L_1 \models R$  implies  $dom(L_1) = flow(dom(L_0), R)$ .

- $w, L_0, L_1 \models (1, v = e)$  iff  $|w| = 1$  and  $w^0 \models 1$  and  $L_1 = \{(v, e[L_0, w^0])\} \cup L_{0|D}$ , where  $e[L_0, w^0]$  denotes the value obtained from  $e$  by evaluating first according to  $L_0$  and second according to  $w^0$  and  $D = dom(L_0) - \{v\}$ . In case  $w^0 \in \{\top, \perp\}$ ,  $e[L_0, \top]$  and  $e[L_0, \perp]$  can be any constant values of the type of  $e$ .
- $w, L_0, L_1 \models b$  iff  $|w| = 1$  and  $w^0 \models b[L_0]$  and  $L_1 = L_0$ . Here  $b[L_0]$  denotes the expression obtained from  $b$  by substituting values from  $L_0$ .
- $w, L_0, L_1 \models (R)$  iff  $w, L_0, L_1 \models R$ .

JH20

LRM 260

JH21

SVA 28

- $w, L_0, L_1 \models (R_1 \ \#\#1 \ R_2)$  iff there exist  $x, y, L'$  such that  $w = xy$  and  $x, L_0, L' \models R_1$  and  $y, L', L_1 \models R_2$ .
- $w, L_0, L_1 \models (R_1 \ \#\#0 \ R_2)$  iff there exist  $x, y, z, L'$  such that  $w = xyz$  and  $|y| = 1$ , and  $xy, L_0, L' \models R_1$  and  $yz, L', L_1 \models R_2$ .
- $w, L_0, L_1 \models (R_1 \ \text{or} \ R_2)$  iff there exists  $L'$  such that both of the following hold:

- either  $w, L_0, L' \models R_1$  or  $w, L_0, L' \models R_2$ , and
- $L_1 = L'|_D$ , where  $D = \text{flow}(\text{dom}(L_0), (R_1 \ \text{or} \ R_2))$ .

JH23

- $w, L_0, L_1 \models (R_1 \ \text{intersect} \ R_2)$  iff there exist  $L', L''$  such that  $w, L_0, L' \models R_1$  and  $w, L_0, L'' \models R_2$  and  $L_1 = L'|_D \cup L''|_D$ , where

$$D' = \text{flow}(\text{dom}(L_0), R_1) - (\text{block}((R_1 \ \text{intersect} \ R_2)) \cup \text{sample}(R_2))$$

$$D'' = \text{flow}(\text{dom}(L_0), R_2) - (\text{block}((R_1 \ \text{intersect} \ R_2)) \cup \text{sample}(R_1))$$

Remark: It can be proved that if  $w, L_0, L' \models R_1$  and  $w, L_0, L'' \models R_2$ , then  $L'|_D \cup L''|_D$  is a function.

- $w, L_0, L_1 \models \text{first\_match}(R)$  iff both
  - $w, L_0, L_1 \models R$  and
  - if there exist  $x, y, L'$  such that  $w = xy$  and  $\bar{x}, L_0, L' \models R$ , then  $y$  is empty.
- $w, L_0, L_1 \models R[*0]$  iff  $|w| = 0$  and  $L_1 = L_0$ .
- $w, L_0, L_1 \models R[*1:\$]$  iff there exist  $L_{(0)} = L_0, w_1, L_{(1)}, w_2, L_{(2)}, \dots, w_j, L_{(j)} = L_1$  ( $j \geq 1$ ) such that  $w = w_1 w_2 \dots w_j$  and for every  $i$  such that  $1 \leq i \leq j$ ,  $w_i, L_{(i-1)}, L_{(i)} \models R$ .

JH24

SVA 29

If  $S$  is a clocked sequence, then  $w, L_0, L_1 \models S$  iff  $w, L_0, L_1 \models S'$ , where  $S'$  is the unclocked sequence that results from  $S$  by applying the rewrite rules.

An unclocked sequence  $R$  is *non-degenerate* iff there exist a non-empty finite word  $w$  over  $\Sigma$  and local variable contexts  $L_0, L_1$  such that  $w, L_0, L_1 \models R$ . A clocked sequence  $S$  is *non-degenerate* iff the unclocked sequence  $S'$  that results from  $S$  by applying the rewrite rules is non-degenerate.

SVA 30

### H.3.6 Satisfaction with local variables

SVA 31

#### H.3.6.1 Neutral satisfaction

SVA 32,33

$w$  denotes a non-empty finite or infinite word over  $\Sigma$ .  $L_0, L_1$  denote local variable contexts.

SVA 34

The rules defining neutral satisfaction of an assertion are identical to those without local variables, but with the understanding that the underlying properties can have local variables.

SVA 35

JH25

Neutral satisfaction of properties:

SVA 36

- $w \models Q$  iff  $w, \{\} \models Q$ .
- $w, L_0 \models Q$  iff  $w, L_0 \models Q'$ , where  $Q'$  is the unclocked property that results from  $Q$  by applying the rewrite rules.
- $w, L_0 \models \text{disable iff}(b) P$  iff either  $w, L_0 \models P$  or there exists  $0 \leq k < |w|$  such that  $w^k \models b[L_0]$  and  $w^{0, k-1} \top^\omega, L_0 \models P$ . Here,  $w^{0, -1}$  denotes the empty word.
- $w, L_0 \models \text{not} P$  iff  $\bar{w}, L_0 \not\models P$ .
- $w, L_0 \models R$  iff there exist  $0 \leq j < |w|$  and  $L_1$  such that  $w^{0, j}, L_0, L_1 \models R$ .
- $w, L_0 \models (R \mid \rightarrow P)$  iff for every  $0 \leq j < |w|$  and  $L_1$  such that  $\bar{w}^{0, j}, L_0, L_1 \models R, w^{j, \cdot}, L_1 \models P$ .

SVA 37

SVA 38

SVA 39

LRM 131

SVA 40

SVA 41

LRM 131

- $w, L_0 \models (P)$  iff  $w, L_0 \models P$ .
- $w, L_0 \models (P_1 \text{ or } P_2)$  iff  $w, L_0 \models P_1$  or  $w, L_0 \models P_2$ .
- $w, L_0 \models (P_1 \text{ and } P_2)$  iff  $w, L_0 \models P_1$  and  $w, L_0 \models P_2$ .

LRM 131

LRM 260

### H.3.6.2 Weak and strong satisfaction by finite words

SVA 42

The definition is identical to that without local variables, but with the understanding that the underlying properties can have local variables.

## H.4 Extended Expressions

This section describes the semantics of several constructs that are used like expressions, but whose meaning at a point in a word can depend both on the letter at that point and on previous letters in the word. By abuse of notation, the meanings of these extended expressions are defined for letters denoted “ $w^j$ ” even though they depend also on letters  $w^i$  for  $i \leq j$ . The reason for this abuse is to make clear the way these definitions should be used in combination with those in preceding sections.

### H.4.1 Extended booleans

LRM 131

SVA 43

JH26

SVA 44

SVA 153

SVA 45

LRM 128

LRM 128

SVA 46

LRM 209

SVA 47

SVA 48

$w$  denotes a non-empty finite or infinite word over  $\Sigma$ ,  $j$  denotes an integer such that  $0 \leq j < |w|$ , and  $T(V)$  denotes an instance of a clocked or unclocked sequence that is passed the local variables  $V$  as actual arguments.

- $w^j, L_0, L_1 \models \text{ended}$  iff there exist  $0 \leq i \leq j$  and  $L$  such that both  $w^{i,j}, \{\}, L \models T(V)$  and  $L_1 = L_0 \upharpoonright_D \cup L_V$ , where  $D = \text{dom}(L_0) - (\text{dom}(L) \cap V)$ .
- $w^j, L_0, L_1 \models @ (c) (T(V).\text{matched})$  iff there exists  $0 \leq i < j$  such that  $w^i, L_0, L_1 \models T(V). \text{ended}$  and  $w^{i+1,j}, \{\}, \{\} \models (!c [*0:\$] \#\#1 c)$ .
- $w^j \models @ (c) \$\text{stable} (e)$  iff there exists  $0 \leq i < j$  such that  $w^{i,j}, \{\}, \{\} \models (c \#\#1 c [*->1])$  and  $e[w^i] = e[w^j]$ .
- $w^j \models @ (c) \$\text{rose} (e)$  iff  $b[w^j] = 1$  and (if there exists  $0 \leq i < j$  such that  $w^{i,j}, \{\}, \{\} \models (c \#\#1 c [*->1])$  then  $b[w^i] \neq 1$ ), where  $b$  is the least-significant bit of  $e$ .
- $w^j \models @ (c) \$\text{fell} (e)$  iff  $b[w^j] = 0$  and (if there exists  $0 \leq i < j$  such that  $w^{i,j}, \{\}, \{\} \models (c \#\#1 c [*->1])$  then  $b[w^i] \neq 0$ ), where  $b$  is the least-significant bit of  $e$ .

### H.4.2 Past

$w$  denotes a non-empty finite or infinite word over  $\Sigma$ , and  $j$  denotes an integer such that  $0 \leq j < |w|$ .

SVA 49

- Let  $n \geq 1$ . If there exist  $0 \leq i < j$  such that  $w^{i,j}, \{\}, \{\} \models (c \#\#1 c [*->n-1])$ , then  $@ (c) \$\text{past} (e, n) [w^j] = e[w^i]$ . Otherwise,  $@ (c) \$\text{past} (e, n) [w^j]$  has the value  $x$ .

SVA 50

LRM 209

- $\$\text{past} (e) \equiv \$\text{past} (e, 1)$ .

## H.5 Recursive Properties

LRM 130

This section defines the neutral semantics of instances of recursive properties in terms of the neutral semantics of instances of non-recursive properties. The latter can be expanded to properties in the abstract syntax by appropriate substitutions, and so their semantics is assumed to be understood.

According to Restriction 1 in Section 17.11.1, it is understood below that the negation operator **not** cannot be applied to any property expression that instantiates a recursive property. Restriction 2 in Section 17.11.1 is not represented here because **disable iff** is treated as a general property-building operator in this appendix. A

JH27

precise version of Restriction 3 is given below.

LRM 260

**Defined Named** property  $p$  is said to *depend* on **defined named** property  $q$  if there exist  $n \geq 0$  and **defined named** properties  $p_0, \dots, p_n$  such that  $p_0 = p$ ,  $p_n = q$ , and for all  $0 \leq i < n$ , the **definition declaration** of property  $p_i$  instantiates property  $p_{i+1}$ . In particular, by taking  $q = p$  and  $n = 0$ , it follows that property  $p$  depends on property  $p$ .

JH28

JH29

A **defined named** property  $p$  has an associated *dependency digraph*. The nodes of the digraph are all the **defined named** properties on which  $p$  depends. If  $q$  and  $r$  are nodes of the digraph, then there is an arc from  $q$  to  $r$  for each instance of  $r$  in the **definition declaration** of  $q$ . Such an arc is labelled by the minimum number of timesteps that are guaranteed from the beginning of the **definition declaration** of  $q$  until the particular instance  $r$ . For example, if  $q$  is **defined declared** by:

JH30

LRM 260

```
property q;
 (a |-> r)
 and
 ((b ##1 c [*0:3]) |=> r);
endproperty
```

JH31

where  $a$ ,  $b$ ,  $c$  are boolean expressions, then there is one arc from  $q$  to  $r$  labeled by “0” due to  $a \mid\text{-}\text{>} r$  and there is a second arc from  $q$  to  $r$  labeled by “2” due to  $(b \text{ ##1 } c \text{ [*0:3]}) \mid\text{=>} r$ .

A **defined named** property  $p$  is called *recursive* if its node appears on a cycle in the dependency digraph of  $p$ .

JH32

LRM 260

The following is a precise version of Restriction 3:

RESTRICTION 3: The sum of the arc labels around any cycle of the dependency digraph of a recursive property must be positive.

Let  $p(X)$  be an instance of a recursive **defined named** property  $p$ , where  $X$  denotes the actual arguments of the instance. For  $k \geq 0$ , the  $k$ -fold approximation to  $p(X)$ , denoted  $p[k](X)$ , is an instance of a non-recursive property  $p[k]$  defined inductively as follows.

LRM 260

- The **definition declaration** of  $p[0]$  is obtained from the **definition declaration** of  $p$  by replacing the body *property\_expr* with the literal  $1 \text{ ' } b1$ .
- For  $k > 0$ , the **definition declaration** of  $p[k]$  is obtained from the **definition declaration** of  $p$  by replacing each instance of a recursive property by its  $(k - 1)$ -fold approximation.

The semantics of the instance  $p(X)$  is then defined as follows. For any word  $w$  over  $\Sigma$  and local variable context  $L$ ,  $w, L \models p(X)$  iff for all  $k \geq 0$ ,  $w, L \models p[k](X)$ .

JH33

**Annex I**  
**sv\_vpi\_user.h**

LRM 183

(normative)

sv\_vpi\_user.h

LRM 209  
LRM 258  
LRM 281

```

/*****

* sv_vpi_user.h
*
* Accellera SystemVerilog VPI extensions.
*
* This file contains the constant definitions, structure definitions, and
* routine declarations used by the Verilog PLI procedural interface VPI
* access routines.
*
*****/

#ifndef SV_VPI_USER_H
#define SV_VPI_USER_H

#include <vpi_user.h>

#ifdef __cplusplus
extern "C" {
#endif

/***** OBJECT TYPES *****/
#define vpiPackage
#define vpiInterface
#define vpiProgram
#define vpiInterfaceArray
#define vpiProgramArray
#define vpiTypespec
#define vpiModport
#define vpiInterfaceTfDecl
#define vpiRefObj
#define vpiVarBitVar vpiRegBit
#define vpiLongIntVar
#define vpiShortIntVar
#define vpiIntVar
#define vpiShortRealVar
#define vpiByteVar
#define vpiClassVar
#define vpiStringVar
#define vpiEnumVar
#define vpiStructVar
#define vpiUnionVar
#define vpiBitVar
#define vpiLogicVar vpiRegVar
#define vpiArrayVar vpiRegArray
#define vpiLongIntTypespec
#define vpiShortRealTypespec
#define vpiByteTypespec
#define vpiShortIntTypespec
#define vpiIntTypespec
#define vpiClassTypespec

```



```
#define vpiStringTypespec
#define vpiVarBitTypespec
#define vpiEnumTypespec
#define vpiEnumConst
#define vpiIntegerTypespec
#define vpiTimeTypespec
#define vpiRealTypespec
#define vpiStructTypespec
#define vpiUnionTypespec
#define vpiBitTypespec
#define vpiLogicTypespec
#define vpiArrayTypespec
#define vpiVoidTypespec
#define vpiMemberTypespec
#define vpiClockingBlock
#define vpiClockingIODecl
#define vpiClassDefn
#define vpiConstraint
#define vpiConstraintOrdering
#define vpiConstraintDist
#define vpiDistItem
#define vpiAliasStmt
#define vpiThread
#define vpiMethodFuncCall
#define vpiMethodTaskCall
#define vpiAssertProperty
#define vpiAssumeProperty
#define vpiCoverProperty
#define vpiDisableCondition
#define vpiClockingEvent
#define vpiPropertyDecl
#define vpiPropertySpec
#define vpiPropertyExpr
#define vpiMulticlockSequenceExpr
#define vpiClockedSeq
#define vpiPropertyInst
#define vpiSequenceDecl
#define vpiSequenceSpec
#define vpiActualArgExpr
#define vpiSequenceInst
#define vpiImmediateAssert
#define vpiReturn
#define vpiAnyPattern
#define vpiTaggedPattern
#define vpiStructPattern
#define vpiDoWhile
#define vpiOrderedWait
#define vpiWaitFork
#define vpiDisableFork
#define vpiExpectStmt
#define vpiForeachStmt
#define vpiFinal

/***** METHODS *****/
/***** methods used to traverse 1 to 1 relationships *****/
#define vpiInterfaceConn
#define vpiTypedefAlias
#define vpiBaseTypespec
```

```
#define vpiElemTypespec
#define vpiDefInputSkew
#define vpiDefOutputSkew
#define vpiSkew
#define vpiBaseClass
#define vpiActualDefn
#define vpiLhs
#define vpiRhs
#define vpiOrigin
#define vpiPrefix
#define vpiWith
#define vpiSuccessStmt
#define vpiFailStmt
#define vpiProperty

/***** methods used to traverse 1 to many relationships *****/
#define vpiTypedef
#define vpiDefaultClocking
#define vpiInstance
#define vpiImport
#define vpiDerivedClasses
#define vpiMethods
#define vpiSolveBefore
#define vpiSolveAfter
#define vpiWeight
#define vpiWaitingProcesses
#define vpiMessages
#define vpiMembers
#define vpiLoopVars

/***** generic object properties *****/
#define vpiTop
#define vpiUnit
#define vpiAccessType
#define vpiForkJoin
#define vpiExtern
#define vpiDPIExtern
#define vpiDPIImport
#define vpiArrayType
#define vpiDynamicArray
#define vpiQueueArray
#define vpiStaticArray
#define vpiIsRandomized
#define vpiRandType
#define vpiVpiRand
#define vpiRandC
#define vpiNotRand
#define vpiConstantVar
#define vpiMember
#define vpiVisibility
#define vpiPublic
#define vpiProtected
#define vpiPrivate
#define vpiPacked
#define vpiTagged
```

```

#define vpiRef
#define vpiDefaultSkew
#define vpiVirtual
#define vpiUserDefined
#define vpiIsConstraintEnabled
#define vpiClassType
#define vpiMailbox
#define vpiSemaphore
#define vpiAssociativeArray
#define vpiIndexTypespec
#define vpiMethod
#define vpiValid
#define vpiActive
#define vpiIsClockInferred
#define vpiUniqueQualifier
#define vpiPriorityQualifier
#define vpiTaggedQualifier
#define vpiNullConst
#define vpiOneStepConst
#define VpiAlwaysType
#define vpiAlwaysComb
#define vpiAlwaysFF
#define vpiAlwaysLatch

v

/***** Operators *****/
#define vpiEqualDist /* constraint equal distribution operator */
#define vpiDivDist /* constraint divided distribution operator */

#define vpiImplyOp /* -> implication operator */
#define vpiNonOverlapImplyOp /* |=> non-overlapped implication */
#define vpiOverlapImplyOp /* |-> overlapped implication operator */

#define vpiUnaryCycleDelayOp /* binary cycle delay (##) operator */
#define vpiCycleDelayOp /* binary cycle delay (##) operator */
#define vpiIntersectOp /* intersection operator */
#define vpiFirstMatchOp /* first_match operator */
#define vpiThroughoutOp /* throughout operator */
#define vpiWithinOp /* within operator */
#define vpiRepeatOp /* [*=] non-consecutive repetition */
#define vpiConsecutiveRepeatOp /* [*] consecutive repetition */
#define vpiGotoRepeatOp /* [*->] goto repetition */

#define vpiPostIncOp /* ++ post-increment */
#define vpiPreIncOp /* ++ pre-increment */
#define vpiPostDecOp /* -- post-decrement */
#define vpiPreDecOp /* -- pre-decrement */

#define vpiMatchOp /* match() operator */
#define vpiCastOp /* type'() operator */
#define vpiIffOp /* iff operator */
#define vpiWildEqOp /* *=? operator */
#define vpiWildNeqOp /* !?= operator */

/***** STRUCTURE DEFINITIONS *****/

```

```

/***** structure *****/

/***** CALLBACK REASONS *****/
#define cbStartOfThread /* callback on thread creation */
#define cbEndOfThread /* callback on thread termination */
#define cbEnterThread /* callback on re-entering thread */
#define cbStartOfFrame /* callback on frame creation */
#define cbEndOfFrame /* callback on frame exit */
#define cbTypeChange /* callback on variable type/size
change */

/***** FUNCTION DECLARATIONS *****/

#ifdef __cplusplus
}
#endif

#endif

/*****
* sv_vpi_user.h
*
* Accellera SystemVerilog VPI extensions.
*
* This file contains the constant definitions, structure definitions, and
* routine declarations used by the Verilog PLI procedural interface VPI
* access routines.
*
*****/

/*****
* NOTE: The constant values 600 through 999 are reserved for use in this
* sv_vpi_user.h file. The range 800 through 899 is reserved for the reader
* VPI
*****/

#ifndef SV_VPI_USER_H
#define SV_VPI_USER_H

#include <vpi_user.h>

#ifdef __cplusplus
extern "C" {
#endif

/***** OBJECT TYPES *****/
#define vpiPackage 600
#define vpiInterface 601
#define vpiProgram 602
#define vpiInterfaceArray 603
#define vpiProgramArray 604
#define vpiTypespec 605
#define vpiModport 606
#define vpiInterfaceTfDecl 607
#define vpiRefObj 608
#define vpiVarBitVar vpiRegBit

```

|         |
|---------|
| LRM 209 |
| LRM 258 |
| LRM 281 |

```
#define vpiLongIntVar 609
#define vpiShortIntVar 610
#define vpiIntVar 611
#define vpiShortRealVar 612
#define vpiByteVar 613
#define vpiClassVar 614
#define vpiStringVar 615
#define vpiEnumVar 616
#define vpiStructVar 617
#define vpiUnionVar 618
#define vpiBitVar 619
#define vpiLogicVar vpiRegVar
#define vpiArrayVar vpiRegArray
#define vpiLongIntTypespec 620
#define vpiShortRealTypespec 621
#define vpiByteTypespec 622
#define vpiShortIntTypespec 623
#define vpiIntTypespec 624
#define vpiClassTypespec 625
#define vpiStringTypespec 626
#define vpiVarBitTypespec 627
#define vpiEnumTypespec 628
#define vpiEnumConst 629
#define vpiIntegerTypespec 630
#define vpiTimeTypespec 631
#define vpiRealTypespec 632
#define vpiStructTypespec 633
#define vpiUnionTypespec 634
#define vpiBitTypespec 635
#define vpiLogicTypespec 636
#define vpiArrayTypespec 637
#define vpiVoidTypespec 638
#define vpiMemberTypespec 639
#define vpiClockingBlock 640
#define vpiClockingIODecl 641
#define vpiClassDefn 642
#define vpiConstraint 643
#define vpiConstraintOrdering 644

#define vpiDistItem 645
#define vpiAliasStmt 646
#define vpiThread 647
#define vpiMethodFuncCall 648
#define vpiMethodTaskCall 649
#define vpiAssertProperty 650
#define vpiAssumeProperty 651
#define vpiCoverProperty 652
#define vpiDisableCondition 653
#define vpiClockingEvent 654
#define vpiPropertyDecl 655
#define vpiPropertySpec 656
#define vpiPropertyExpr 657
#define vpiMulticlockSequenceExpr 658
#define vpiClockedSeq 659
#define vpiPropertyInst 660
#define vpiSequenceDecl 661
#define vpiSequenceSpec 662
#define vpiActualArgExpr 663
#define vpiSequenceInst 664
```

```
#define vpiImmediateAssert 665
#define vpiReturn 666
#define vpiAnyPattern 667
#define vpiTaggedPattern 668
#define vpiStructPattern 669
#define vpiDoWhile 670
#define vpiOrderedWait 671
#define vpiWaitFork 672
#define vpiDisableFork 673
#define vpiExpectStmt 674
#define vpiForeachStmt 675
#define vpiFinal 676

#define vpiExtend 677
#define vpiDistribution 678
#define vpiIdentifier 679

/***** METHODS *****/
/***** methods used to traverse 1 to 1 relationships *****/
#define vpiInterfaceConn 680
#define vpiTypedefAlias 681
#define vpiIndexTypespec 682
#define vpiBaseTypespec 683
#define vpiElemTypespec 684
#define vpiDefInputSkew 685
#define vpiDefOutputSkew 686
#define vpiClockingSkew 687

#define vpiActualDefn 688
#define vpiLhs 689
#define vpiRhs 690
#define vpiOrigin 691
#define vpiPrefix 692
#define vpiWith 693

#define vpiProperty 694

#define vpiValueRange 695
#define vpiPattern 696
#define vpiWeight 697

/***** methods used to traverse 1 to many relationships *****/
#define vpiTypedef 698
#define vpiImport 699
#define vpiDerivedClasses 700
#define vpiMethods 701
#define vpiSolveBefore 702
#define vpiSolveAfter 703
#define vpiWaitingProcesses 704
#define vpiMessages 705
#define vpiMembers 706
#define vpiLoopVars 707

#define vpiConcurrentAssertions 708
#define vpiMatchItem 709
```

```
/****** methods both 1-1 and 1-many relations
******/
#define vpiInstance 710

/****** generic object properties ******/
#define vpiTop 600
#define vpiUnit 601

#define vpiAccessType 602
#define vpiForkJoinAcc 1
#define vpiExternAcc 2
#define vpiDPIExternAcc 3
#define vpiDPIImportAcc 4

#define vpiArrayType 603
#define vpiStaticArray 1
#define vpiDynamicArray 2
#define vpiAssocArray 3
#define vpiQueueArray 4

#define vpiIsRandomized 604

#define vpiRandType 605
#define vpiNotRand 1
#define vpiRand 2
#define vpiRandC 3

#define vpiConstantVariable 606
#define vpiMember 607

#define vpiVisibility 608
#define vpiPublicVis 1
#define vpiProtectedVis 2
#define vpiLocalVis 3

#define vpiPacked 609
#define vpiTagged 610
#define vpiRef 611
#define vpiDefaultSkew 612
#define vpiVirtual 613
#define vpiUserDefined 614
#define vpiIsConstraintEnabled 615

#define vpiClassType 616
#define vpiMailboxClass 1
#define vpiSemaphoreClass 2
#define vpiUserDefineClass 3

#define vpiMethod 617
#define vpiValid 618
#define vpiActive 619
#define vpiIsClockInferred 620

#define vpiQualifier 621
#define vpiUniqueQualifier 1
#define vpiPriorityQualifier 2
#define vpiTaggedQualifier 3
```

```

#define vpiNullConst 622
#define vpiOneStepConst 623

#define vpiAlwaysType 624
#define vpiAlwaysComb 1
#define vpiAlwaysFF 2
#define vpiAlwaysLatch 3

#define vpiDistType 625
#define vpiEqualDist 1 /* constraint equal distribution operator */
#define vpiDivDist 2 /* constraint divided distribution operator */

/***** Operators *****/

#define vpiImplyOp 50 /* -> implication operator */
#define vpiNonOverlapImplyOp 51 /* |=> non-overlapped implication */
#define vpiOverlapImplyOp 52 /* |-> overlapped implication operator */
#define vpiUnaryCycleDelayOp 53 /* binary cycle delay (##) operator */
#define vpiCycleDelayOp 54 /* binary cycle delay (##) operator */
#define vpiIntersectOp 55 /* intersection operator */
#define vpiFirstMatchOp 56 /* first_match operator */
#define vpiThroughoutOp 57 /* throughout operator */
#define vpiWithinOp 58 /* within operator */
#define vpiRepeatOp 59 /* [+*=] [=] non-consecutive repetition */
#define vpiConsecutiveRepeatOp 60 /* [*] consecutive repetition */
#define vpiGotoRepeatOp 61 /* [+*->] [->] goto repetition */

#define vpiPostIncOp 62 /* ++ post-increment */
#define vpiPreIncOp 63 /* ++ pre-increment */
#define vpiPostDecOp 64 /* -- post-decrement */
#define vpiPreDecOp 65 /* -- pre-decrement */

#define vpiMatchOp 66 /* match() operator */
#define vpiCastOp 67 /* type'() operator */
#define vpiIffOp 68 /* iff operator */
#define vpiWildEqOp 69 /* == operator */
#define vpiWildNeqOp 70 /* != operator */

#define vpiStreamLROp 71 /* the left-to-right streaming {>>} operator */
#define vpiStreamRLOp 72 /* the right-to-left streaming {<<} operator */

#define vpiMatchedOp 73 /* the .matched sequence operation */
#define vpiEndedOp 74 /* the .ended sequence operation */

/***** STRUCTURE DEFINITIONS *****/

/***** structure *****/

/***** CALLBACK REASONS *****/
#define cbStartOfThread 600 /* callback on thread creation */
#define cbEndOfThread 601 /* callback on thread termination */
#define cbEnterThread 602 /* callback on re-entering thread */
#define cbStartOfFrame 603 /* callback on frame creation */
#define cbEndOfFrame 604 /* callback on frame exit */
#define cbTypeChange 605 /* callback on variable type/size change */

/***** FUNCTION DECLARATIONS *****/

```



```

/*****/
/*****/

/***** Coverage VPI *****/
/* coverage has been assigned the numeric range 650-699 */

/* coverage control */
#define vpiCoverageStart 711
#define vpiCoverageStop 712
#define vpiCoverageReset 713
#define vpiCoverageCheck 714
#define vpiCoverageMerge 715
#define vpiCoverageSave 716
/* coverage type properties */
#define vpiAssertCoverage 717
#define vpiFsmStateCoverage 718
#define vpiStatementCoverage 719
#define vpiToggleCoverage 720
/* Coverage status properties */
#define vpiCovered 721
#define vpiCoverMax 722
#define vpiCoveredCount 723
/* Assertion-specific coverage status properties */
#define vpiAssertAttemptCovered 724
#define vpiAssertSuccessCovered 725
#define vpiAssertFailureCovered 726
/* FSM-specific coverage status properties */
#define vpiFsmStates 727
#define vpiFsmStateExpression 728
/* FSM handle types */
#define vpiFsm 729
#define vpiFsmHandle 730

/*****/
/*****/

/***** Assertion VPI *****/
/* assertions have been assigned the numeric range 700-799 */

/* assertion types */
#define vpiSequenceType 731
#define vpiAssertType 732
#define vpiCoverType 733
#define vpiPropertyType 734
#define vpiImmediateAssertType 735

/* assertion callback types */
#define cbAssertionStart 606
#define cbAssertionSuccess 607
#define cbAssertionFailure 608
#define cbAssertionStepSuccess 609
#define cbAssertionStepFailure 610
#define cbAssertionDisable 611
#define cbAssertionEnable 612
#define cbAssertionReset 613
#define cbAssertionKill 614
#define cbAssertionSysInitialized 615
#define cbAssertionSysStart 616

```

```

#define cbAssertionSysStop 617
#define cbAssertionSysEnd 618
#define cbAssertionSysReset 619

/* Assertion control constants */
#define vpiAssertionDisable 620
#define vpiAssertionEnable 621
#define vpiAssertionReset 622
#define vpiAssertionKill 623
#define vpiAssertionEnableStep 624
#define vpiAssertionDisableStep 625
#define vpiAssertionClockSteps 626
#define vpiAssertionSysStart 627
#define vpiAssertionSysStop 628
#define vpiAssertionSysEnd 629
#define vpiAssertionSysReset 630

/* Assertion related structs and types */
typedef struct t_vpi_source_info {
 PLI_BYTE8 *fileName;
 PLI_INT32 startLine;
 PLI_INT32 startColumn;
 PLI_INT32 endLine;
 PLI_INT32 endColumn;
} s_vpi_source_info, *p_vpi_source_info;

typedef struct t_vpi_assertion_info {
 PLI_BYTE8 *assertName; /* name of assertion */
 vpiHandle instance; /* instance containing assertion */
 PLI_BYTE8 defname; /* name of module/interface containing assertion */
 vpiHandle clock; /* clocking expression */
 PLI_INT32 assertionType; /* vpiSequenceType, vpiAssertType,
vpiCoverType,
 vpiPropertyType, vpiImmediateAssertType */
 s_vpi_source_info sourceInfo;
} s_vpi_assertion_info, *p_vpi_assertion_info;

typedef struct t_vpi_assertion_step_info {
 PLI_INT32 matched_expression_count;
 vpiHandle *matched_exprs; /* array of expressions */
 p_vpi_source_info *exprs_source_info; /* array of source info */
 PLI_INT32 stateFrom, stateTo; /* identify transition */
} s_vpi_assertion_step_info, *p_vpi_assertion_step_info;

typedef struct t_vpi_attempt_info {
 union {
 vpiHandle failExpr;
 p_vpi_assertion_step_info step;
 } detail;
 s_vpi_time attemptStartTime; /* Time attempt triggered */
} s_vpi_attempt_info, *p_vpi_attempt_info;

/* typedef for vpi_register_assertion_cb callback function */
typedef PLI_INT32 (vpi_assertion_callback_func) (
 PLI_INT32 reason, /* callback reason */
 p_vpi_time cb_time, /* callback time */
 vpiHandle assertion, /* handle to assertion */

```

```

 p_vpi_attempt_info info, /* attempt related information */
 PLI_BYTE8 *user_data /* user data entered upon registration */
);

/* assertion specific VPI functions */
PLI_INT32 vpi_get_assertion_info (assert_handle, p_vpi_assertion_info);

vpiHandle vpi_register_assertion_cb(
 vpiHandle assertion, /* handle to assertion */
 PLI_INT32 reason, /* reason for which callbacks needed */
 vpi_assertion_callback_func *cb_rtn,
 PLI_BYTE8 *user_data /* user data to be supplied to cb */
);

/*****
/*****
/***** Reader VPI *****/
/* reader VPI has been assigned the numeric range 800-899 */

/***** Reader types *****/
#define vpiTrvsObj 800 /* Data traverse object */
#define vpiCollection 810 /* Collection of VPI handle */
#define vpiObjCollection 811 /* Collection of traversable design
objs */
#define vpiTrvsCollection 812 /* Collection of vpiTrvsObjs */

/***** Reader methods *****/

/* Check */
#define vpiIsLoaded 820 /* Object data is loaded check */
#define vpiHasDataVC 821 /* Traverse object has at least one
VC at some point
* in time in the database check */
#define vpiHasVC 822 /* Has VC at specific time check */
#define vpiHasNoValue 823 /* Has no value at specific time check */
#define vpiBelong 824 /* Belongs to extension check */

/* Access */
#define vpiAccessLimitedInteractive 830 /* Interactive access */
#define vpiAccessInteractive 831 /* interactive with history access */
#define vpiAccessPostProcess 832 /* Database access */
/* Member of a collection */
#define vpiMember 840 /* Member of a collection */
/* Iteration on instances for loaded */
#define vpiDataLoaded 850 /* Use in vpi_iterate() */

/* Control Traverse/Check Time */
#define vpiMinTime 860 /* Min time */
#define vpiMaxTime 864 /* Max time */
#define vpiPrevVC 868 /* Previous Value Change (VC) */
#define vpiNextVC 870 /* Next Value Change (VC) */
#define vpiTime 874 /* Time jump */

/***** routines *****/

```

```
PLI_INT32 vpi_load_extension PROTO_PARAMS((PLI_BYTE8 *extension_name, ...)) /* In
its general form */

/***** Reader routines *****/
PLI_INT32 vpi_load_extension PROTO_PARAMS((PLI_BYTE8 *extension_name,
 PLI_BYTE8 *name,
 vpiType mode, ...)) /* for the reader
extension */

PLI_INT32 vpi_close PROTO_PARAMS((PLI_INT32 tool, vpiType prop, PLI_BYTE8* name));
PLI_INT32 vpi_load_init PROTO_PARAMS((vpiHandle objCollection, vpiHandle scope,
PLI_INT32 level));
PLI_INT32 vpi_load PROTO_PARAMS((vpiHandle h));
PLI_INT32 vpi_unload PROTO_PARAMS((vpiHandle h));
vpiHandle vpi_create PROTO_PARAMS((vpiType prop, vpiHandle h, vpiHandle obj));
vpiHandle vpi_goto PROTO_PARAMS((vpiType prop, vpiHandle obj, p_vpi_time time_p,
PLI_INT32 *ret_code));
vpiHandle vpi_filter PROTO_PARAMS((vpiHandle h, PLI_INT32 ft, PLI_INT32 flag));

#ifdef __cplusplus
}
#endif

#endif
```

## Annex J Glossary

(Informative)

**Aggregate** — An aggregate expression, variable or type represents a set or collection of singular values. An aggregate type is any unpacked structure, unpacked union, or unpacked array data type. Aggregates may be copied or compared as a whole, but not typically used in an expression as a whole.

LRM 235

**Assertion** — An assertion is a statement that a certain property must be true. For example, that a `read_request` must always be followed by a `read_grant` within 2 clock cycles. Assertions allow for automated checking that the specified property is true, and can generate automatic error messages if the property is not true. SystemVerilog provides special assertion constructs, which are discussed in Section 17.

**Bit-stream** — A bit-stream type or variables any type that can be represented as a serial stream of bits. To qualify as a bit-stream type, each and every bit of the type must be individually addressable. This means that a bit-stream type can be any type that does not include a `handle`, `chandle`, `real`, `shortreal`, or `event`.

**Canonical representation** — A data representation format established by convention into which and from which translations can be made with specialized representations.

**Constant** — There are two types of constants in SystemVerilog. Parameters and `localparam` are elaboration constants. Their values are calculated before elaboration is complete. Elaboration constants can be used to set the range of array types. The other form of constant is a run-time constant. These are variables that can only be set in an initialization expression using the `const` qualifier.

**Context imported task** — A DPI imported task declared with the 'context' property that is capable of calling exported tasks or functions and capable of accessing System Verilog objects via VPI or PLI calls.

**Disable protocol** — A set of conventions for setting, checking and handling disable status.

**DPI** — Direct Programming Interface. This is an interface between SystemVerilog and foreign programming languages permitting direct function calls from SystemVerilog to foreign code and from foreign code to SystemVerilog. It has been designed to have low inherent overhead and permit direct exchange of data between SystemVerilog and foreign code.

**Dynamic** — A dynamic type or variable is one that can be resized or re-allocated at runtime. Dynamic types include those that contain dynamic arrays, associative arrays, queues, or class handles.

**Elaboration** — Elaboration is the process of binding together the components that make up a design. These components can include module instances, primitive instances, interfaces, and the top-level of the design hierarchy.

**Enumerated type** — Enumerated data types provide the capability to declare a variable which can have one of a set of named values. The numerical equivalents of these values can be specified. Enumerated types can be easily referenced or displayed using the enumerated names, as opposed to the enumerated values. Section 3.10 discusses enumerated types.

**Exported task** — A System Verilog task that is declared in an export declaration and can be enabled from an imported task.

**Imported task** — A DPI foreign code subprogram that can call exported tasks and can directly or indirectly consume simulation time.

**Interface** — An interface encapsulates the communication between blocks of a design, allowing a smooth migration from abstract system-level design through successive refinement down to lower-level register-transfer and structural views of the design. By encapsulating the communication between blocks, the interface construct also facilitates design re-use. The inclusion of interface capabilities is one of the major advantages of SystemVerilog. Interfaces are covered in Section 19.

**Integral** — An integral expression, variable or type is used to represent integral, or integer value. They may also be called vectored values. Integrals may be signed or unsigned, sliced into smaller integral values, or concatenated into larger values.

**LRM** — LRM is an abbreviation for Language Reference Manual. “SystemVerilog LRM” refers to this document. “Verilog LRM” refers to the IEEE manual “1364-2001 IEEE Standard for Verilog Hardware Description Language 2001”. See Annex K for information about this manual.

**Open array** — A DPI array formal argument for which the packed or unpacked dimension size (or both) is not specified and for which interface routines describe the size of corresponding actual arguments at runtime.

**Packed array** — Packed array refers to an array where the dimensions are declared before an object name. Packed arrays can have any number of dimensions. A one-dimensional packed array is the same as a vector width declaration in Verilog. Packed arrays provide a mechanism for subdividing a vector into subfields, which can be conveniently accessed as array elements. A packed array differs from an unpacked array, in that the whole array is treated as a single vector for arithmetic operations. Packed arrays are discussed in detail in Section 4.

**Process** — A process is a thread of one or more programming statements which can be executed independently of other programming statements. Each initial procedure, always procedure and continuous assignment statement in Verilog is a separate process. These are static processes. That is, each time the process starts running, there is an end to the process. SystemVerilog adds specialized always procedures, which are also static processes, and dynamic processes. When dynamic processes are started, they can run without ending. Processes are presented in Section 9.

**Signal** — A signal is an informal term, usually meaning either a variable or net. The context where it is used may imply further restrictions on allowed types.

**Singular** — A singular expression, variable or type represents a single value, symbol, or handle. A singular type is any type except an unpacked structure, unpacked union, or unpacked array data type.

**SystemVerilog** — SystemVerilog refers to the Accellera standard for a set of abstract modeling and verification extensions to the IEEE 1364-2001 Verilog standard. The many features of the SystemVerilog standard are presented in this document.

**Unpacked array** — Unpacked array refers to an array where the dimensions are declared after an object name. Unpacked arrays are the same as arrays in Verilog, and can have any number of dimensions. An unpacked array differs from a packed array, in that the whole array cannot be used for arithmetic operations. Each element must be treated separately. Unpacked arrays are discussed in Section 4.

**Verilog** — Verilog refers to the IEEE 1364-2001 Verilog Hardware Description Language (HDL), commonly called Verilog-2001. This language is documented in the IEEE manual “1364-2001 IEEE Standard for Verilog Hardware Description Language 2001”. See Annex K for information about this manual.

**VPI** — Verilog Procedural Interface. The 3rd generation Verilog Programming Language Interface (PLI), providing object-oriented access to Verilog behavioral, structural, assertion and coverage objects.

## Annex K Bibliography

(Informative)

[B1] IEEE Std. 754-1985, IEEE Standard for Binary Floating-Point Arithmetic 1985. ISBN 1-5593-7653-8. IEEE Product No. SH10116-TBR.

[B2] IEEE Std. 1364-1995, IEEE Standard Hardware Description Language Based on the Verilog<sup>®</sup> Hardware Description Language 1995. ISBN 0-7381-3065-6. IEEE Product No. WE94418-TBR.

[B3] IEEE Std. 1364-2001, IEEE Standard for Verilog Hardware Description Language 2001. ISBN 0-7381-2827-9. IEEE Product No. SH94921-TBR.





## Index

### Symbols

!?= wild inequality operator **65**  
 ## expression operator **212**  
 #1step **180**  
 \$, as unbounded range **337–338, 342**  
 \$assertkill **345**  
 \$assertoff **345**  
 \$asserton **345**  
 \$bits **29, 341**  
 \$bitstoshortreal **29**  
 \$cast **30**  
 \$cast() **123**  
 \$countones **239**  
 \$coverage\_control **381**  
 \$dimensions **37, 343**  
 \$error **202, 345**  
 \$exit **199**  
 \$fatal **202, 345**  
 \$fell **216**  
 \$get\_coverage **333**  
 \$high **37, 343**  
 \$increment **37, 343**  
 \$info **202, 345**  
 \$isunbounded **342**  
 \$isunknown **238, 346**  
 \$left **37, 343**  
 \$load\_coverage\_db **333**  
 \$low **37, 343**  
 \$onehot **238, 346**  
 \$onehot0 **238, 346**  
 \$past **216**  
 \$readmemb **347, 350**  
 \$readmemh **347, 350**  
 \$right **37, 343**  
 \$root **274, 287**  
 \$rose **216**  
 \$sampled **216**  
 \$set\_coverage\_db\_name **333**  
 \$shortrealtobits **29**  
 \$size **37, 343**  
 \$stable **216**  
 \$typename **341**  
 \$typeof **340**  
 \$unit **273**  
 \$urandom **156**  
 \$urandom\_range **156**  
 \$warning **202, 345**  
 \$writememb **348, 350**  
 \$writememh **348, 350**  
 %= assignment operator **64**  
 &= assignment operator **64**

\* expression operator **212**  
 \*= assignment operator **64, 66**  
 \*= expression operator **212**  
 \*-> expression operator **212**  
 += assignment operator **64, 66**  
 .\* port connections **283**  
 .name port connections **282**  
 /= assignment operator **64, 66**  
 :: scope operator **126, 156**  
 := weight operator **163**  
 <<<= assignment operator **64**  
 <<= assignment operator **64**  
 -= assignment operator **64, 66**  
 => implication operator **139**  
 ==?= wild equality operator **65**  
 >>= assignment operator **64**  
 >>>= assignment operator **64**  
 ?: conditional operator **79**  
 \ line continuation **352**  
 \a bell **6**  
 \f form feed **6**  
 \v vertical tab **6**  
 \x02 hex number **6**  
 ^= assignment operator **64**  
 ‘ ‘ double back tick **352**  
 ‘cast operator **29**  
 ‘define **352**  
 ‘SV\_COV\_CHECK **379**  
 ‘SV\_COV\_ERROR **379**  
 ‘SV\_COV\_HIER **380**  
 ‘SV\_COV\_NOCOV **379**  
 ‘SV\_COV\_OK **379**  
 ‘SV\_COV\_PARTIAL **379**  
 ‘SV\_COV\_RESET **379**  
 ‘SV\_COV\_START **379**  
 ‘SV\_COV\_STOP **379**  
 ‘SV\_MODULE\_COV **380**  
 |= assignment operator **64**

### Numerics

2-state types **11**  
 4-state types **11**

### A

active region **180**  
 aggregate expressions **74**  
 aggregate types **28**  
 alias **58**  
 always @\* **97**  
 always\_comb **97–98**  
 always\_ff **97–98**  
 always\_latch **97–98**  
 and **212, 218–219**  
 and() **53**

- anding sequences **218**
  - array literals **7**
  - array locator methods **50**
    - find() **51**
    - find\_first() **51**
    - find\_first\_index() **51**
    - find\_index() **51**
    - find\_last() **51**
    - find\_last\_index() **51**
    - max() **51**
    - min() **51**
    - unique() **51**
    - unique\_index() **51**
  - array ordering methods
    - reverse() **52**
    - rsort() **52**
    - shuffle() **52**
    - sort() **52**
  - array part selects **37**
  - array querying functions **37, 343**
  - array reduction methods
    - and() **53**
    - or() **53**
    - product() **52**
    - sum() **52**
    - xor() **53**
  - array slices **36**
  - arrays **34**
  - assert **201, 254**
  - assertion API **368–376**
  - assertion system functions **346**
  - assertion system tasks **344–345**
  - assertions **201–239, 567**
  - assign **81, 96, 354**
  - assignment compatible types **61**
  - assignment operators **64**
  - associative array methods
    - delete() **44**
    - exists() **44**
    - first() **45**
    - last() **45**
    - next() **45**
    - num() **44**
    - prev() **46**
  - associative arrays **41–47**
  - assume **254–255**
  - atobin() **16**
  - atohex() **16**
  - atoi() **16**
  - atooct() **16**
  - atoreal() **16**
  - attributes **63**
  - auto\_bin\_max **320**
  - automatic **54, 56–57, 104**
  - automatic tasks **106**
  - await() **102**
- ## B
- back() **505**
  - before **136**
  - bell **6**
  - bind **75, 266**
  - bins **320–324**
  - binsof **326, 328**
  - bintoa() **17**
  - bit **9, 11**
  - bit-stream casting **31**
  - block name **92**
  - blocking assignments **82**
  - boolean expression **207**
  - break **81, 91, 93, 165**
  - built-in methods **67**
  - built-in package **68, 500**
  - byte **11**
- ## C
- case **164**
  - case statements, pattern matching **85**
  - cast compatible types **62**
  - casting **29–30**
  - casting, bit-stream **31**
  - chandle **9, 12, 117**
  - check **202**
  - class **27, 114–130**
  - clear() **507**
  - clock tick **203**
  - clocking blocks **299, 311**
  - combinational logic **97**
  - compare() **15**
  - compilation unit **273–274**
  - concatenation **69**
  - concurrent assertions **203**
  - conditional operator rules **79**
  - configurations **339**
  - const **54, 124**
  - constants **54**
  - constraint blocks **135**
  - constraint\_mode() **133, 152**
  - context **113, 358–360**
  - continue **81, 91, 93**
  - continuous assignment **98**
  - cover **254, 256–257**
  - coverage **314–334**
  - coverage API **377–389**
  - coverage options **328**
  - covergroup **315–334**
  - coverpoint **324, 328**
  - cross **324–325, 328**

## D

- data declarations **54**
- data type compatibility **60**
- data type equivalence **60**
- data types **9**
- data() **504**
- deassign **81, 96, 354**
- decrement operator **64**
- defparam **335, 354**
- delete() **39, 44, 49**
- Direct Programming Interface (DPI) **356–366**
- disable **93, 366**
- disable fork **97, 101**
- disable iff **543**
- dist **136, 138**
- distribution **138**
- do...while loop **81, 89**
- double **12**
- dynamic array methods
  - delete() **39**
  - size() **38**
- dynamic arrays **37**
- dynamic processes **97**

## E

- elaboration **567**
- empty() **504**
- encapsulation **124**
- enum **19**
- enumerated type methods
  - first() **22**
  - last() **22**
  - name() **23**
  - next() **23**
  - num() **23**
  - prev() **23**
- enumerated types **19, 567**
- eq() **503**
- equivalent data types **60**
- erase() **506**
- erase\_range() **506**
- exists() **44**
- expect **267**
- export **112, 300, 366**
- extends **123**
- extern **127, 300, 304**

## F

- final **81, 91**
- find() **51**
- find\_first() **51**
- find\_first\_index() **51**
- find\_index() **51**
- find\_last() **51**

- find\_last\_index() **51**
- finish() **505**
- FINISHED process status **102**
- first() **22, 45**
- first\_match **225**
- float **12**
- for loops **89**
- force **81**
- foreach **141**
- fork...join **99**
- fork...join\_any **56**
- fork...join\_none **56**
- forkjoin **288, 300, 304**
- form feed **6**
- front() **505**
- functions **107**
- functions, arg passing by name **111**
- functions, default args **110**
- functions, exporting **112, 300, 366**
- functions, importing **112, 300, 361**
- functions, in interfaces **300**

## G

- garbage collection **118**
- get\_randstate() **157**
- getc() **15**
- goto **91**

## H

- handle **117**
- hextoa() **16**
- hierarchical names **287**

## I

- icompare() **15**
- if statements, pattern matching **87**
- if...else **139, 163**
- iff **94, 204, 319, 325**
- ignore\_bins **324, 328**
- illegal\_bins **324, 328**
- immediate assertions **201**
- implication **139**
- import **112, 300, 361**
- inactive region **180**
- increment operator **64**
- inheritance **121, 137**
- insert() **49, 505**
- insert\_range() **506**
- int **9, 11**
- integer **11**
- integer literals **6**
- integral **11**
- interface **288–313, 567**
- interfaces, virtual **308–313**
- interleaving **165**

intersect **212, 221, 326**  
 introduction to SystemVerilog **1**  
 iterative constraints **140**  
 itoa() **16**

**J**

join\_any **97, 99**  
 join\_none **97, 99**

**K**

kill() **102**  
 KILLED process status **102**

**L**

labels **92**  
 last() **22, 45**  
 latched logic **98**  
 len() **15**  
 libraries **339**  
 library map files **339**  
 linked lists **502–507**  
 list methods  
   back() **505**  
   clear() **507**  
   data() **504**  
   empty() **504**  
   eq() **503**  
   erase() **506**  
   erase\_range() **506**  
   finish() **505**  
   front() **505**  
   insert() **505**  
   insert\_range() **506**  
   neq() **504**  
   next() **503**  
   pop\_back() **505**  
   pop\_front() **505**  
   prev() **503**  
   purge() **507**  
   push\_back() **504**  
   push\_front() **504**  
   set() **506**  
   size() **504**  
   start() **505**  
   swap() **507**  
 literal values **5**  
 local **124**  
 localparam **335**  
 logic **9, 11**  
 longest static prefix **68**  
 longint **9, 11**  
 LRM **568**

**M**

mailbox **500**

matched **252**  
 matches **85–88**  
 max() **51**  
 memory management **130**  
 methods **118**  
   and() **53**  
   atobin() **16**  
   atohex() **16**  
   atoi() **16**  
   atooct() **16**  
   atoreal() **16**  
   await() **102**  
   back() **505**  
   bintoa() **17**  
   clear() **507**  
   compare() **15**  
   constraint\_mode() **133, 152**  
   data() **504**  
   delete() **39, 44, 49**  
   empty() **504**  
   eq() **503**  
   erase() **506**  
   erase\_range() **506**  
   exists() **44**  
   find() **51**  
   find\_first() **51**  
   find\_first\_index() **51**  
   find\_index() **51**  
   find\_last() **51**  
   find\_last\_index() **51**  
   finish() **505**  
   first() **22, 45**  
   front() **505**  
   get\_randstate() **157**  
   getc() **15**  
   hextoa() **16**  
   icompare() **15**  
   insert() **49, 505**  
   insert\_range() **506**  
   itoa() **16**  
   kill() **102**  
   last() **22, 45**  
   len() **15**  
   max() **51**  
   min() **51**  
   name() **23**  
   neq() **504**  
   new() **38**  
   next() **23, 45, 503**  
   num() **23, 44**  
   octtoa() **16**  
   or() **53**  
   pop\_back() **49, 505**  
   pop\_front() **49, 505**

post\_randomize() **133, 149**  
 pre\_randomize() **133, 149**  
 prev() **23, 46, 503**  
 process() **500**  
 product() **52**  
 purge() **507**  
 push\_back() **50, 504**  
 push\_front() **49, 504**  
 putc() **15**  
 rand\_mode() **133, 151**  
 randomize() **131, 148, 500**  
 realtoa() **17**  
 resume() **102**  
 reverse() **52**  
 rsort() **52**  
 self() **102**  
 set() **506**  
 set\_randstate() **157**  
 shuffle() **52**  
 sie() **504**  
 size() **38, 49**  
 sort() **52**  
 start() **505**  
 status() **102**  
 substr() **16**  
 sum() **52**  
 suspend() **102**  
 swap() **507**  
 tolower() **15**  
 toupper() **15**  
 unique() **51**  
 unique\_index() **51**  
 xor() **53**  
 methods, built-in **67**  
 min() **51**  
 modport **288, 294**  
 modport expressions **298**  
 module instantiation **282–283**  
 multiple dimension arrays **36**

**N**

name() **23**  
 named blocks **92**  
 named port connections **282**  
 NBA region **180**  
 neq() **504**  
 nested identifiers **287**  
 nested modules **275**  
 new **118**  
 next() **23, 45, 503**  
 nonblocking assignments **82**  
 null **12, 17, 130**  
 num() **23, 44**

**O**

object handle **116–117**  
 object-oriented **114**  
 observed region **180**  
 octtoa() **16**  
 operator associativity **66**  
 operator overloading **74**  
 operator precedence **66, 212**  
 operators, streaming **76–79**  
 or **212, 223**  
 or() **53**  
 oring sequences **223**  
 overview of SystemVerilog **1**

**P**

pack **76**  
 packages **269–273**  
 packed arrays **34–36, 65, 568**  
 parameter **128, 335–338**  
 parameter type **336**  
 part selects **37**  
 pattern matching **84–88**  
 PLI callbacks **183**  
 pointer **117**  
 polymorphism **126**  
 pop\_back() **49, 505**  
 pop\_front() **49, 505**  
 port connections, .\* **283**  
 port connections, .name **282**  
 port declarations **278**  
 port expressions **279**  
 post\_randomize() **133, 149**  
 post-NBA region **180**  
 post-observed region **180**  
 postponed region **180**  
 pre\_randomize() **133, 149**  
 pre-active region **180**  
 precedence **66**  
 pre-NBA region **180**  
 preponed region **180**  
 prev() **23, 46, 503**  
 priority **83–84**  
 process **568**  
 process control **100, 102**  
 process execution threads **100**  
 process methods
 

- await() **102**
- kill() **102**
- resume() **102**
- self() **102**
- status() **102**
- suspend() **102**

 process() **500**  
 processes **102**

product() **52**  
 program block **196–200**  
 property **204, 239**  
 protected **124**  
 pure **112, 358–359**  
 purge() **507**  
 push\_back() **50, 504**  
 push\_front() **49, 504**  
 putc() **15**

**Q**

queue methods  
   delete() **49**  
   insert() **49**  
   pop\_back() **49**  
   pop\_front() **49**  
   push\_back() **50**  
   push\_front() **49**  
   size() **49**  
 queues **47–50**

**R**

rand **134**  
 rand join **165**  
 rand\_mode() **133, 151**  
 randc **134**  
 randcase **160**  
 random constraints **131–160**  
 random distribution **138**  
 random implication **139**  
 Random Number Generator (RNG) **158**  
 randomization methods **157**  
   constraint\_mode() **133, 152**  
   post\_randomize() **133, 149**  
   pre\_randomize() **133, 149**  
   rand\_mode() **133, 151**  
   randomize() **131, 148, 500**  
   set\_randstate() **157**  
 randomize() **131, 148, 500**  
 randomize()...with **150**  
 randsequence **161–168**  
 range system function **342**  
 reactive region **180**  
 real **6, 9, 12**  
 real literals **6**  
 real, operations on **66**  
 realtoa() **17**  
 recursive properties **552**  
 reentrancy, DPI **359**  
 ref **110**  
 reg **9, 11**  
 regions  
   active **180**  
   inactive **180**

NBA **180**  
 observed **180**  
 post-NBA **180**  
 post-observed **180**  
 postponed **180**  
 pre-active **180**  
 pre-NBA **180**  
 preponed **180**  
 reactive **180**

release **81**  
 repeat **164**  
 repetition **212**  
 resume() **102**  
 return **81, 91, 93, 106, 108, 165**  
 reverse() **52**  
 RNG (Random Number Generator) **158**  
 rsort() **52**  
 RUNNING process status **102**

**S**

scheduling semantics **179–183**  
 self() **102**  
 semaphore **500**  
 sequence **207, 209**  
 sequence expression **207**  
 sequential logic **98**  
 set() **506**  
 set\_randstate() **157**  
 sets **79**  
 shortint **11**  
 shortreal **6, 9, 12**  
 shortreal, operations on **66**  
 shuffle() **52**  
 signed types **11**  
 singular types **28**  
 size() **38, 49, 504**  
 slices **36**  
 solve...before **136, 143**  
 sort() **52**  
 sparse arrays, see associative arrays  
 specify block **300**  
 specparam **335**  
 start() **505**  
 statement labels **92**  
 static **54–57, 104, 119**  
 static processes **97**  
 static tasks **106**  
 static, longest static prefix **68**  
 status() **102**  
 std **68, 154, 169, 500–501**  
 step **6, 180, 186, 280**  
 stratified event scheduler **179**  
 streaming operators **76–79**  
 string **13–17**

string literals **6**  
string methods  
  atobin() **16**  
  atohex() **16**  
  atoi() **16**  
  atooct() **16**  
  atoreal() **16**  
  bintoa() **17**  
  compare() **15**  
  getc() **15**  
  hextoa() **16**  
  icompare() **15**  
  itoa() **16**  
  len() **15**  
  octtoa() **16**  
  putc() **15**  
  realtoa() **17**  
  substr() **16**  
  tolower() **15**  
  toupper() **15**  
strobe **316**  
struct **24**  
structure literals **7**  
structures **24**  
subclasses **121**  
substr() **16**  
sum() **52**  
super **122**  
suspend() **102**  
SUSPENDED process status **102**  
swap() **507**  
SystemVerilog, overview **1**  
SystemVerilog, version numbers **1**

## T

tagged **26, 72–73, 85**  
tasks **105**  
tasks, arg pass by name **111**  
tasks, default args **110**  
tasks, in interfaces **300**  
this **120**  
threads **100**  
throughout **212**  
time **11**  
time literals **6**  
time unit **6**  
tolower() **15**  
top level **274**  
toupper() **15**  
type **336**  
type compatibility **60**  
typedef **9, 17, 129**  
typename function **340**  
typeof function **340**

## U

unbounded range **337–338**  
union **24**  
unions **24**  
unique **83–84**  
unique() **51**  
unique\_index() **51**  
unpack **76**  
unpacked arrays **34–36, 568**  
unsigned types **11**  
unsized literals **6**  
user-defined types **17**

## V

variable initialization **55**  
VCD **351**  
vertical tab **6**  
virtual **124–125, 308–313**  
void **12**  
void functions **104, 108**  
VPI **390–414**  
VPI object diagrams **415–456**  
vpi\_control **389**

## W

wait fork **97, 100**  
WAITING process status **102**  
while **81, 89**  
wildcard **323**  
wild-card operators **65**  
with **50, 52, 150**  
within **212**

## X

xor() **53**







